

**Agilent InfiniiVision
6000 Series
Oscilloscopes**

User's Guide

Notices

© Agilent Technologies, Inc. 2005-2008

No part of this manual may be reproduced in any form or by any means (including electronic storage and retrieval or translation into a foreign language) without prior agreement and written consent from Agilent Technologies, Inc. as governed by United States and international copyright laws.

Manual Part Number

54684-97030

Edition

Eleventh Edition, December 2008

Printed in Malaysia

Agilent Technologies, Inc.
395 Page Mill Road
Palo Alto, CA 94303 USA

A newer version of this manual may be available at

www.agilent.com/find/6000

Software Revision

This guide was written for version 5.20 of the Agilent InfiniiVision 6000 Series Oscilloscope software.

Trademark Acknowledgments

Java is a U.S. trademark of Sun Microsystems, Inc.

Sun, Sun Microsystems, and the Sun Logo are trademarks or registered trademarks of Sun Microsystems, Inc. in the U.S. and other countries.

Windows and MS Windows are U.S. registered trademarks of Microsoft Corporation.

Warranty

The material contained in this document is provided “as is,” and is subject to being changed, without notice, in future editions. Further, to the maximum extent permitted by applicable law, Agilent disclaims all warranties, either express or implied, with regard to this manual and any information contained herein, including but not limited to the implied warranties of merchantability and fitness for a particular purpose. Agilent shall not be liable for errors or for incidental or consequential damages in connection with the furnishing, use, or performance of this document or of any information contained herein. Should Agilent and the user have a separate written agreement with warranty terms covering the material in this document that conflict with these terms, the warranty terms in the separate agreement shall control.

Technology Licenses

The hardware and/or software described in this document are furnished under a license and may be used or copied only in accordance with the terms of such license.

Restricted Rights Legend

If software is for use in the performance of a U.S. Government prime contract or subcontract, Software is delivered and licensed as “Commercial computer software” as defined in DFAR 252.227-7014 (June 1995), or as a “commercial item” as defined in FAR 2.101(a) or as “Restricted computer software” as defined in FAR 52.227-19 (June 1987) or any equivalent agency regulation or contract clause. Use, duplication or disclosure of Software is subject to Agilent Technologies’ standard commercial license terms, and non-DOD Departments and Agencies of the U.S. Government will

receive no greater than Restricted Rights as defined in FAR 52.227-19(c)(1-2) (June 1987). U.S. Government users will receive no greater than Limited Rights as defined in FAR 52.227-14 (June 1987) or DFAR 252.227-7015 (b)(2) (November 1995), as applicable in any technical data.

Safety Notices

CAUTION

A **CAUTION** notice denotes a hazard. It calls attention to an operating procedure, practice, or the like that, if not correctly performed or adhered to, could result in damage to the product or loss of important data. Do not proceed beyond a **CAUTION** notice until the indicated conditions are fully understood and met.

WARNING

A **WARNING** notice denotes a hazard. It calls attention to an operating procedure, practice, or the like that, if not correctly performed or adhered to, could result in personal injury or death. Do not proceed beyond a **WARNING** notice until the indicated conditions are fully understood and met.

In This User's Guide...

This guide shows you how to use the Agilent InfiniiVision 6000 Series oscilloscopes. It contains the following chapters and topics:

- 1 Getting Started**
Unpacking and setting up your oscilloscope, using Quick Help.
- 2 Front-Panel Controls**
A quick overview of the front-panel controls.
- 3 Viewing and Measuring Digital Signals**
How to connect and use the digital channels of a mixed-signal oscilloscope (MSO).
- 4 Triggering the Oscilloscope**
Trigger modes, coupling, noise rejection, holdoff, external trigger and more. Edge, pulse width, and pattern triggering. CAN, duration, I²C, Nth Edge Burst, LIN, sequence, SPI, TV/video, and USB triggering modes.
- 5 Making Measurements**
XY mode, FFTs, math functions, using cursors, automatic measurements.
- 6 Displaying Data**
Using pan and zoom; normal, average, peak detect, and high resolution (smoothing) modes; noise rejection modes, glitch capture, and more.
- 7 Saving and Printing Data**
Printing waveforms, saving setups and data, and using the file explorer.
- 8 Reference**
Upgrading a DSO to an MSO, adding memory, software updates, I/O, synchronizing instruments with the 10 MHz reference clock, warranty status, digital signal probing, and more.
- 9 Power and Environmental Conditions**
Specifications and characteristics of the oscilloscope.

The Agilent InfiniiVision 6000 Series oscilloscopes deliver powerful features and high performance:

- 100 MHz, 300 MHz, 500 MHz, and 1 GHz bandwidth models.
- Up to 4 GSa/s sample rate.
- Powerful triggering including analog HDTV, I²C, SPI, LIN, CAN, and USB.
- USB, LAN, and GPIB ports make printing, saving and sharing data easy.
- 2-channel and 4-channel Digital Storage Oscilloscope (DSO) models.
- 2+16-channel and 4+16-channel Mixed Signal Oscilloscope (MSO) models.
- Color XGA display on 6000A Series models.
- 6000L models are LXI class C compliant, in a 1 unit high package.
- An MSO lets you debug your mixed-signal designs using up to four analog signals *and* 16 tightly correlated digital signals simultaneously.
- You can easily upgrade a 6000A or 6000L Series oscilloscope from a DSO to an MSO.
- You can easily increase memory depth of a 6000A Series oscilloscope that has less than 8 Mpts of memory. All InfiniiVision 6000 Series oscilloscopes purchased after March 1, 2008 are shipped with the maximum (8 Mpts) memory depth. Maximum memory depth is standard in all 6000L Series oscilloscopes.
- You can easily add options listed in Table 4 on page 7.

The InfiniiVision 6000 Series oscilloscopes feature MegaZoom III technology:

- Most responsive deep memory.
- Highest definition color display (6000A models).
- Fastest waveform update rates, uncompromised.

For more information about Agilent InfiniiVision 6000 Series oscilloscopes, see www.agilent.com/find/6000.

Table 1 Model Numbers, Bandwidths, and Sampling Rates

Bandwidth	100 MHz	300 MHz	500 MHz	1 GHz
Maximum Sample Rate	2 GSa/s	2 GSa/s	4 GSa/s	4 GSa/s
2-Channel + 16 Logic Channels MSO	MSO6012A	MSO6032A	MSO6052A	MSO6102A
4-Channel + 16 Logic Channels MSO	MSO6014A	MSO6034A	MSO6054A	MSO6104A
2-Channel DSO	DSO6012A	DSO6032A	DSO6052A	DSO6102A
4-Channel DSO	DSO6014A, DSO6014L	DSO6034A	DSO6054A, DSO6054L	DSO6104A, DSO6104L

Table 2 Secure Environment Mode Option

Oscilloscope History	Action
New order. No history.	Order Option SEC. The Secure option will be installed at the factory.
Previously purchased, no confidential trace or user data has been stored.	Order N5427A. Return unit to Service Center for Secure option installation.
Previously purchased, confidential trace or user data has been stored.	Order N5427A. Replace acquisition board. Destroy old acquisition board. Return unit to Service Center for Secure option installation.

Memory upgrades can be easily installed without returning the oscilloscope to a Service Center. These upgrades are licensed. All InfiniiVision 6000 Series oscilloscopes purchased after March 1, 2008 are shipped with the maximum (8 Mpts) memory depth.

Table 3 Memory Depth Options for pre-March 1, 2008 oscilloscopes

Maximum Memory Depth	8 Mpts
MSO/DSO6012A, MSO/DSO6014A, MSO/DSO6032A, MSO/DSO6034A oscilloscopes	8ML at time of purchase, or N2911A after purchase
MSO/DSO6052A, MSO/DSO6054A, MSO/DSO6102A, MSO/DSO6104A oscilloscopes	8MH at time of purchase, or N2913A after purchase

The following options can be easily installed without returning the oscilloscope to a Service Center. These upgrades are licensed.

Table 4 Upgrade Options

Licensed Option	Order
Mixed Signal Oscilloscope (MSO)	Order N2735, N2736A, or N2737A (see data sheet). You can easily install this option yourself. The logic cable kit is supplied with the MSO license.
Segmented Memory	Order N5454A after purchase (Option SGM at time of purchase). You can easily install this option yourself.
Mask Limit Test	Order N5455A after purchase (Option LMT at time of purchase). You can easily install this option yourself.
Measurement Statistics & Tracking Cursors	Order N5466A after purchase. You can easily install this option yourself.
I2C/SPI serial decode option (for 4 channel or 4+16 channel models only)	Order N5423A after purchase (Option LSS at time of purchase). You can easily install this option yourself.
CAN/LIN automotive triggering and decode (for 4 channel or 4+16 channel models only)	Order N5424A after purchase (Option AMS at time of purchase). You can easily install this option yourself.
FlexRay trigger and decode (for MSO 4 channel or 4+16 channel models only)	Order N5432A FlexRay triggering and decode option.
N5406A FPGA dynamic probe for Xilinx (MSO recommended)	N5406A with Option 001 (Oscilloscope-locked license) or Option 002 (PC-locked license). Software is installed on an external PC.
N5434A FPGA dynamic probe for Altera (MSO recommended)	N5434A with Option 001 (Oscilloscope-locked license) or Option 002 (PC-locked license). Software is installed on an external PC.

The following option cannot be installed after time of purchase.

Table 5 Order-Only Options

Licensed Option	Order
Battery Operation (Option BAT)	Available at time of purchase. Option can not be added after purchase.

Visit www.agilent.com/find/6000 to view the 6000A Series and 6000L Series data sheets.

Built-in Quick Help

A Quick Help system is built into the oscilloscope. Instructions for using the quick help system are given on [page 63](#).

Digital Channels

Because all of the oscilloscopes in the Agilent 6000 Series have analog channels, the analog channel topics in this book apply to all instruments. Whenever a topic discusses the digital channels, that information applies only to Mixed-Signal Oscilloscope (MSO) models or DSO models that have been upgraded to an MSO.

Using this book with the 6000L Series oscilloscopes

The 6000L Series oscilloscopes do not have a built-in display or front panel control keys. If you are using a 6000L Series oscilloscope, and this book refers to using front panel controls, you can use the built-in Web control feature described on [page 49](#) to complete the instructions.

Abbreviated instructions for pressing a series of keys



Instructions for pressing a series of keys are written in an abbreviated manner. Instructions for pressing Key1, then pressing Key2, then pressing Key3 are abbreviated as follows:

Press **Key1 & Key2 & Key3**.



The keys may be front panel keys, or softkeys. **Softkeys** are the six keys that are located directly below the oscilloscope display.

Contents

1	Getting Started	23
	To inspect package contents	25
	To install the optional front panel overlay	31
	To adjust the 6000A Series handle	32
	To mount the oscilloscope in a rack	33
	To mount the 6000A Series oscilloscope in a rack	33
	To mount the 6000L Series oscilloscope in a rack	33
	6000L Mounting Bracket Dimensions	36
	Ventilation requirements	37
	To power-on the oscilloscope	38
	AC-Powered 6000 Series	38
	Battery-Powered 6000A Series	38
	 Maintain oscilloscope ground connection on Option BAT oscilloscopes	39
	The remote interface	42
	To establish a LAN connection (6000A Series)	43
	To establish a LAN connection (6000L Series)	45
	To establish a point-to-point LAN connection	47
	To use the Web interface	48
	Controlling the oscilloscope using a Web browser	49
	Setting a password	51
	Scrolling and Monitor Resolution	54
	Identify Function	54
	Printing the oscilloscope's display from a web browser	55

- To connect the oscilloscope probes 56
-  Maximum input voltage in 50 Ω mode 56
-  Maximum input voltage for analog inputs 57
- To verify basic oscilloscope operation 57
- To compensate the oscilloscope probes 59
- To calibrate the probes 60
- Passive Probes Supported 60
- Active Probes Supported 61
 - By 300 MHz, 500 MHz, and 1 GHz Bandwidth Models 61
 - By 100 MHz Bandwidth Models 62
- Using Quick Help 63
 - Quick Help Languages 64
 - Graphical User Interface Languages 64
 - Quick Help Updates 64
- 2 Front-Panel Controls 65**
 - 6000L Series Oscilloscope Controls 66
 - Front and Rear Panel Controls and Connectors 67
 - 6000A Series Oscilloscope Front-Panel Controls 70
 - Conventions 71
 - Graphic Symbols in Softkey Menus 71
 - 4-Channel 6000A Series Oscilloscope Front Panel 72
 - Front Panel Controls 73
 - 2-Channel 6000A Series Oscilloscope Front Panel (differences only) 79
 -  Maintain oscilloscope ground connection on Option BAT oscillo-

scopes	81
Interpreting the display	82
6000A Series Front-Panel Operation	83
To adjust the waveform intensity	83
To adjust the display grid (graticule) intensity	83
To start and stop an acquisition	84
To make a single acquisition	85
To pan and zoom	86
Choosing Auto trigger mode or Normal trigger mode	87
Using AutoScale	87
To set the probe attenuation factor	88
Using the analog channels	90
To set up the Horizontal time base	95
To make cursor measurements	102
To make automatic measurements	103
Using Labels	105
To print the display	109
To set the clock	110
To set up the screen saver	111
To set the waveform expansion reference point	112
To perform service functions	113
User Calibration	113
Self Test	116
About Oscilloscope	116
To restore the oscilloscope to its default configuration	118
3 Viewing and Measuring Digital Signals	119
To connect the digital probes to the circuit under test	120
 Use only Agilent digital probe cable	120
Acquiring waveforms using the digital channels	123

To display digital channels using AutoScale	124
Example	124
Interpreting the digital waveform display	126
To switch all digital channels on or off	127
To switch groups of channels on or off	127
To switch a single channel on or off	127
To change the displayed size of the digital channels	128
To reposition a digital channel	128
To change the logic threshold for digital channels	129
To display digital channels as a bus	130
4 Triggering the Oscilloscope	135
Selecting Trigger Modes and Conditions	138
To select the Mode and Coupling menu	138
Trigger modes: Normal and Auto	139
To select trigger Coupling	141
To select trigger Noise Rejection and HF rejection	141
To set Holdoff	142
The External Trigger input	144
2-Channel oscilloscope External Trigger input	144
 Maximum input voltage for external trigger (2-channel oscilloscopes)	145
4-Channel oscilloscope External Trigger input	146
 Maximum input voltage for external trigger (4-channel oscilloscopes)	146
Trigger Types	147

To use Edge triggering	148
Trigger level adjustment	149
To use Pulse Width triggering	150
< qualifier time set softkey	152
> qualifier time set softkey	152
To use Pattern triggering	153
Hex Bus Pattern Triggering	155
To use CAN triggering	156
To use Duration triggering	161
< qualifier time set softkey	163
> qualifier time set softkey	163
To use FlexRay triggering	164
Triggering on FlexRay Frames, Times, or Errors	164
To use I2C triggering	169
To use Nth Edge Burst triggering	175
To use LIN triggering	177
To use Sequence triggering	181
Define the Find: stage	183
Define the Trigger on: stage	184
Define the optional Reset on: stage	186
Adjust the trigger level	187
To use SPI triggering	188
Assign source channels to the clock, data, and frame signals	190
Set up the number of bits in the serial data string and set values for those data bits	193
Resetting all bits in the serial data string to one value	193

- To use TV triggering 193
 - Example exercises 197
 - To trigger on a specific line of video 197
 - To trigger on all sync pulses 199
 - To trigger on a specific field of the video signal 200
 - To trigger on all fields of the video signal 201
 - To trigger on odd or even fields 202
- To use UART/RS232 triggering 205
- To use USB triggering 210
- The Trigger Out connector 212
 - Triggers 212
 - Source frequency 212
 - Source frequency/8 212
- 5 Making Measurements 213**
 - To use the XY horizontal mode 214
 - Math Functions 219
 - To use waveform math 219
 - To perform a math function upon an arithmetic operation 220
 - Math scale and offset 220
 - Units 221
 - Multiply 221
 - Add or Subtract 223
 - Differentiate 225
 - Integrate 227
 - FFT Measurement 229
 - FFT Operation 231
 - Square Root 236
 - Cursor Measurements 238
 - To make cursor measurements 238
 - Cursor Examples 243

Automatic Measurements	246
To make an automatic measurement	247
Measurement Statistics	249
To set measurement thresholds	252
Measurement Definitions	254
Time Measurements	254
Delay and Phase Measurements	258
Voltage Measurements	260
Overshoot and Preshoot Measurements	266
6 Displaying Data	269
Pan and Zoom	270
To pan and zoom a waveform	271
To set the waveform expansion reference point	271
Antialiasing	272
Using the XGA video output	272
Display Settings	273
Infinite persistence	273
Grid intensity	274
Vectors (connect the dots)	274
Varying the intensity to view signal detail	275
Acquisition Modes	277
At Slower Sweep Speeds	277
Selecting the Acquisition mode	277
Normal Mode	278
Peak Detect Mode	278
High Resolution Mode	278
Averaging Mode	279
Realtime Sampling Option	281

Segmented Memory	283
Using segmented memory	283
Using Mask Test	287
To create a mask from a “golden” waveform	287
Setup Options	289
Statistics	292
To manually modify a mask file	293
Building A Mask File	297
Using Serial Decode	301
To decode I ² C data	302
To decode SPI data	306
To decode CAN data	311
CAN Totalizer	317
To decode LIN data	319
To decode FlexRay	325
Modes of VPT1000 Control/Operation	325
Setting Up the Oscilloscope and the VPT1000	326
To display decoded FlexRay data	331
FlexRay Totalizer	334
To decode UART/RS232 data	336
UART/RS232 Totalizer	342
To reduce the random noise on a signal	343
HF Reject	343
LF Reject	344
Noise rejection	344
To capture glitches or narrow pulses with peak detect and infinite persistence	345
Using peak detect mode to find a glitch	346

	How AutoScale Works	348
	Undo AutoScale	348
	Specifying the Channels Displayed After AutoScale	349
	Preserving the Acquisition Mode During AutoScale	349
7	Saving and Printing Data	351
	Printing the oscilloscope's display	352
	Quick Print	352
	To print the oscilloscope's display	353
	Print options	353
	Selecting print options	354
	Palette	354
	Supported Printers	355
	Saving oscilloscope data	356
	Selecting a destination for your saved data	357
	Selecting a file name	358
	Waveform Trace and Oscilloscope Setup	360
	Display Image and Waveform Data Files	360
	Choosing save settings	362
	To save a waveform and/or setup to a USB device	366
	To save a waveform and/or setup to the oscilloscope's internal memory	368
	To recall waveform trace and/or oscilloscope setup	368
	File explorer	368
	To use the file explorer	371
	Secure Environment Mode Option	372
8	Reference	375
	Upgrading to an MSO or adding memory depth	376
	Software and firmware updates	376
	To set up the I/O port	377

Using the 10 MHz reference clock	378
Sample clock and frequency counter accuracy	378
Supplying an external timebase reference	378
To supply a sample clock to the oscilloscope	378
 Maximum input voltage for 10 MHz reference input	378
To synchronize the timebase of two or more instruments	380
To check warranty and extended services status	380
To return the instrument	381
To clean the oscilloscope	381
Digital channel signal fidelity: Probe impedance and grounding	382
Input Impedance	382
Probe Grounding	384
Best Probing Practices	386
To replace digital probe leads	387
Binary Data (.bin)	388
Binary Data in MATLAB	389
Binary Header Format	389
Example Program for Reading Binary Data	393
Examples of Binary Files	394
CSV and ASCII XY files	396
VPT1000 IP address and firmware updates	398
Changing the VPT1000 network settings	398
Updating the VPT1000 firmware	399
9 Power and Environmental Conditions	401
Power Requirements	402

Measurement Category 403
 Measurement Category 403
 Measurement Category Definitions 403
 Transient Withstand Capability 404

 Maximum input voltage for analog inputs 404

Environmental Conditions 405

Specifications 406

Acknowledgements 406

Contact us 407

Index 409

Contents

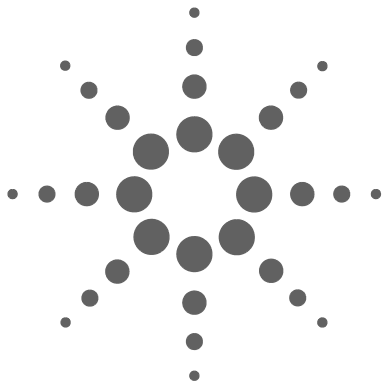

1 Getting Started

To inspect package contents	25
To adjust the 6000A Series handle	32
To mount the oscilloscope in a rack	33
To power-on the oscilloscope	38
Ventilation requirements	37
The remote interface	42
To establish a LAN connection (6000A Series)	43
To establish a LAN connection (6000L Series)	45
To establish a point-to-point LAN connection	47
To use the Web interface	48
Printing the oscilloscope's display from a web browser	55
To connect the oscilloscope probes	56
To verify basic oscilloscope operation	57
To compensate the oscilloscope probes	59
To calibrate the probes	60
Passive Probes Supported	60
Active Probes Supported	61
Using Quick Help	63

To get started using the oscilloscope:

- ✓ Unpack the oscilloscope and verify the contents.
- ✓ Adjust the 6000A Series oscilloscope's handle position.
- ✓ Apply power to the oscilloscope.
- ✓ Connect the probes to the oscilloscope.
- ✓ Verify basic oscilloscope operation and compensate the probes.



Built-in Quick Help

A Quick Help system is built into the oscilloscope. Instructions for using the quick help system are given on page 63.

Digital Channels

Because all of the oscilloscopes in the Agilent 6000 Series have analog channels, the analog channel topics in this book apply to all instruments. Whenever a topic discusses the digital channels, that information applies only to Mixed-Signal Oscilloscope (MSO) models or DSO models that have been upgraded to an MSO.

Using this book with the 6000L Series oscilloscopes

The 6000L Series oscilloscopes do not have a built-in display or front panel control keys. If you are using a 6000L Series oscilloscope, and this book refers to using front panel controls, you can use the built-in Web control feature described on page 49 to complete the instructions.

Abbreviated instructions for pressing a series of keys

Instructions for pressing a series of keys are written in an abbreviated manner. Instructions for pressing Key1, then pressing Key2, then pressing Key3 are abbreviated as follows:

Press **Key1 & Key2 & Key3**.

The keys may be front panel keys, or softkeys. **Softkeys** are the six keys that are located directly below the oscilloscope display.

To inspect package contents

- ✓ Inspect the shipping container for damage.

If your shipping container appears to be damaged, keep the shipping container or cushioning material until you have inspected the contents of the shipment for completeness and have checked the oscilloscope mechanically and electrically.

- ✓ Verify that you received the following items and any optional accessories you may have ordered:
 - InfiniiVision 6000 Series Oscilloscope
 - Front-panel cover (6000A Series only)
 - Power cord (country of origin determines specific type)
 - Models with Option BAT only: Power Supply (P/N 0950-4866)
 - LAN Crossover Cable 5061-0701 (6000L Series only)
 - GPIB cable extender P/N 5183-0803 (6000L Series only)
 - 50 ohm feedthrough termination adapter P/N 0960-0301 (Qty. 4 supplied with DSO6014L only)
 - Oscilloscope probes
 - Two probes for 2-channel models
 - Four probes for 4-channel models
 - 10074C probes for 100 MHz bandwidth models
 - 10073C probes for all other models
 - User's Guide
 - CD-ROM containing the Service Guide, Programmer's Quick Start Guide, and the Programmer's Reference Guide
 - Automation-Ready Software CD-ROM
 - MSO Models: digital probe kit (54620-68701) and digital cable guide (54684-42301)

1 Getting Started

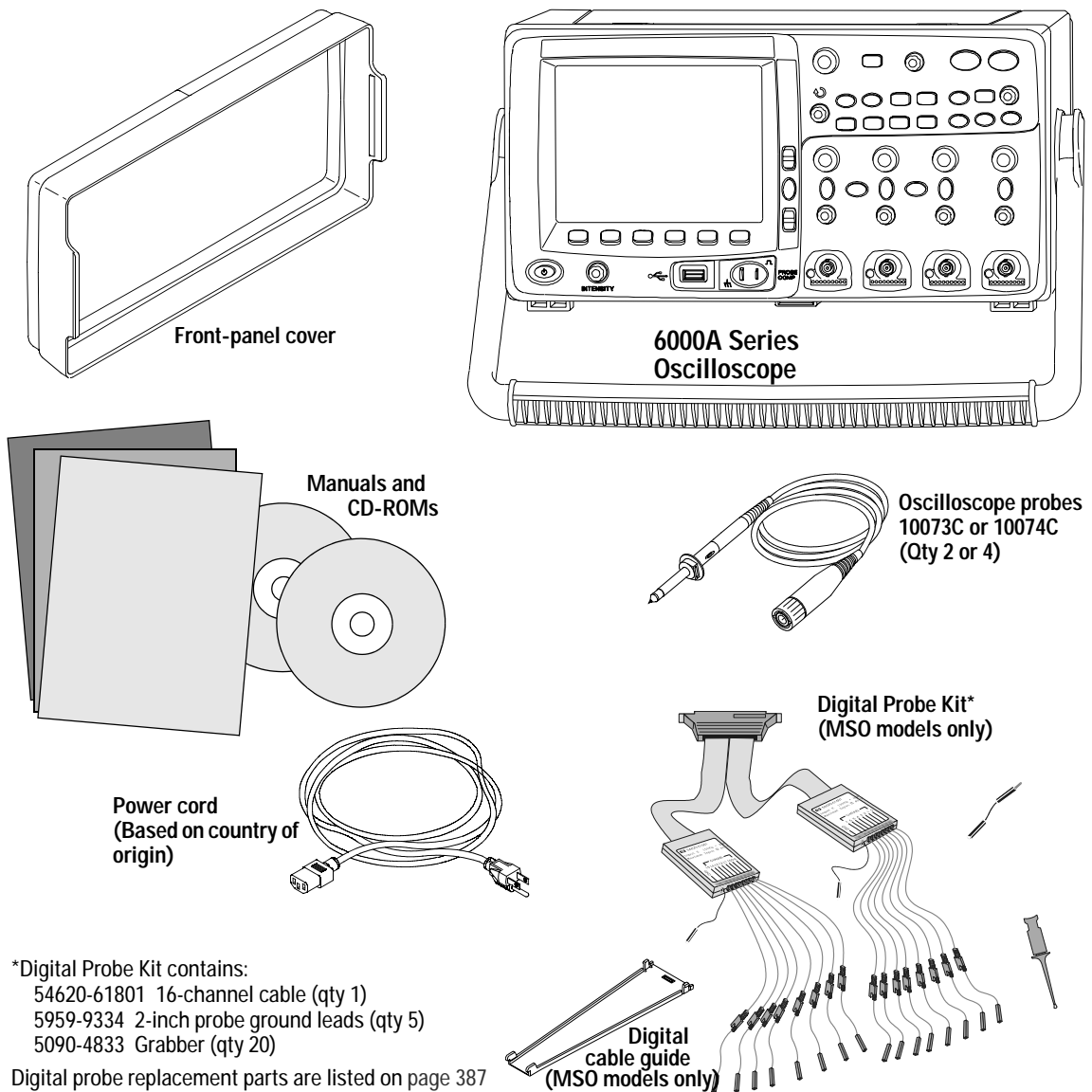

Figure 1 Package contents for 6000A Series AC-powered oscilloscopes

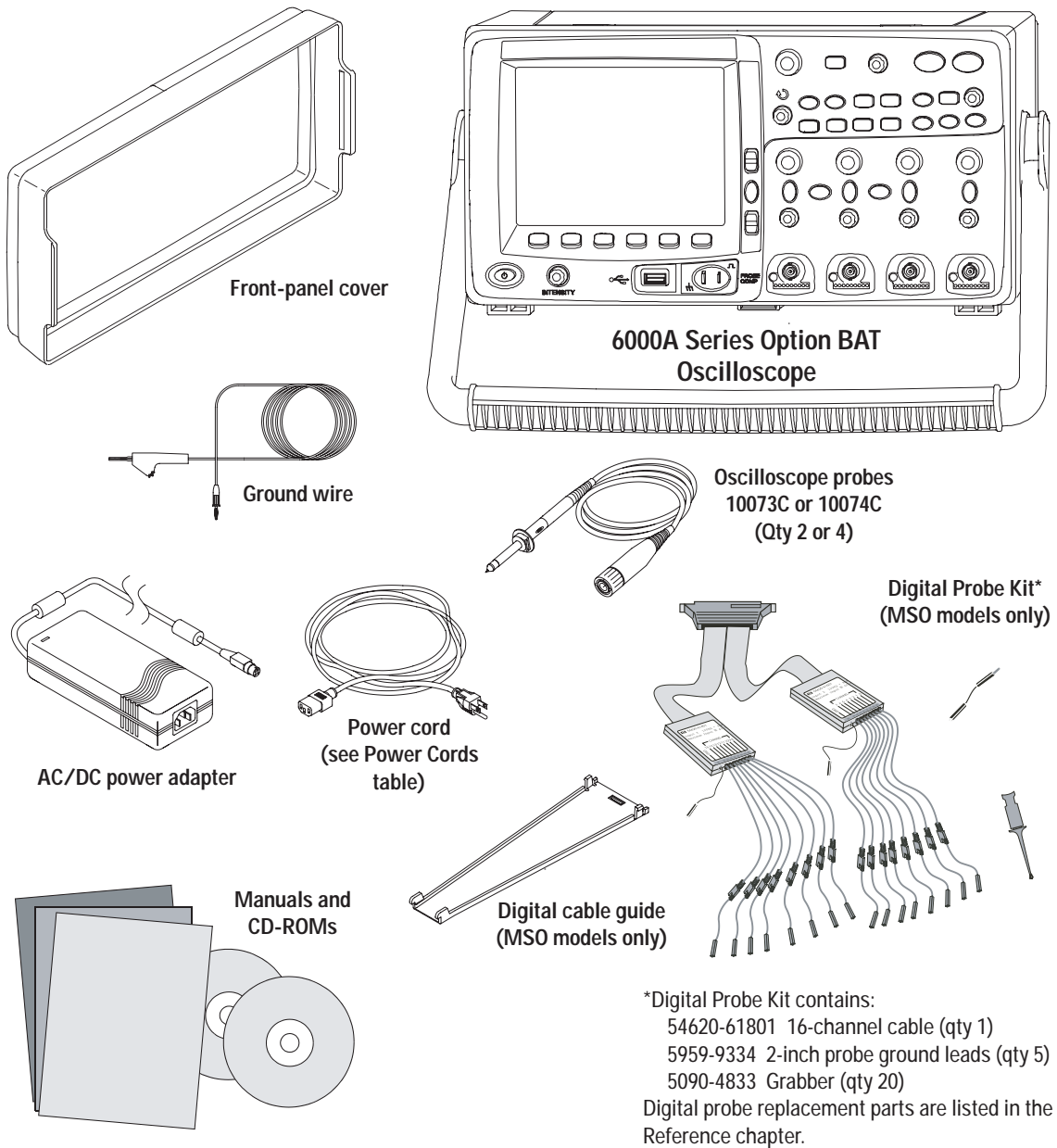
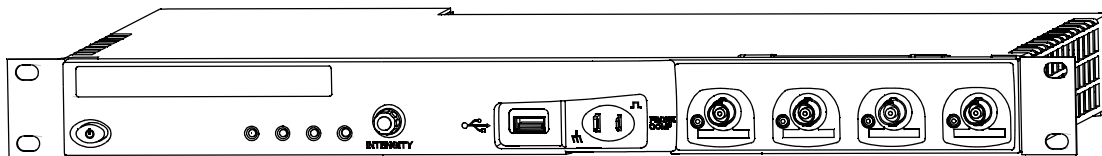

Figure 2 Package contents for 6000A Series battery-powered oscilloscopes (Option BAT)



6000L Series Oscilloscope



50 ohm feedthrough
termination adapter
P/N 0960-0301, Qty. 4

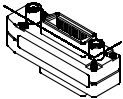

GPIB cable extender
P/N 5183-0803

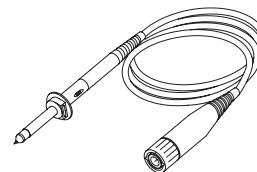

Oscilloscope Probes
10073C or 10074C
Qty. 4

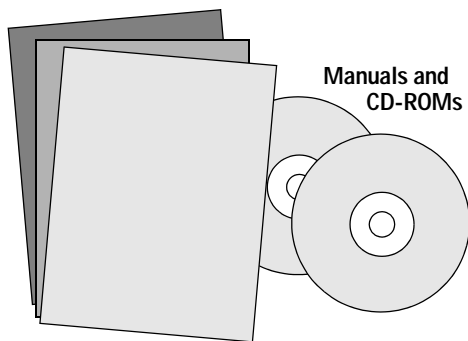

Manuals and
CD-ROMs

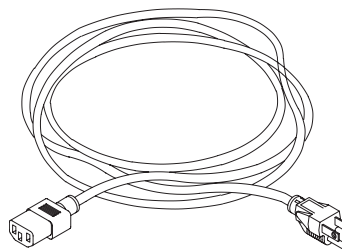

Power cord
(Based on country of
origin)

Rack Mount Kit
(not shown)

Figure 3 Package contents for 6000L Series oscilloscopes

Table 6 Accessories available

Model	Description
N2918A	6000 Series Oscilloscope Evaluation Kit
1180CZ	Testmobile oscilloscope cart (requires N2919A adapter kit)
N2919A	Testmobile Adapter Kit
N2916A	6000A Rackmount Kit
54684-44101	Front-panel cover
	Front panel overlay - see page 31.
N2605A-097	USB cable
10833A	GPIB cable, 1 m long
10073C	Passive probe, 10:1, 500 MHz, 1.5 m
10074C	Passive probe, 10:1, 100 MHz, 1.5 m
54620-68701	Digital probe kit
54684-42301	Digital probe cable guide (cable tray)
0960-0301	50-Ohm Feedthrough
01650-61607	16:16 logic cable and terminator (use with header on target sys.)
54620-68701	16:2 x 8 logic input probe assembly (standard with MSO models)
10070C	Passive probe, 1:1 20 MHz, 1.5 m
10074C	Passive probe, 10:1, 150 MHz, 1.5 m
10073C	Passive probe, 10:1, 500 MHz, 1.5 m
1165A	Passive probe, 10:1, 600 MHz, 1.5 m
10076A	Passive probe, 100:1, 4 kV, 250 MHz
N2771A	Passive probe, 1000:1, 30 kV, 50 MHz
1156A	Active probe, 1.5 GHz AutoProbe interface
1144A	Active probe, 800 MHz (requires 1142A – power supply)
1145A [†]	Active probe, 750 MHz 2-ch (requires 1142A – power supply)
1130A [†]	For active differential probes: 1.5 GHz InfiniiMax amplifier with AutoProbe interface (requires one or more InfiniiMax probe head – E2675A, E2668A, E2669A).
N2772A	Active differential probe, 20 MHz, 1.2 kVDC + peak AC max (requires N2773A power supply)
1141A	Active differential probe, 200 MHz, 200 VDC + peak AC max (requires 1142A power supply)
1146A	Current probe, 100 kHz, 100 A, AC/DC
1147A [†]	Current probe, 50 MHz, 30 A, AC/DC with AutoProbe interface
N2780A	Current probe, 2 MHz, 500 A, AC/DC (use with N2779A power supply)
N2781A	Current probe, 10 MHz, 150 A, AC/DC (use with N2779A power supply)

Model	Description
N2782A	Current probe, 50 MHz, 30 A, AC/DC (use with N2779A power supply)
N2783A	Current probe, 100 MHz, 30 A, AC/DC (use with N2779A power supply)
10072A	Fine-pitch probe kit
10075A	0.5 mm IC clip kit
10076A	100:1, 4 kV 250 MHz probe
E2613B	0.5 mm Wedge probe adapter, 3-signal, qty 2
E2614A	0.5 mm Wedge probe adapter, 8-signal, qty 1
E2615B	0.65 mm Wedge probe adapter, 3-signal, qty 2
E2616A	0.65 mm Wedge probe adapter, 8-signal, qty 1
E2643A	0.5 mm Wedge probe adapter, 16-signal, qty 1
E2644A	0.65 mm Wedge probe adapter, 16-signal, qty 1

[†]Indicates a maximum of two of this model probe can be connected to each oscilloscope due to AutoProbe interface current supply limitation. See also “Passive Probes Supported” on page 60 and “Active Probes Supported” on page 61.

You can find these items at www.agilent.com or at www.parts.agilent.com.

For information on more probes and accessories see “5989-6162EN Probes and Accessories Selection Guide” and “5968-8153EN 5000 and 6000 Series Oscilloscope Probes and Accessories data sheet, available at www.agilent.com.

To install the optional front panel overlay

Availability of front panel overlays in Simplified Chinese, Traditional Chinese, and Japanese is planned for September 2008. The appropriate overlay will be included when the Chinese or Japanese user's guide is chosen at time of purchase.

Large label: Remove the protective backing to expose the adhesive, align the label with the top and left edge of the front panel, and press the overlay into place.

Small Label: Remove the protective backing, and affix over existing label. Note: the cut-outs at the top of the label are for indicators on battery operated units.

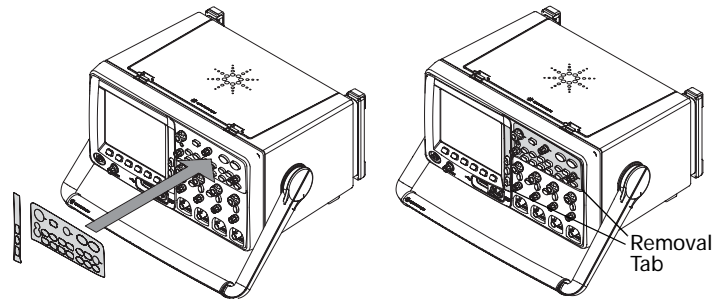

To remove the label, carefully pull it away using the tab at the lower right corner.

The overlays will be available at www.parts.agilent.com using the following part numbers:

Part number	Description
54684-94316	Overlay - Simplified Chinese
54684-94317	Overlay - Traditional Chinese
54684-94318	Overlay - Japanese

To adjust the 6000A Series handle

You can use the oscilloscope's handle for carrying the instrument, or you can use it as a stand to tilt the instrument up for easier viewing of its display.

- 1 Grasp the handle hubs on each side of the instrument and pull the hubs out until they stop.

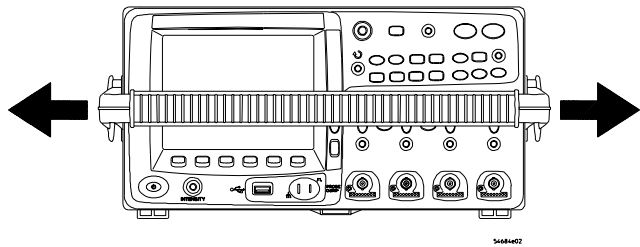

- 2 Without releasing the hubs, rotate the handle to the desired position. Then release the hubs. Continue rotating the handle until it clicks into a set position.

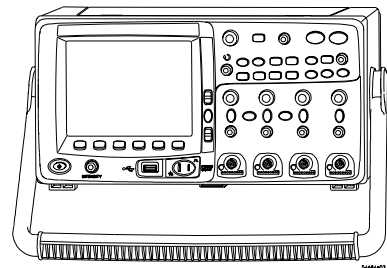
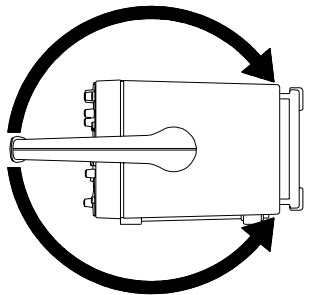

To mount the oscilloscope in a rack

The InfiniiVision 6000 Series oscilloscopes can be mounted into Electronic Industries Association (EIA) standard 19-inch (487-mm) rack cabinets.

To mount the 6000A Series oscilloscope in a rack

Purchase and install the N2916A rack mount kit. Instructions are included in the kit.

To mount the 6000L Series oscilloscope in a rack

The 6000L Series oscilloscope is supplied with all necessary hardware for installation into a standard EIA 19-inch rack.

Table 7 Rack Mount Hardware Supplied

Quantity	Description	Agilent Part Number
2	Front Extender Support	D6104-01201
2	Rear Extender Support	D6104-01202
4	Rear Extender Screw (M3 x 6 mm)	0515-0430
4	Dress Screw (10-32 x 0.0625)	0570-1577
8	Rail Screw (10-32 x 0.375)	2680-0281
12	Clip-nut (10-32)	0590-0804

Tools required (not supplied)

- #2 Phillips screwdriver
- T20 Torx driver
- T10 Torx driver

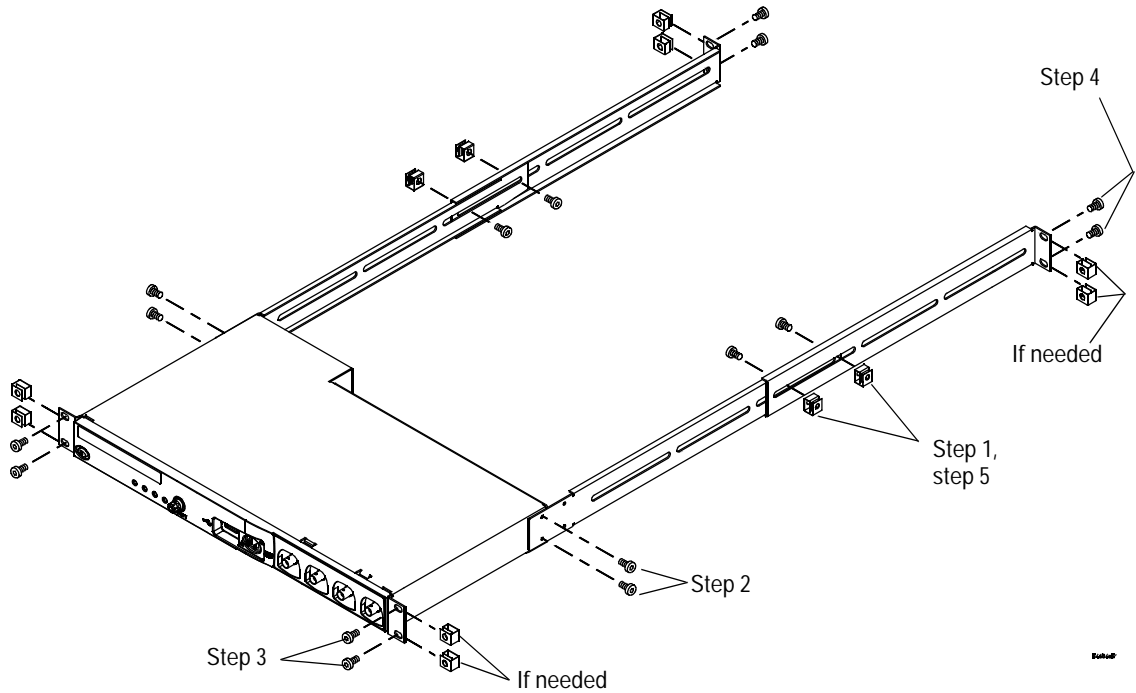

- 1 Loosely attach the Front Extender Supports to the Rear Extender Supports with four (4) clip-nuts and four (4) of the 10-32 x 0.375 Rail Screws. (The screws require a Torx T20 driver.) Choose the correct set of slots in the supports such that their overall length is approximately correct for the depth of your cabinet.

- 2 Fasten the Rack Mount Extenders to the oscilloscope chassis with the four (4) M3 x 6 mm screws, using a Torx T10 driver as follows:

NOTE

The sets of holes in the Rack Mount Extenders are slightly offset. This was done to ensure that the Rack Mount Extenders are attached to the oscilloscope at the correct points so that the oscilloscope's ventilation area is not obscured. The holes in the Rack Mount Extenders will align with the correct holes in the oscilloscope and the screws will go in easily. Do not force the screws into the wrong holes.

- a Attach a Rack Mount Extender to the left side of the oscilloscope using two (2) of the M3 x 6 mm screws in the *inner* set of holes on the Rack Mount Extender.

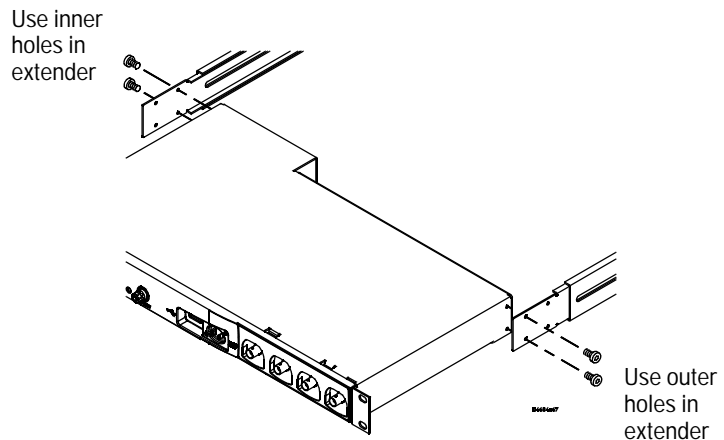

- b Attach the other Rack Mount Extender to the right side of the oscilloscope using two (2) of the M3 x 6 mm screws in the *outer* set of holes on the rack mount extender.
- 3 Place the instrument in the rack. Install the four (4) 10-32 x 0.625 Dress Screws in the chassis front ears to secure the front of the instrument to the rack. Use the Phillips screwdriver.
- 4 Align the ears in the Rear Mount Extenders with the correct set of holes in the rear of the rack and secure the Rack Mount

1 Getting Started

Extenders to the rack using the four (4) remaining 10-32 x 0.375 Rail Screws. Use the Torx T20 driver.

- 5 Securely attach the Rear Extender Supports to the Front Extender Supports by tightening the four (4) 10-32 x 0.375 Rail Screws screws that you loosely attached in step 1.

6000L Mounting Bracket Dimensions

The following information is provided in case you want to design custom mounting brackets for the 6000L. Dimensions are in mm.

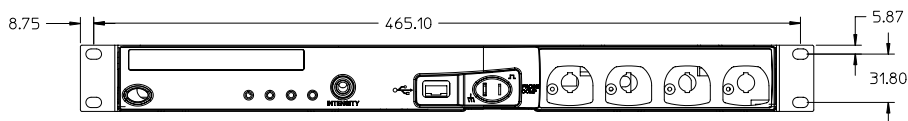
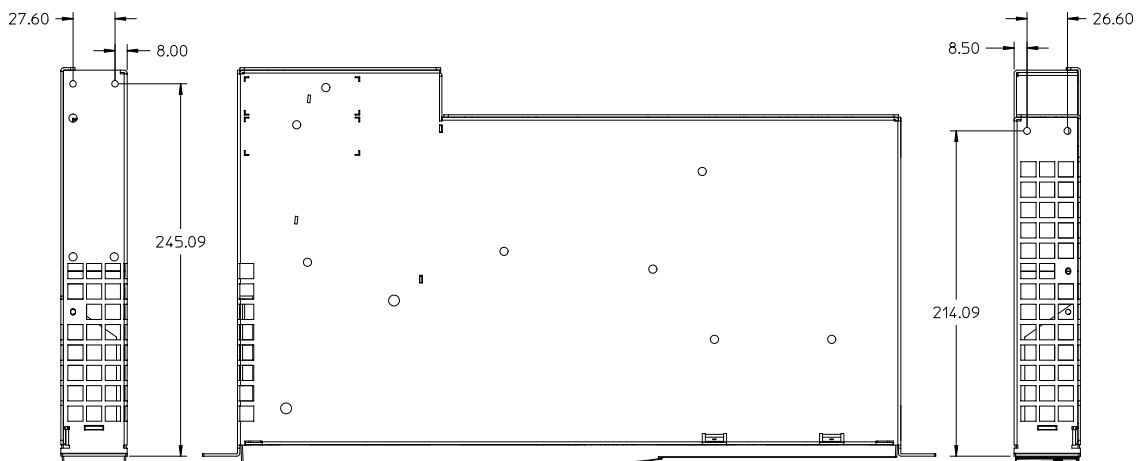

Ventilation requirements

The air intake and exhaust areas must be free from obstructions. Unrestricted air flow is required for proper cooling.

6000A Ventilation Requirements

The fan draws air in from underneath the oscilloscope and pushes it out behind the oscilloscope. Always ensure that the air intake and exhaust areas are free from obstructions.

When using the oscilloscope in a bench-top setting, provide at least 4" (100 mm) clearance behind and above the oscilloscope for proper cooling.

6000L Ventilation Requirements

The fan draws air from the left and pushes it to the right. Ensure that air flow is not obstructed.

To power-on the oscilloscope

AC-Powered 6000 Series

- 1 Connect the power cord to the rear of the oscilloscope, then to a suitable AC voltage source.

The oscilloscope automatically adjusts for input line voltages in the range 100 to 240 VAC. Ensure that you have the correct line cord. The line cord provided is matched to the country of origin.

WARNING

Always use a grounded power cord. Do not defeat the power cord ground.

- 2 Press the power switch.

The power switch is located on the lower left corner of the front panel. Some front panel lights will come on and the oscilloscope will be operational in a few seconds.

Battery-Powered 6000A Series

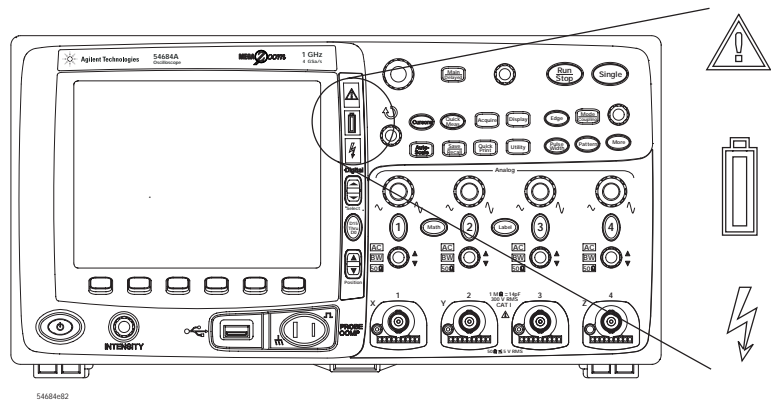

Figure 4 Additional indicators on battery-powered 6000A Series

The 6000A Series Option BAT oscilloscopes are battery powered. They have additional LED indicators on the front panel:



Caution indicator. Lights (amber) when running on the internal battery. See “Operating with the Internal Battery” below.



Battery power indicator. Turns from green to red when there is 15 to 20 minutes of battery power remaining.



Charging indicator. Lights when the battery is charging. Turns off when the battery is fully charged or when the charger is disconnected.

Battery life is approximately 1.75 hours, depending on the oscilloscope configuration.

Operating with the Internal Battery

When operating with the internal battery, the operating temperature should be in the range from -10°C to 50°C, ≤ 80% relative humidity.

- 1 Make sure battery is charged before use. See “Charging the Battery” below.
- 2 Connect the supplied ground wire from the ground post on the back of the instrument to earth ground.

WARNING



Maintain oscilloscope ground connection on Option BAT oscilloscopes

Do not negate the protective action of the ground connection to the oscilloscope. If the circuit under test has voltages greater than 30 Vrms, the oscilloscope must be grounded through its ground terminal to prevent electric shock to the user.

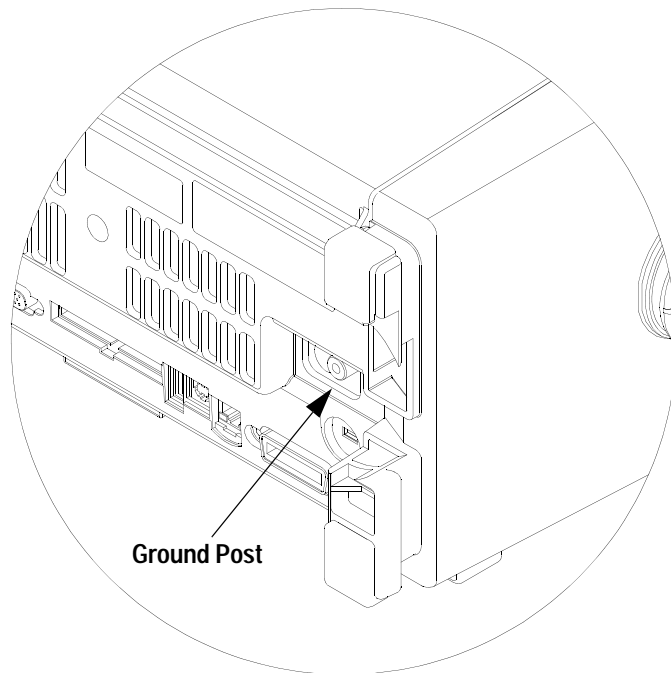

Figure 5 Ground post on rear panel

3 Press the power switch.

The power switch is located on the lower left corner of the front panel. Some front panel lights will come on and the oscilloscope will be operational in a few seconds.

Charging the Battery

When charging the battery, the operating temperature should be in the range from 0°C to 45°C, ≤ 80% relative humidity.

- 1 Connect the supplied AC adapter to the back of the oscilloscope, and connect the adapter's power cord to a suitable AC voltage source.

CAUTION

Use only the supplied AC adapter. Damage to the equipment could result if an improper AC adapter is used.

You can use the oscilloscope while the battery is being charged.

NOTE

If the battery charging indicator does not light

If the batteries are discharged enough, there may not be enough charge for internal circuitry to cause the battery charging indicator LED to light. In this case, it can take up to about 20 minutes of charging before the indicator will light.

Operating with the Automotive Power Adapter Cable

The N5429A 12V DC automotive adapter cable is for charging and operating 6000A Series Option BAT battery-powered oscilloscopes.

- 1 Connect the N5429A adapter cable to the back of the oscilloscope, and connect the other end of the cable to a 12V DC automotive power source.

Replacing the Battery

The oscilloscope battery is not user replaceable. You must return the oscilloscope to Agilent for battery replacement. Contact Agilent for further instructions (see www.agilent.com/find/contactus).

The remote interface

You can communicate with all InfiniiVision 6000 Series oscilloscopes via LAN, USB, or GPIB. 6000A Series oscilloscopes can also be controlled using the front panel keys. The 6000L Series oscilloscopes do not have a keyboard or display, so communication must be established via LAN, USB, or GPIB.

The *Automation Ready CD-ROM* provided with the oscilloscope contains connectivity software to enable communication over these interfaces. Refer to the instructions provided on the CD-ROM to install this software on your PC.

Remote commands can be issued via LAN, USB, or GPIB. These commands are generally used when the oscilloscope is under program control for automated test and data acquisition. Information about controlling the oscilloscope through remote commands is contained in the *Programmer's Quick Start Guide*, which is included in the documentation CD-ROM supplied with this oscilloscope. You can also access this document online: direct your web browser to www.agilent.com/find/6000 and select Technical Support, then select Manuals.

All 6000 Series oscilloscopes feature a built-in Web server (requires software version 4.0 or greater; see page 376 for software updating instructions). Using the Web browser you can set up measurements, monitor waveforms, capture screen images and operate the oscilloscope remotely.

Detailed Connectivity Information

For detailed connectivity information, refer to the *Agilent Technologies USB/LAN/GPIB Interfaces Connectivity Guide*. For a printable electronic copy of the Connectivity Guide, direct your Web browser to www.agilent.com and search for Connectivity Guide.

To establish a LAN connection (6000A Series)

To connect to the network using DHCP or AutoIP

- 1 Connect the oscilloscope to the local area network (LAN) by inserting the LAN cable into the “LAN” port on the rear panel of the oscilloscope. In a few moments the oscilloscope will connect to the network automatically.
 - a If the oscilloscope does not automatically connect to the network, press **Utility**→**I/O**→**LAN Reset**. In a few moments the oscilloscope will connect to the network.
 - b If desired you can enable NetBIOS. Press **Utility**→**I/O**→**Control** to access the option.
 - c When using DHCP you can select DynamicDNS if desired. Press **Utility**→**I/O**→**Control** to access the option.

To connect to the network using Manual mode

- 1 Get the oscilloscope’s network parameters (hostname, domain, IP address, subnet mask, gateway IP, DNS IP, etc.) from your network administrator.
- 2 Connect the oscilloscope to the local area network (LAN) by inserting the LAN cable into the “LAN” port on the rear panel of the oscilloscope.
- 3 On the oscilloscope, ensure the controller interface is enabled:
 - a Press **Utility**→**I/O**→**Control**.
 - b Ensure that LAN is selected. If not, use the Entry knob to point to “LAN” and then push the Entry knob.
- 4 Configure the oscilloscope’s LAN interface:
 - a Press the **LAN Settings** softkey.
 - b Press the **Config** softkey to deselect DHCP and AutoIP.
 - c Press the **Addresses** softkey.
 - d Use the **Modify** softkey (and the other softkeys and the Entry knob) to enter the IP Address, Subnet Mask,

Gateway IP, and DNS IP values. When you are done, press the return (up arrow) softkey.

- e Press the **Domain** softkey. Use the **Modify** softkey (and the other softkeys and the Entry knob) to enter the Host name and the Domain name. When you are done, press the return (up arrow) softkey.
- f Press the **Apply** softkey.

NOTE

When you connect the oscilloscope to a LAN it is a good practice to limit access to the oscilloscope by setting a password. By default, the oscilloscope is not password protected. See page 51 to set a password.

To establish a LAN connection (6000L Series)

- 1 Connect a cable from your site Local Area Network (LAN) to the LAN port on the rear panel of the oscilloscope.
- 2 Switch on the oscilloscope power. When the LAN indicator illuminates green, the LAN is connected as configured. This may take a few minutes. The oscilloscope will attempt to connect to the LAN using DHCP, AutoIP, then Manual, in that order (when enabled). These connection methods can be enabled or disabled later using the Configure Network tab in the web interface.
- 3 Open a web browser and enter the oscilloscope's hostname in the address field. The oscilloscope's Web page will be displayed.

Hostname

If you do not know the oscilloscope's hostname you can reset the hostname as follows:

- 1 Press and release the **Reset** button (see page 66, 67) on the front panel of the 6000L Series oscilloscope. This will reset the hostname to that which is printed on the label near the oscilloscope's power cord connection. The following LAN parameters will be reset:
 - Hostname
 - IP address
 - Domain name
 - VISA address
 - Password (see page 51.)

NOTE

When you connect the oscilloscope to a LAN it is a good practice to limit access to the oscilloscope by setting a password. By default, the oscilloscope is not password protected. See page 51 to set a password.

NOTE

Any time you modify the oscilloscope's hostname it will break the connection between the oscilloscope and the LAN. You will need to re-establish communication to the oscilloscope using the new hostname.

For more information about connecting to the oscilloscope, refer to the *Agilent Technologies USB/LAN/GPIB Interfaces Connectivity Guide*. For a printable electronic copy of the Connectivity Guide, direct your Web browser to www.agilent.com and search for Connectivity Guide.

To establish a point-to-point LAN connection

Stand-alone connection to a PC

The following procedure describes how to establish a point-to-point (stand alone) connection to the oscilloscope. This is useful if you want to control the oscilloscope using a laptop computer or a stand-alone computer.

- 1 Install Agilent I/O Libraries Suite from the CD that was supplied with the oscilloscope. If you do not have the CD you can download the I/O Libraries Suite from www.agilent.com/find/iolib.
- 2 Connect your PC to the oscilloscope using a cross-over LAN cable. (The 5061-0701 LAN crossover cable is supplied with 6000L Series oscilloscopes.)
- 3 Switch on the oscilloscope power. Wait until the LAN connection is configured:
 - On 6000A Series oscilloscopes, press **Utility & I/O** and wait until the LAN status shows “configured”.
 - On 6000L Series oscilloscopes, the LAN indicator illuminates green when the LAN connection is configured.

This may take a few minutes.

- 4 Start the Agilent Connection Expert application from the Agilent I/O Libraries Suite program group.
- 5 When the Agilent Connection Expert application is displayed, select **Refresh All**.
- 6 Right Click **LAN** and select **Add Instrument**.
- 7 In the Add Instrument window, the LAN line should be highlighted; select **OK**.
- 8 In the LAN Instrument window, select **Find Instruments...**
- 9 In the Search for instruments on the LAN window, **LAN** and **Look up hostnames** should be checked.
- 10 Select the **Find Now** key. (NOTE: It may take up to three minutes before the instrument is found. If the instrument is not found the first time, wait about one minute and try again.)

11 When the instrument is found, select **OK** and **OK** to close the Add Instrument windows.

Now the instrument is connected and the instrument's Web interface may be used.

To use the Web interface

All InfiniiVision 6000 Series oscilloscopes include a built-in Web server (requires software version 4.0 and above). See page 376 for information about updating your oscilloscope's software.

When you connect to the oscilloscope using a computer and web browser, you can:

- Control the oscilloscope using the Remote Front Panel function.
- Activate the Identify function (see page 54) to identify a particular instrument by causing its front panel light to blink.
- View information about the oscilloscope like its model number, serial number, host name, IP address, and VISA (address) connect string.
- View oscilloscope firmware version information and upload new firmware into the oscilloscope.
- View and modify the oscilloscope's network configuration and status information.

possible to use a point-to-point connection (see page 47), but using a LAN is the preferred method.

- 2 Type the oscilloscope's hostname or IP address in the web browser.
- 3 When the oscilloscope's Web page is displayed, select **Browser Web Control**, then select **Remote Front Panel**. After a few seconds the Remote Front Panel appears.

NOTE

If Java is not installed on your PC, you will be prompted to install the Sun Microsystems Java Plug-in. This plug-in must be installed on the controlling PC for Remote Front Panel operation.

- 4 Use the Main Menu and the Function Keys to control the oscilloscope. This is a manual way to control an oscilloscope which is normally controlled by a remote program.

Setting a password

Whenever you connect the oscilloscope to a LAN, it is good practice to set a password to prevent unauthorized access to the oscilloscope via Web browser.

- 1 Select the Configure Network tab from the instrument's Welcome page.

Agilent Technologies Oscilloscope

Current Network Configuration

Modify Configuration ← Step 2

Parameter	Currently in use
DHCP	ON
Automatic IP	OFF
IP Address	130.29.70.119
Subnet Mask	255.255.248.0
Default Gateway	130.29.64.1
DHCP Server	130.29.64.128
DNS Server	130.29.64.128, 130.29.108.128
Hostname	a-d6104l-000005
Domain	cos.agilent.com
NetBIOS	ON
LAN KeepAlive Timeout	1800
Media Sense	ON
GPIB Address	7

Step 1 →

2 Select the Modify Configuration button.



Parameter	Configured Value	Edit Configuration
IP Settings may be obtained automatically using the following:		
DHCP	ON	<input type="radio"/> OFF <input checked="" type="radio"/> ON
Automatic IP	ON	<input type="radio"/> OFF <input checked="" type="radio"/> ON
IP Settings to use if automatic modes are off or servers are unavailable:		
IP Address	0.0.0.0	<input type="text" value="0.0.0.0"/>
Subnet Mask	0.0.0.0	<input type="text" value="0.0.0.0"/>
Default Gateway	0.0.0.0	<input type="text" value="0.0.0.0"/>
DNS Server	0.0.0.0	<input type="text" value="0.0.0.0"/>
Hostname	a-d6104l-000005	<input type="text" value="a-d6104l-000005"/>
Domain		<input type="text"/>
NetBIOS	ON	<input type="radio"/> OFF <input checked="" type="radio"/> ON
KeepAlive Timeout (sec)	1800	<input type="text" value="1800"/>
Description	Agilent DSO6104L (MY46000005)	<input type="text" value="Agilent DSO6104L (MY46000005)"/>
Password		<input type="text"/>
GPIB Address	7	<input type="text" value="7"/>

Step 3

3 Enter your desired password, and click **Apply Changes**.

4 To reset the password:

- 6000A Series oscilloscopes - Press **Utility & I/O & LAN Reset**.
- 6000L Series oscilloscopes - Press the **LAN RESET** button on the front panel.

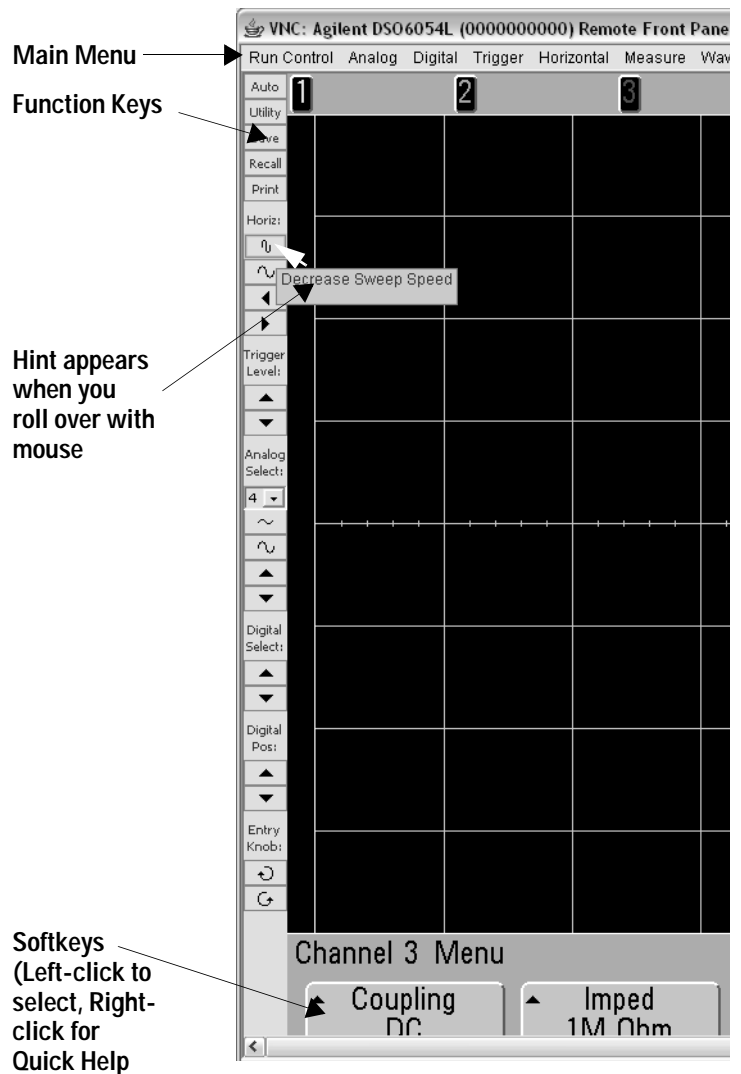

Scrolling and Monitor Resolution

When using a monitor resolution of 1024 x 768 or less on the remote computer, you need to scroll to access the full remote front panel. To display the remote front panel without scroll bars, use a monitor resolution greater than 1024 x 768 on your computer's display.

Identify Function

Select Identification **on** button on the oscilloscope's web page. On a 6000L Series oscilloscope, the LAN indicator on the front of the instrument will flash green to identify the oscilloscope until you select Identification **off**. On a 6000A Series oscilloscope, an "Identify" message is displayed; you can either select Identification **off** or press the **OK** Softkey on the oscilloscope to continue. This feature is useful when trying to locate a specific instrument in a rack of equipment.

The screenshot shows the Agilent Oscilloscope web interface. At the top, there is a navigation bar with 'Support | Products | Agilent Site' and a logo for 'Another web-enabled instrument from Agilent Technologies'. The main content area is titled 'Welcome to your Web-Enabled Oscilloscope' and features the LXI logo. Below this, there is a table titled 'Information about this Web-Enabled Instrument' with the following data:

Instrument	DSO6104L Oscilloscope
Serial Number	MY46000005
Description	Agilent DSO6104L (MY46000005)
Hostname	a-d6104l-000005.cos.agilent.com
IP Address	130.29.69.254
VISA TCP/IP Connect String	TCPIP0::a-d6104l-000005::INSTR

Below the table, there is a section for 'Advanced information' with the 'Identification' option set to 'on'. An arrow points to this option with the label 'Identification Option'. A note at the bottom of the page reads: 'Use the navigation bar on the left to access your Oscilloscope and related information.' The footer includes '© Agilent Technologies, Inc. 2006'.

Printing the oscilloscope's display from a web browser

To print the oscilloscope's display from a web browser:

- 1 Establish a connection to the oscilloscope as described in this chapter and go to the oscilloscope's Welcome page.
- 2 Select the **Get Image** tab from the left side of the Welcome screen. After a delay of several seconds, the oscilloscope's screen image will be displayed.
- 3 Right-click on the image and select "Save Picture As...".
- 4 Select a storage location for the image file and click **Save**.

For more information about connecting the oscilloscope to a LAN see the *Agilent Technologies USB/LAN/GPIB Interfaces Connectivity Guide*. For a printable electronic copy of the Connectivity Guide, direct your Web browser to www.agilent.com and search for Connectivity Guide.

To connect the oscilloscope probes

The analog input impedance of the 100 MHz oscilloscopes is fixed at 1 M Ω . The 1 M Ω mode is for use with many passive probes and for general purpose measurements. The high impedance minimizes the loading effect of the oscilloscope on the circuit under test. If a 50 Ω input impedance is required, attach a 50 ohm feedthrough termination adapter such as Agilent part number 0960-0301 to the oscilloscope's channel input BNC connector.

The analog input impedance of the 300 MHz, 500 MHz, and 1 GHz oscilloscopes can be set to either 50 Ω or 1 M Ω . The 50 Ω mode matches 50 Ω cables and some active probes commonly used in making high frequency measurements. This impedance matching gives you the most accurate measurements since reflections are minimized along the signal path.

- 1 Connect the supplied oscilloscope probe to an oscilloscope channel BNC connector on the front panel of the oscilloscope.
- 2 Connect the retractable hook tip on the probe tip to the circuit point of interest. Be sure to connect the probe ground lead to a ground point on the circuit.

CAUTION



Maximum input voltage in 50 Ω mode

Do not exceed 5 Vrms at the BNC in 50 Ω mode on the Agilent 6000 Series oscilloscopes. Input protection is enabled in 50 Ω mode and the 50 Ω load will disconnect if greater than 5 Vrms is detected. However the inputs could still be damaged, depending on the time constant of the signal. The 50 Ω input protection mode on the Agilent 6000 Series oscilloscopes only functions when the oscilloscope is powered on.

CAUTION



The probe ground lead is connected to the oscilloscope chassis and the ground wire in the power cord. If you need to measure between two live points, use a differential probe. Defeating the ground connection and "floating" the oscilloscope chassis will probably result in inaccurate measurements.

WARNING

Do not negate the protective action of the ground connection to the oscilloscope. The oscilloscope must remain grounded through its power cord. Defeating the ground creates an electric shock hazard.

CAUTION

Maximum input voltage for analog inputs

CAT I 300 Vrms, 400 Vpk; transient overvoltage 1.6 kVpk

CAT II 100 Vrms, 400 Vpk

with 10073C or 10074C 10:1 probe: CAT I 500 Vpk, CAT II 400 Vpk

To verify basic oscilloscope operation

If you have a 6000L Series oscilloscope, you will need to start a Web control session, as described on page 49.

- 1 Press the **Save/Recall** key on the front panel, then press the **Default Setup** softkey. (The softkeys are located directly below the display on the front panel.) The oscilloscope is now configured to its default settings (details on page 118).
- 2 Connect an oscilloscope probe from channel 1 to the **Probe Comp** signal terminal on the front panel.
- 3 Connect the probe's ground lead to the ground terminal that is next to the **Probe Comp** terminal.
- 4 Press **AutoScale**.

- 5 You should see a waveform on the oscilloscope's display similar to this:

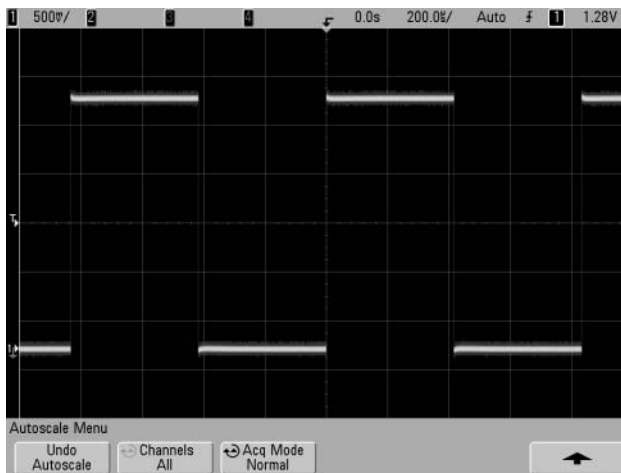

If you see the waveform, but the square wave is not shaped correctly as shown above, perform the procedure “To compensate the oscilloscope probes” on page 59.

If you do not see the waveform, ensure your power source is adequate, the oscilloscope is properly powered-on, and the probe is connected securely to the front-panel oscilloscope channel input BNC and to the Probe Comp terminal.

To compensate the oscilloscope probes

You should compensate your oscilloscope probes to match their characteristics to the oscilloscope's channels. A poorly compensated probe can introduce measurement errors.

- 1 Perform the procedure “To verify basic oscilloscope operation” on page 57.
- 2 Use a nonmetallic tool to adjust the trimmer capacitor on the probe for the flattest pulse possible. The trimmer capacitor is located on the probe BNC connector.

Perfectly compensated

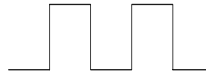

Over compensated



Under compensated



- 3 Connect probes to all other oscilloscope channels (channel 2 of a 2-channel oscilloscope, or channels 2, 3, and 4 of a 4-channel oscilloscope). Repeat the procedure for each channel. This matches each probe to each channel.

The process of compensating the probes serves as a basic test to verify that the oscilloscope is functional.

To calibrate the probes

The oscilloscope can accurately calibrate its analog oscilloscope channels to certain active probes, such as InfiniiMax probes. Other probes, such as the 10073C and 10074C passive probes, do not require calibration. The Calibrate Probe softkey will be grayed-out (displayed in faint text) when a connected probe does not require calibration.

When you connect a probe that can be calibrated (such as an InfiniiMax probe), the **Calibrate Probe** softkey in the channel's menu will become active. Connect the probe to the Probe Comp terminal, and the probe ground to the Probe Comp ground terminal. Press the **Calibrate Probe** softkey and follow the instructions on the display.

NOTE

When calibrating a differential probe, connect the positive lead to the Probe Comp terminal and the negative lead to the Probe Comp ground terminal. You may need to connect an alligator clip to the ground lug to allow a differential probe to span between the Probe Comp test point and ground. A good ground connection ensures the most accurate probe calibration.

Passive Probes Supported

The following passive probes can be used with the 6000 Series oscilloscopes. Any combination of passive probes can be used.

Table 8 Passive Probes

Passive Probes	Quantity Supported
10070C	4
10073C	4
10074C	4
10076A	4

Active Probes Supported

By 300 MHz, 500 MHz, and 1 GHz Bandwidth Models

Active probes that do not have their own external power supply require substantial power from the AutoProbe interface. (The AutoProbe interface is present on the 300 MHz, 500 MHz, and 1 GHz bandwidth models.) “Quantity Supported” indicates the maximum number of each type of active probe that can be connected to the oscilloscope. If too much current is drawn from the AutoProbe interface, an error message will be displayed, indicating that you must momentarily disconnect all probes to reset the AutoProbe interface.

Table 9 Active Probes for 300 MHz, 500 MHz, and 1 GHz bandwidth models

Active Probes	Quantity Supported
1130A	2
1131A	2
1132A	2
1134A	2
1141A with 1142A power supply	4
1144A with 1142A power supply	4
1145A with 1142A power supply	2
1147A	2
1156A	4
1157A	4
1158A	4
N2772A with N2773A power supply	4
N2774A with N2775A power supply	4

By 100 MHz Bandwidth Models

The following active probes use their own power supply. Therefore, they can be used on all 6000 Series oscilloscopes, including the 100 MHz bandwidth models.

Many active probes have a 50 Ω output impedance. The input impedance of 6000 Series 100 MHz bandwidth models is fixed at 1 M Ω . When connecting these probes to 6000 Series 100 MHz bandwidth models, a 50 Ω feedthrough terminator (such as Agilent part number 0960-0301 is required).

Table 10 Active Probes for All 6000 Series Oscilloscopes

Active Probes	Quantity Supported
1141A with 1142A power supply	4
1144A with 1142A power supply	4
1145A with 1142A power supply	2
N2772A with N2773A power supply	4
N2774A with N2775A power supply	4

Using Quick Help

To view Quick Help on 6000L Series oscilloscopes:

Start a Web browser control session as described on page 49 and select Remote Front Panel. To view Quick Help information, right-click on the softkey. Help is not available for front panel keys; only softkeys.

To view Quick Help on 6000A Series oscilloscopes

- 1 **Press** and **hold** down the key or softkey for which you would like to view help.

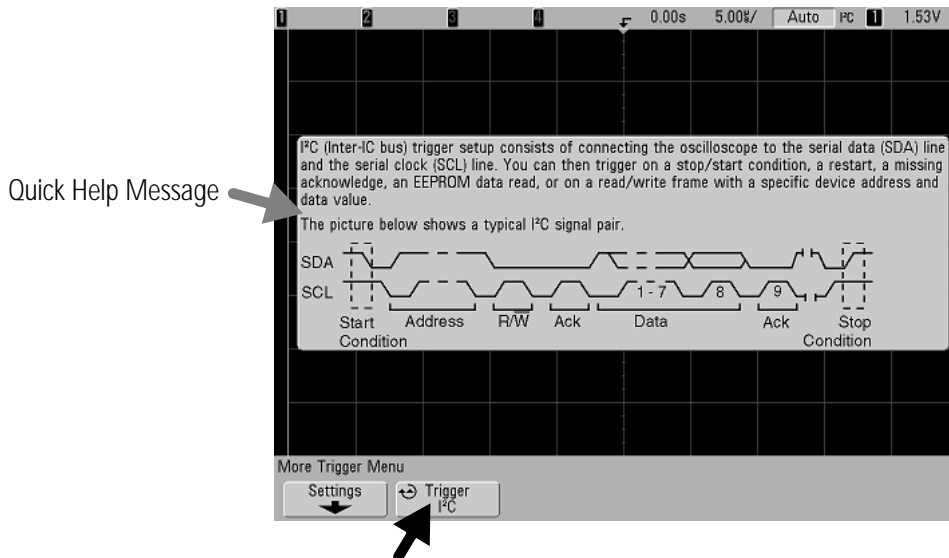

Press and Hold 6000A Front Panel Key or Softkey or Right-Click Softkey when using Web browser control

You can set Quick Help to close when you release the key (this is the default mode) or to remain on the screen until another key is pressed or a knob is turned. To select this mode, press the **Utility** key, then press the **Language** softkey, then press the **Help Remain/Help Close** softkey.

Quick Help Languages

To choose a Quick Help language in the oscilloscope:

- 1 Press **Utility**, then press the **Language** softkey.
- 2 Repeatedly press and release the **Language** softkey or rotate the Entry knob until the desired language is selected.

Graphical User Interface Languages

When Quick Help is set to one of the following languages, the Graphical User Interface (GUI) will be displayed in the language chosen.

- Simplified Chinese
- Traditional Chinese
- Japanese
- Korean

Quick Help Updates

Updated Quick Help for the 6000 Series oscilloscopes may be made available. To download new Quick Help and GUI language files:

- 1 Direct your web browser to www.agilent.com/find/6000sw.
- 2 Select **Quick Help Language Support** and follow the directions.

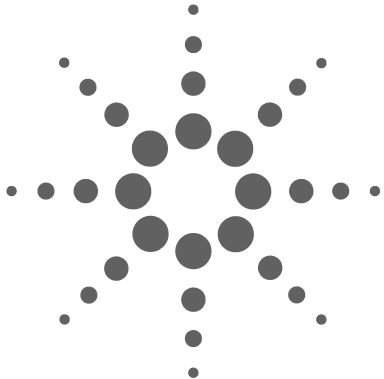

2 Front-Panel Controls

6000L Series Oscilloscope Controls 66

6000A Series Oscilloscope Front-Panel Controls 70

6000A Series Front-Panel Operation 83



6000L Series Oscilloscope Controls

The 6000L Series oscilloscope is designed to be remotely controlled. Therefore the front panel layout is simple.

Front Panel

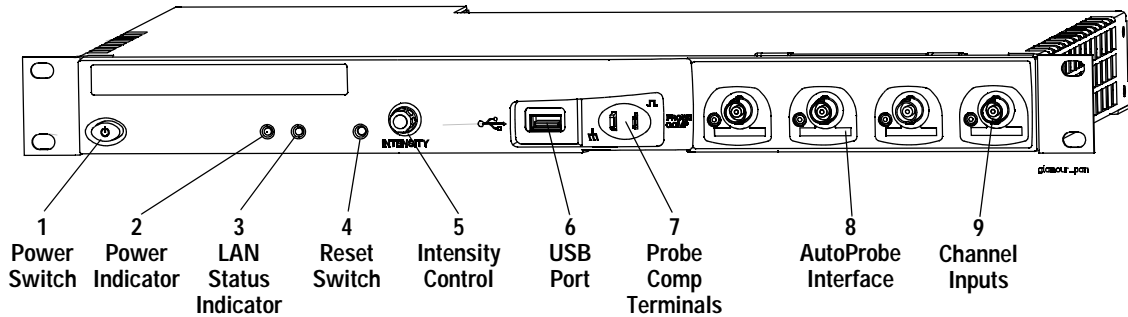

Rear Panel

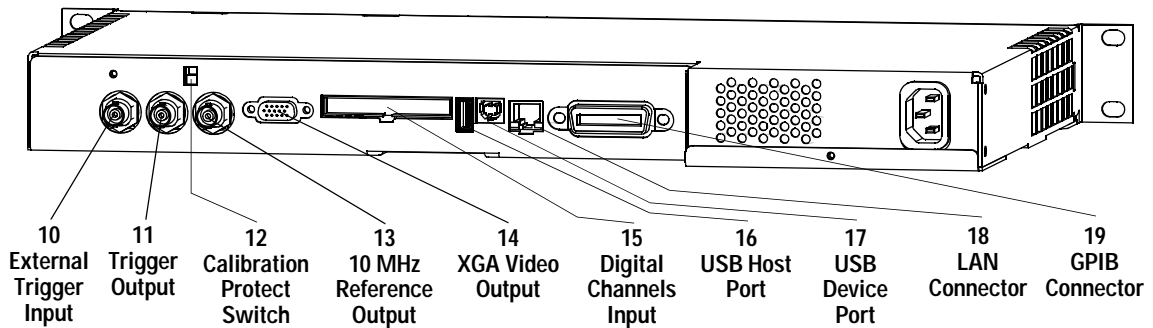

Front and Rear Panel Controls and Connectors

1. Power Switch Press once to switch power on; press again to switch power off. See page 38.

2. Power Indicator Illuminates green when power is on.

3. LAN Status Indicator This indicator illuminates green when a LAN connection has been detected and is connected as configured. The LAN status indicator illuminates red when the following LAN faults occur:

- failure to acquire a valid IP address
- detection of a duplicate IP address
- failure to renew an already acquired DHCP lease

The LAN status indicator flashes green when the identify function is activated (see page 54).

4. Reset Switch When power is on, press and release this recessed pushbutton to default LAN parameters. See page 45.

5. Intensity Control Rotate clockwise to increase analog waveform intensity; counterclockwise to decrease. You can vary the intensity control to bring out signal detail, much like an analog oscilloscope. Digital channel waveform intensity is not adjustable. More details about using the Intensity control to view signal detail are on page 275.

6. USB Host Port Connect a USB compliant mass storage device to store or recall oscilloscope setup files or waveforms. You can also use the USB port to update the oscilloscope's system software or Quick Help language files if updates are available. You do not need to take special precautions before removing the USB mass storage device from the oscilloscope (you do not need to "eject" it). Simply unplug the USB mass storage device from the oscilloscope when the file operation is complete. More information on using the USB port is given in Chapter 7, "Saving and Printing Data," starting on page 351.

CAUTION

Only connect USB devices to the USB host port. Do not attempt to connect a host computer to this port to control the oscilloscope. Use the USB device port if you want to connect a host (see the *InfiniVision 6000 Series Oscilloscope Programmer's Quick Start Guide* for details).

7. Probe Compensation Terminals Use the signal at these terminals to match each probe's characteristics to the oscilloscope channel to which it is connected. See page 59.

8. AutoProbe Interface (Not available on 100 MHz bandwidth models.) When you connect a probe to the oscilloscope, the AutoProbe Interface attempts to determine the type of probe and set its parameters in the Probe menu accordingly. See page 88. Note: Although the 100 MHz models lack the AutoProbe interface, they do have a probe sense ring around the BNC. Therefore, the probe attenuation factor will be automatically set when you connect a compatible probe such as the 10073C or 10074C.

9. Channel Input BNC Connector Attach the oscilloscope probe or BNC cable to the BNC connector. This is the channel's input connector.

10. External Trigger Input Allows you to trigger the oscilloscope using an external signal. See page 144.

11. Trigger Output This output is related to the oscilloscope's internal trigger signal. See page 212.

12. Calibration Protect Switch Set this switch to "Protect" to prevent unwanted re-calibration. See page 113.

13. 10 MHz Reference Input/Output You can input a signal, synchronizing multiple instruments, or you can output this instrument's reference signal. See page 378.

14. XGA Video Output You can connect an external display to the oscilloscope for viewing waveforms. See page 272.

15. Digital Channels Input If you purchased the MSO upgrade you can view and trigger on digital signals. See page 119.

16. USB Host Port Connect a USB compliant mass storage device to store or recall oscilloscope setup files or waveforms. You can also use the USB port to update the oscilloscope's system software or Quick Help language files if updates are available. You do not need to take special precautions before removing the USB mass storage device from the oscilloscope (you do not need to "eject" it). Simply unplug the USB mass storage device from the oscilloscope when the file operation is complete. More information on using the USB port is given in Chapter 7, "Saving and Printing Data," starting on page 351.

CAUTION

Only connect USB devices to the USB host port. Do not attempt to connect a host computer to this port to control the oscilloscope. Use the USB device port if you want to connect a host (see the *InfiniiVision 6000 Series Oscilloscope Programmer's Quick Start Guide* for details).

17. USB Device Port You can use this port for remote control of the oscilloscope by connecting to a PC host computer. See the *InfiniiVision 6000 Series Oscilloscope Programmer's Quick Start Guide* for details.

18. LAN Connector You can use this port to connect to the oscilloscope and control it via your LAN. This standard LAN port is not Auto-MDIX compliant. See page 43 or page 45.

19. GPIB Connector This connector is for connecting the oscilloscope to a General Purpose Interface Bus. See the *InfiniiVision 6000 Series Oscilloscope Programmer's Quick Start Guide* for details.

6000A Series Oscilloscope Front-Panel Controls

This is an introduction to the front-panel controls of the Agilent 6000A Series oscilloscope. Generally, you set up the front-panel controls and then make a measurement.

The keys on the front panel bring up softkey menus on the display that provide access to oscilloscope features. Many softkeys use the Entry knob  to select values.

Six softkeys are located below the display. To understand the symbols used in the softkey menus and throughout this guide, see “Conventions” on page 71.

Note that the Digital Select key, not the Entry knob, is used to select digital channels when you want to reposition a digital channel waveform.

NOTE

The simplest way to set up the oscilloscope is to connect it to the signals of interest and press the **AutoScale** key.

Conventions



Throughout this book, the front-panel keys and softkeys are denoted by a change in font. For example, the **Cursors** key is in the Measure section of the front panel. The **Acq Mode** softkey is the left-most softkey when the Acquire menu is displayed.

In this manual, instructions for pressing a series of keys are written in an abbreviated manner. Pressing the **Utility** key, then the **I/O** softkey, then the **Show I/O Config** softkey is abbreviated as follows:

Press **Utility & I/O & Show I/O Config**.

Graphic Symbols in Softkey Menus

The following graphic symbols appear in the oscilloscope's softkey menus. The softkey menus appear at the bottom of the display, just above the six softkeys.

 Use the Entry knob to adjust the parameter. The Entry knob is located on the front panel. The  symbol above the knob is illuminated when this control is active.

 Press the softkey to display a pop up with a list of choices. Repeatedly press the softkey until your choice is selected.

 Use the Entry knob labeled  and/or press the softkey to adjust the parameter.

 Press the softkey to display a pop-up menu. Press the softkey or rotate and push the Entry knob to make an item active.

 Option is selected but not active.

 Option is selected and active.

 Feature is on. Press the softkey again to turn the feature off.

 Feature is off. Press the softkey again to turn the feature on.

 Press the softkey to view the menu.

 Press the softkey to return to the previous menu.

4-Channel 6000A Series Oscilloscope Front Panel

The following diagram shows the front panel of the 6000A Series 4-channel oscilloscopes. The controls of the 2-channel oscilloscopes are very similar. For a diagram showing the differences of the 2-channel oscilloscope, see page 79.

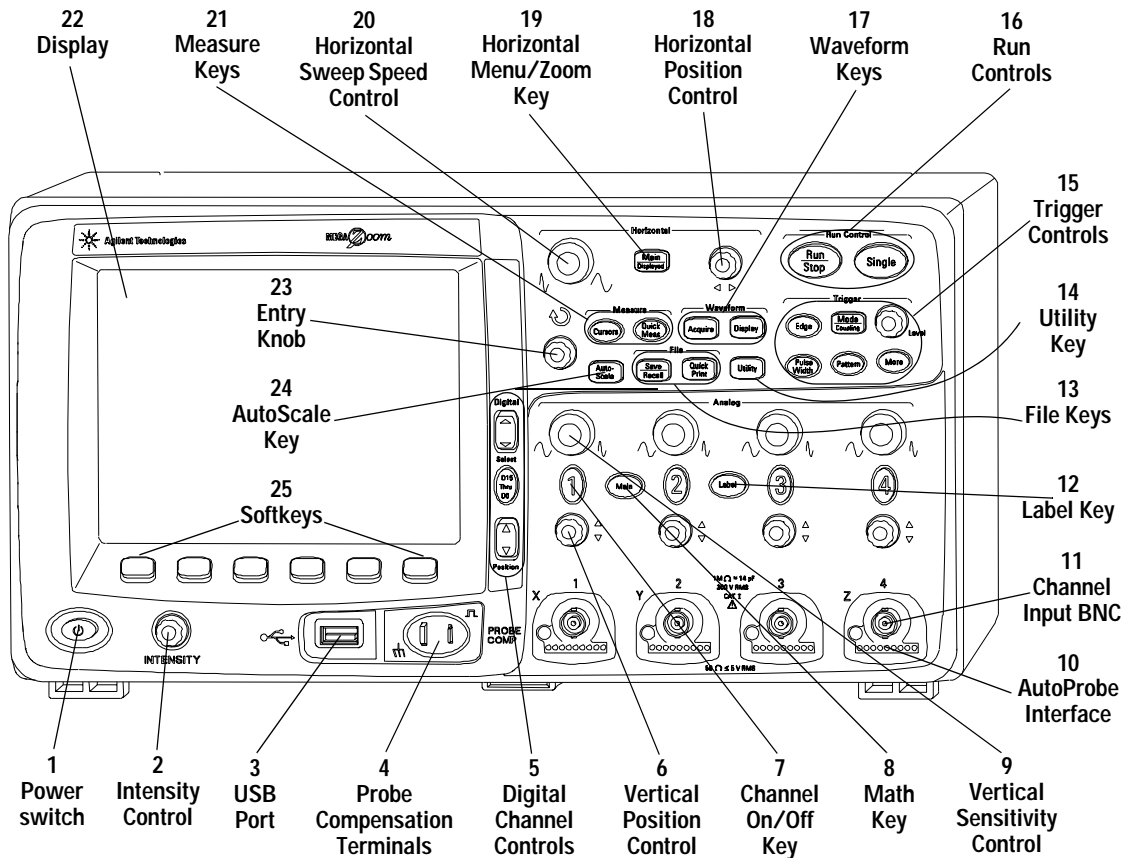

Figure 6 6000A Series 4-Channel Oscilloscope Front Panel

Front Panel Controls

1. Power Switch Press once to switch power on; press again to switch power off. See page 38.

2. Intensity Control Rotate clockwise to increase analog waveform intensity; counterclockwise to decrease. You can vary the intensity control to bring out signal detail, much like an analog oscilloscope. Digital channel waveform intensity is not adjustable. More details about using the Intensity control to view signal detail are on page 275.

3. USB Host Port Connect a USB compliant mass storage device to store or recall oscilloscope setup files or waveforms. You can also use the USB port to update the oscilloscope's system software or Quick Help language files if updates are available. You do not need to take special precautions before removing the USB mass storage device from the oscilloscope (you do not need to "eject" it). Simply unplug the USB mass storage device from the oscilloscope when the file operation is complete. More information on using the USB port is given in Chapter 7, "Saving and Printing Data," starting on page 351.

CAUTION

Only connect USB devices to the USB host port. Do not attempt to connect a host computer to this port to control the oscilloscope. Use the USB device port if you want to connect a host (See the *InfiniiVision 6000 Series Oscilloscope Programmer's Quick Start Guide* for details).

4. Probe Compensation Terminals Use the signal at these terminals to match each probe's characteristics to the oscilloscope channel to which it is connected. See page 59.

5. Digital Channel Controls These controls switch the digital channels on/off, and can be used to select a digital channel for repositioning on the display. You can press the D15 Thru D0 key to show the Digital Channel Menu above the softkeys. See Chapter 3, "Viewing and Measuring Digital Signals," starting on page 119.

6. Vertical Position Control Use this knob to change the channel's vertical position on the display. There is one Vertical Position control for each channel. See "Using the analog channels" on page 90.

7. Channel On/Off Key Use this key to switch the channel on or off, or to access the channel's menu in the softkeys. There is one Channel On/Off key for each channel. See "Using the analog channels" on page 90.

8. Math Key The Math key provides access to add, subtract, multiply, differentiate, integrate, FFT (Fast Fourier Transform) and square root functions. See "Math Functions" on page 219.

9. Vertical Sensitivity Use this knob to change the vertical sensitivity (gain) of the channel. See "Using the analog channels" on page 90.

10. AutoProbe Interface (Not available on 100 MHz bandwidth models.) When you connect a probe to the oscilloscope, the AutoProbe Interface attempts to determine the type of probe and set its parameters in the Probe menu accordingly. See page 88. Note: Although the 100 MHz models lack the AutoProbe interface, they do have a probe sense ring around the BNC. Therefore, the probe attenuation factor will be automatically set when you connect a compatible probe such as the 10073C or 10074C.

11. Channel Input BNC Connector Attach the oscilloscope probe or BNC cable to the BNC connector. This is the channel's input connector.

12. Label Key Press this key to access the Label menu, which lets you enter labels to identify each trace on the oscilloscope display. See page 105.

13. File Keys Press the File key to access file functions such as save or recall a waveform or setup. Or press the Print key (labeled Quick Print on older models) to print the waveform from the display. See "Saving and Printing Data" on page 351.

14. Utility Key Press this key to access the Utility menu, which lets you configure the oscilloscope's I/O settings, printer configuration, file explorer, service menu, and other options.

15. Trigger Controls These controls determine how the oscilloscope triggers to capture data. See “Choosing Auto trigger mode or Normal trigger mode” on page 87 and Chapter 4, “Triggering the Oscilloscope,” starting on page 135.

16. Run Controls Press Run/Stop to make the oscilloscope begin looking for a trigger. The Run/Stop key will illuminate in green. If the trigger mode is set to “Normal,” the display will not update until a trigger is found. If the trigger mode is set to “Auto,” the oscilloscope looks for a trigger, and if none is found, it will automatically trigger, and the display will immediately show the input signals. In this case, the **Auto** indicator at the top of the display will change to **Auto?** and the background will flash, indicating that the oscilloscope is forcing triggers.

Press Run/Stop again to stop acquiring data. The key will illuminate in red. Now you can pan across and zoom-in on the acquired data.

Press Single to make a single acquisition of data. The key will illuminate in yellow until the oscilloscope triggers. See “To start and stop an acquisition” on page 84.

17. Waveform Keys The Acquire key lets you set the oscilloscope to acquire in Normal, Peak Detect, Averaging, or High Resolution modes (see “Acquisition Modes” on page 277), and lets you turn Realtime sampling off or on (see page 281). The Display key lets you access the menu where you can select infinite persistence (see page 273), switch vectors on or off (see page 274), and adjust the display grid (graticule) intensity (see page 274).

18. Horizontal Position Control Turn the knob marked ◀▶ to pan through the waveform data horizontally. You can see the captured waveform before the trigger (turn the knob clockwise) or after the trigger (turn the knob counterclockwise). If you pan through the waveform when the oscilloscope is stopped (not in

Run mode) then you are looking at the waveform data from the last acquisition taken. See “To set up the Horizontal time base” on page 95.

19. Horizontal Menu/Zoom Key (Labeled **Main/Delayed** on older models.) Press this key to access the menu where you can split the oscilloscope display into Normal and Zoom sections, and where you can select XY and Roll modes. You can also select horizontal time/division vernier and select the trigger time reference point on this menu. See “To set up the Horizontal time base” on page 95.

20. Horizontal Sweep Speed Control Turn the knob in the Horizontal section that is marked  to adjust the sweep speed. The symbols under the knob indicate that this control has the effect of spreading out or zooming in on the waveform using the horizontal scale. The horizontal sweep speed control changes the time per horizontal division on the display. See “To set up the Horizontal time base” on page 95.

21. Measure Keys Press the Cursors key to switch on cursors that you can use for making measurements. Press the **Quick Meas** key to access a set of predefined measurements. See Chapter 5, “Making Measurements,” starting on page 213.

22. Display The display shows captured waveforms using a different color for each channel. For more information about display modes see Chapter 6, “Displaying Data,” starting on page 269. Signal detail is displayed using 256 levels of intensity. For more information about viewing signal detail see “Varying the intensity to view signal detail” on page 275.

23. Entry Knob The entry knob is used to select items from menus and to change values. Its function changes based upon which menu is displayed. Note that the curved arrow symbol  above the entry knob illuminates whenever the entry knob can be used to select a value. Use the entry knob to select among the choices that are shown on the softkeys.

24. AutoScale Key When you press the AutoScale key the oscilloscope will quickly determine which channels have activity, and it will turn these channels on and scale them to display the input signals. See “How AutoScale Works” on page 348

25. Softkeys The functions of these keys change based upon the menus shown on the display directly above the keys.

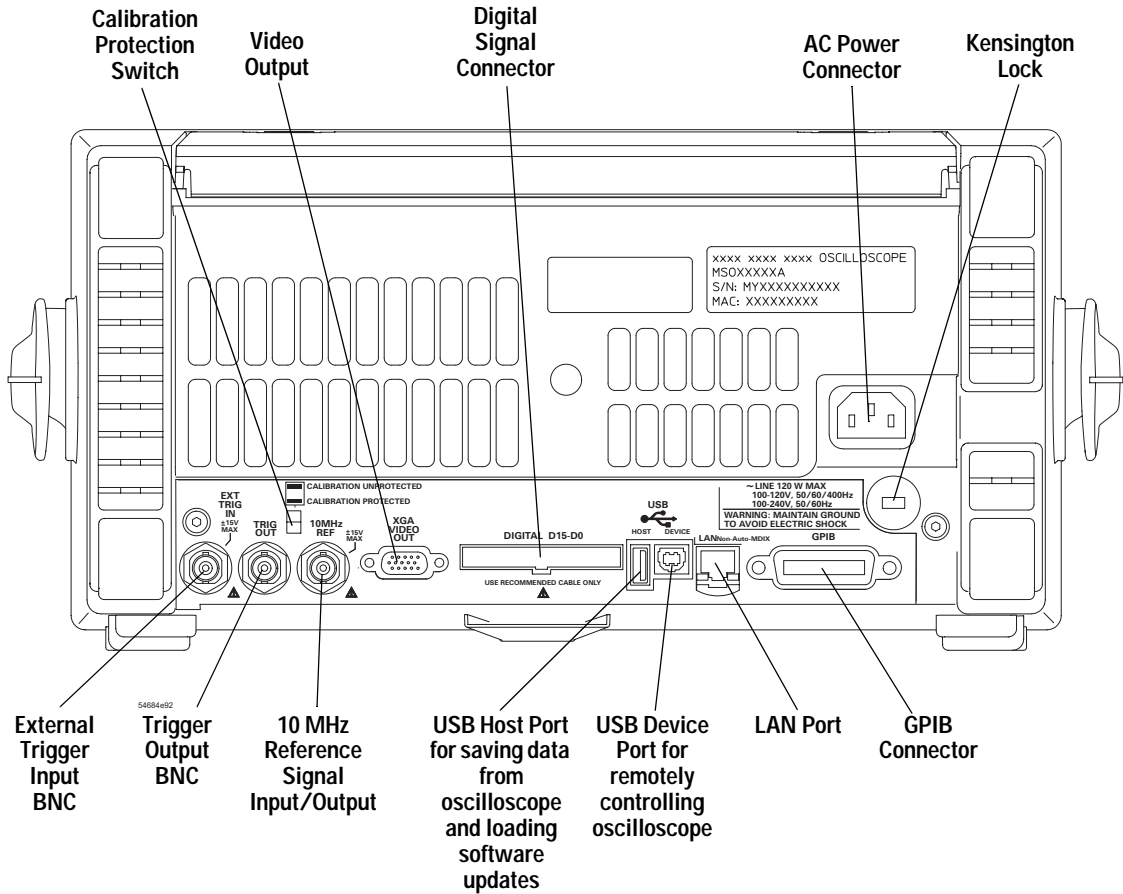

Figure 7 InfiniiVision 6000 Series 4-Channel Oscilloscope Rear Panel

2-Channel 6000A Series Oscilloscope Front Panel (differences only)

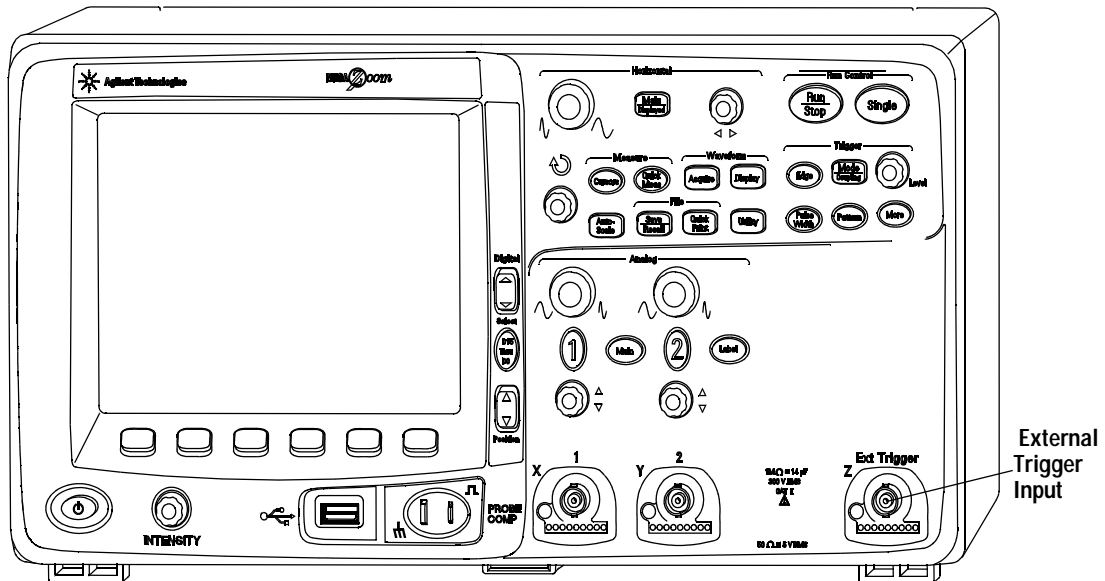

Figure 8 6000A Series 2-Channel Oscilloscope Front Panel

The differences between the front panel of the 4-channel oscilloscopes and the 2-channel oscilloscopes are:

- The 2-channel oscilloscope has two sets of channel controls
- The 2-channel oscilloscope's external trigger input is on the front panel instead of the rear panel. Some trigger features differ. See "The External Trigger input" on page 144.

2 Front-Panel Controls

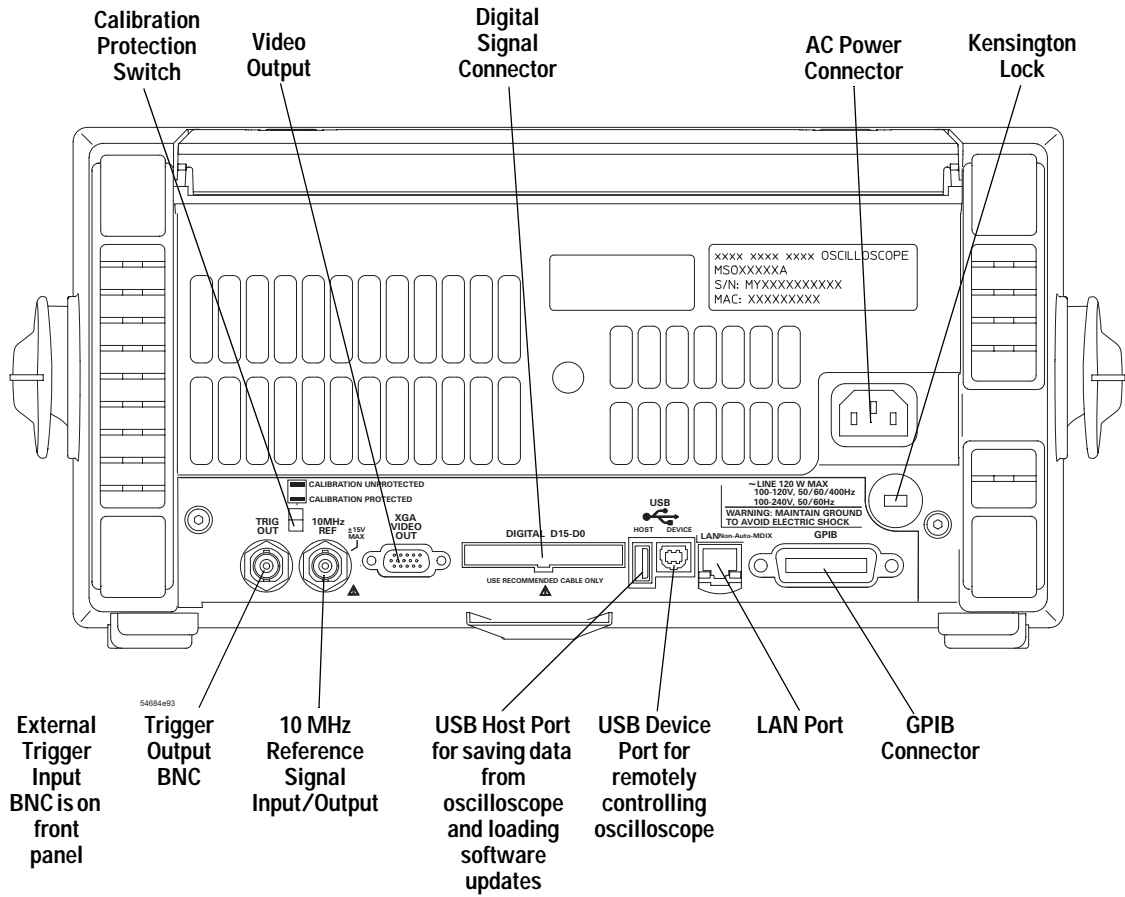

Figure 9 InfiniiVision 6000 Series 2-Channel Oscilloscope Rear Panel

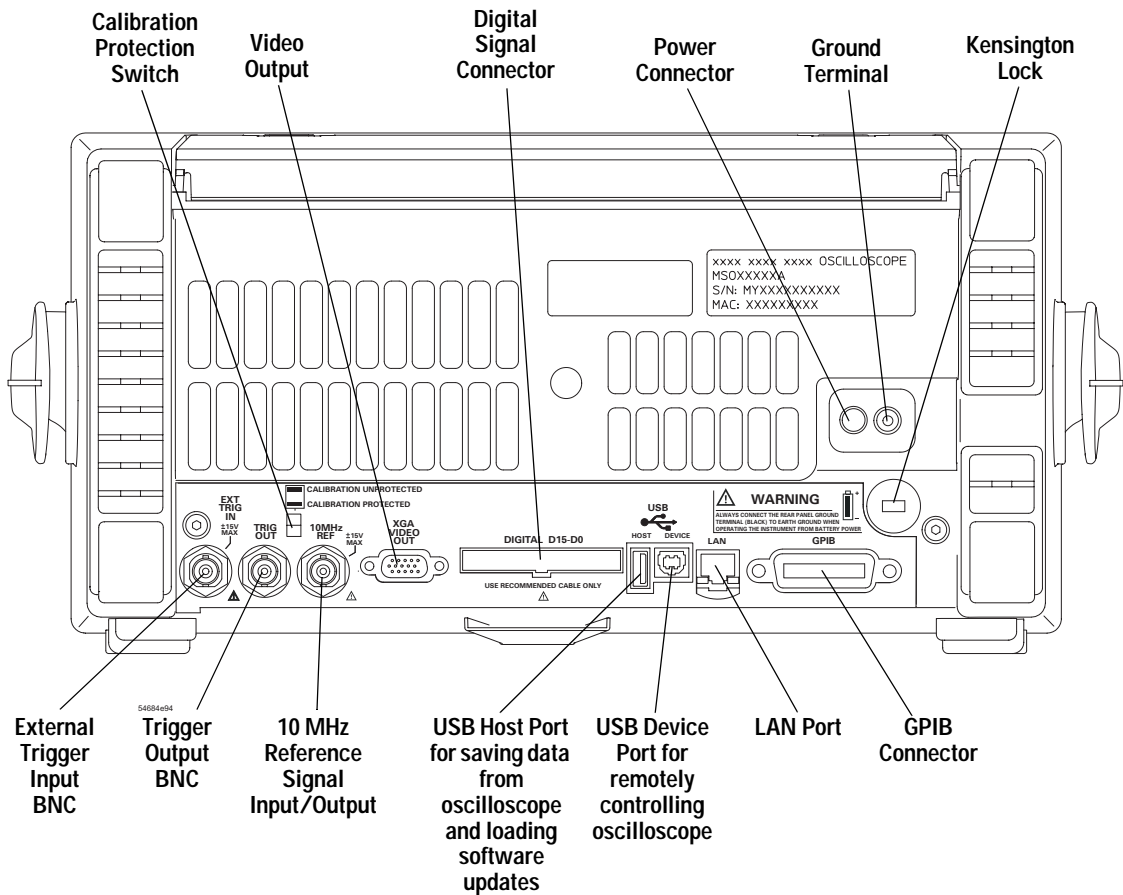

Figure 10 InfiniiVision 6000 Series Oscilloscope Option BAT Rear Panel

WARNING

Maintain oscilloscope ground connection on Option BAT oscilloscopes. Do not negate the protective action of the ground connection to the oscilloscope. If the circuit under test has voltages greater than 30 Vrms, the oscilloscope must be grounded through its ground terminal to prevent electric shock to the user.

Interpreting the display

The oscilloscope display contains acquired waveforms, setup information, measurement results, and softkeys for setting up parameters.

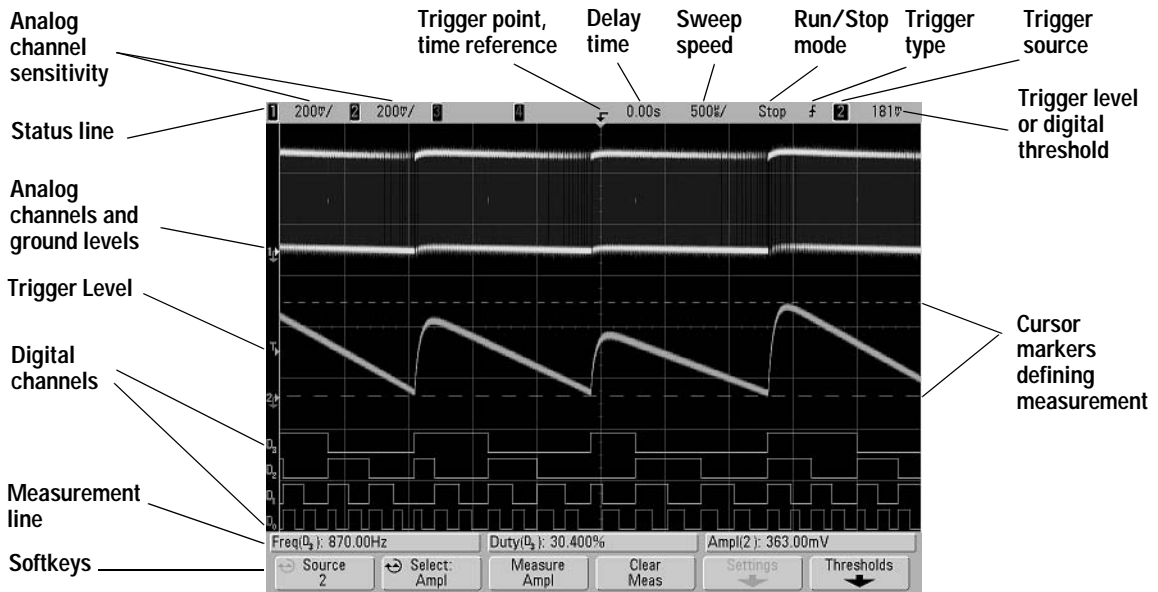

Figure 11 Interpreting the display

Status line The top line of the display contains vertical, horizontal, and trigger setup information.

Display area The display area contains the waveform acquisitions, channel identifiers, and analog trigger and ground level indicators. Each analog channel's information appears in a different color.

Measurement line This line normally contains automatic measurement and cursor results, but can also display advanced trigger setup data and menu information.

Softkeys The softkeys let you set up additional parameters for the selected mode or menu.

6000A Series Front-Panel Operation

This section provides a brief overview of operating the front-panel controls. Detailed oscilloscope operating instructions are provided in later chapters.

Digital Channels

Because all of the oscilloscopes in the 6000 Series have analog channels, the analog channel topics in this book apply to all instruments. Whenever a topic discusses the digital channels, that information applies only to Mixed-Signal Oscilloscope (MSO) models or DSO models that have been upgraded to an MSO.

To adjust the waveform intensity

The Intensity control is at the lower left corner of the front panel near the power switch.

- To decrease waveform intensity, rotate the **Intensity** control counter-clockwise.
- To increase waveform intensity, rotate the **Intensity** control clockwise.

The intensity control does not affect digital channel intensity. Digital channel intensity is fixed.

To adjust the display grid (graticule) intensity

- 1 Press the **Display** key.
- 2 Turn the Entry knob  to change the intensity of the displayed grid. The intensity level is shown in the **Grid** softkey and is adjustable from 0 to 100%.

Each major vertical division in the grid corresponds to the vertical sensitivity shown in the status line at the top of the display.

Each major horizontal division in the grid corresponds to the sweep speed time shown in the status line at the top of the display.

NOTE

To change the analog waveform intensity, turn the Intensity knob at the lower-left corner of the front panel. The digital waveform intensity is not adjustable.

To start and stop an acquisition

- When you press the **Run/Stop** key, it illuminates in green and the oscilloscope is in continuous running mode.

The oscilloscope examines the input voltage at each probe, and updates the display whenever the trigger conditions are met. Trigger processing and screen update rate are optimized based on the oscilloscope settings. The oscilloscope displays multiple acquisitions of the same signal similar to the way an analog oscilloscope displays waveforms.

- When you press the **Run/Stop** key again, it illuminates in red, and the oscilloscope is stopped.

“Stop” is displayed in the trigger mode position in the status line at the top of the display. You can pan and zoom the stored waveform by turning the horizontal and vertical control knobs.

- To manually run and stop 6000L models start the Remote Front Panel (see page 49) and select **Run Control** from the Main Menu or press ctrl+R for run/stop or ctrl+S for single.

When the oscilloscope is running and you press the **Run/Stop** key, it will flash until the current acquisition is completed. If the acquisition completes immediately, the **Run/Stop** key will not flash.

At slower sweep speeds, you may not want to wait for the acquisition to finish. Just press **Run/Stop** again. The acquisition will stop immediately and a partial waveform will be displayed.

You can display the results of multiple acquisitions using infinite persistence. See “Infinite persistence” on page 273.

Memory Depth/Record Length**Run/Stop versus Single**

When the oscilloscope is running, the trigger processing and update rate are optimized over the memory depth.

Single

Single acquisitions always use the maximum memory available—at least twice as much memory as acquisitions captured in Run mode—and the oscilloscope stores at least twice as many samples. At slow sweep speeds, the oscilloscope operates at a higher sample rate when Single is used to capture an acquisition due to the increased memory available. To acquire data with the longest possible record length, press the **Single** key.

Running

When running, versus taking a single acquisition, the memory is divided in half. This allows the acquisition system to acquire one record while processing the previous acquisition, dramatically improving the number of waveforms per second processed by the oscilloscope. While running, maximizing the rate at which waveforms are drawn on the display provides the best picture of your input signal.

To make a single acquisition

When you press the **Single** key it illuminates in yellow and the oscilloscope starts the acquisition system, searching for the trigger condition. When the trigger condition is met, the captured waveform is displayed, the **Single** key is extinguished and the **Run/Stop** key illuminates in red.

- Use the **Single** key to view single-shot events without subsequent waveform data overwriting the display.
- To manually make a single acquisition on 6000L models start the Remote Front Panel (see page 49) and select **Run Control** from the Main Menu or press ctrl+S for single.

Use Single when you want the maximum sample rate and the maximum memory depth for pan and zoom. (See “To pan and zoom” on page 86)

- 1 Set the trigger mode to Normal (see “Trigger modes: Normal and Auto” on page 139 for instructions).

This keeps the oscilloscope from automatically triggering immediately.

2 If you are triggering on analog channel events, turn the Trigger Level knob to the trigger threshold to a level that your waveform will cross.

3 To begin a single acquisition, press the **Single** key.

When you press **Single**, the display is cleared, the trigger circuitry is armed, the **Single** key is illuminated yellow, and the oscilloscope will wait until a trigger condition occurs before it displays a waveform.

When the oscilloscope triggers, the single acquisition is displayed and the oscilloscope is stopped (the **Run/Stop** key is illuminated in red).

4 To acquire another waveform, press **Single** again.

Auto Single

Auto-trigger will generate a trigger for you if one is not found in the predetermined time (about 40 ms) after you press **Single**. If you want to make a single acquisition and you are not particularly interested in triggering the acquisition (for example, if you are probing a DC level), set the trigger mode to Auto (see page 139) and press the **Single** key. If a trigger condition occurs, it will be used; if a trigger doesn't happen, an untriggered acquisition will be taken.

To pan and zoom

You can pan across and zoom-in on a waveform even when the acquisition system is stopped.

1 Press the **Run/Stop** key to stop acquisitions (or press the **Single** key and allow the oscilloscope to acquire the waveform and stop). The **Run/Stop** key is illuminated red when the oscilloscope is stopped.

2 Turn the sweep speed knob to zoom horizontally and turn the volts/division knob to zoom vertically.

The ∇ symbol at the top of the display indicates the time reference point where the zoom-in/zoom-out is referenced.

- 3 Turn the Horizontal Position knob (◀▶) to pan horizontally and turn the channel's vertical position knob (◆) to pan vertically.

The stopped display may contain several triggers worth of information, but only the last trigger acquisition is available for pan and zoom.

For more information about Pan and Zoom see page 270.

Choosing Auto trigger mode or Normal trigger mode

In Auto trigger mode, the oscilloscope automatically triggers and captures waveforms when you press **Run**.

If you press **Run** when the oscilloscope is in Normal trigger mode, a trigger must be detected before an acquisition can complete.

In many cases, a triggered display is not needed to check signal levels or activity. For these applications, use Auto trigger mode (which is the default setting). If you only want to acquire specific events as specified by the trigger settings, use Normal trigger mode.

You can select the trigger mode by pressing the **Mode/Coupling** key, then the **Mode** softkey.

For more detailed discussion of Auto trigger mode and Normal trigger mode, see “Trigger modes: Normal and Auto” on page 139.

Using AutoScale

To configure the oscilloscope quickly, press the **AutoScale** key to display the connected signal(s) that are active.

To undo the effects of AutoScale, press the **Undo AutoScale** softkey before pressing any other key. This is useful if you have unintentionally pressed the **AutoScale** key or do not like the settings AutoScale has selected and want to return to your previous settings.

To make the oscilloscope remain in the acquisition mode you have chosen, press the **AutoScale Acq Mode** softkey and select **Preserve Acquisition Mode**. Otherwise, the acquisition mode will default to **Normal** whenever the **AutoScale** key is pressed.

Example

Connect the oscilloscope probes for channels 1 and 2 to the Probe Comp output on the front panel of the instrument. Be sure to connect the probe ground leads to the ground lug beside the Probe Comp output. Set the instrument to the factory default configuration by pressing the **Save/Recall** key, then the **Default Setup** softkey. Then press the **AutoScale** key. You should see a display similar to the one shown below.

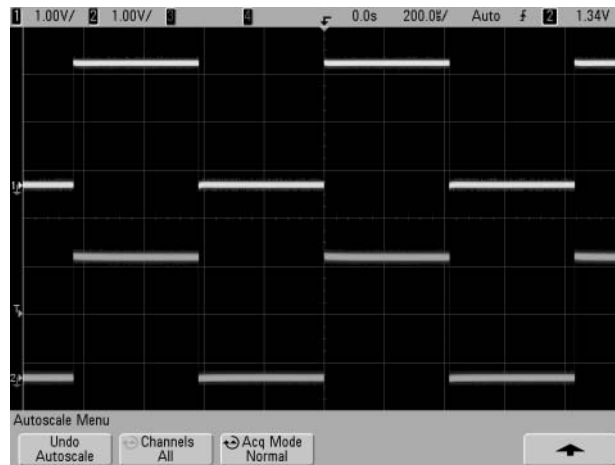

Figure 12 AutoScale of oscilloscope channels 1 and 2

For an explanation of how AutoScale works, see “How AutoScale Works” on page 348.

To set the probe attenuation factor

Passive Probes

All 6000 Series oscilloscopes including the 100 MHz models recognize passive probes such as the 10073C and 10074C. These probes have a pin on their connector that connects to the ring

around the oscilloscope's BNC connector. Therefore, the oscilloscope will automatically set the attenuation factor for recognized Agilent passive probes.

Passive probes that do not have a pin that connects to the ring around the BNC connector will not be recognized by the oscilloscope, and you must set the probe attenuation factor manually.

Active Probes

All 6000 Series oscilloscopes except the 100 MHz bandwidth models (MSO/DSO6012A and MSO/DSO6014A/L) have an AutoProbe interface. Most Agilent active probes are compatible with the AutoProbe interface. The AutoProbe interface uses a series of contacts directly below the channel's BNC connector to transfer information between the oscilloscope and the probe. When you connect a compatible probe to the oscilloscope, the AutoProbe interface determines the type of probe and sets the oscilloscope's parameters (units, offset, attenuation, coupling, and impedance) accordingly.

Manually Setting the Probe Attenuation Factor

If you connect a probe that the oscilloscope does not automatically identify, you can set the attenuation factor as follows:

- 1 Press the channel key
- 2 Press the **Probe** softkey
- 3 Turn the Entry knob  to set the attenuation factor for the connected probe.

The attenuation factor can be set from 0.1:1 to 1000:1 in a 1-2-5 sequence for measuring voltage. The attenuation factor can be set from 10 V/A to .001V/A to for measuring current values with a current probe. The probe attenuation factor must be set properly for measurements to be made correctly.

Using the analog channels

Connect the oscilloscope probes for channels 1 and 2 to the Probe Comp output on the front panel of the instrument.

- 1 Press the 1 key in the Analog section of the oscilloscope's front panel to display the Channel 1 menu.

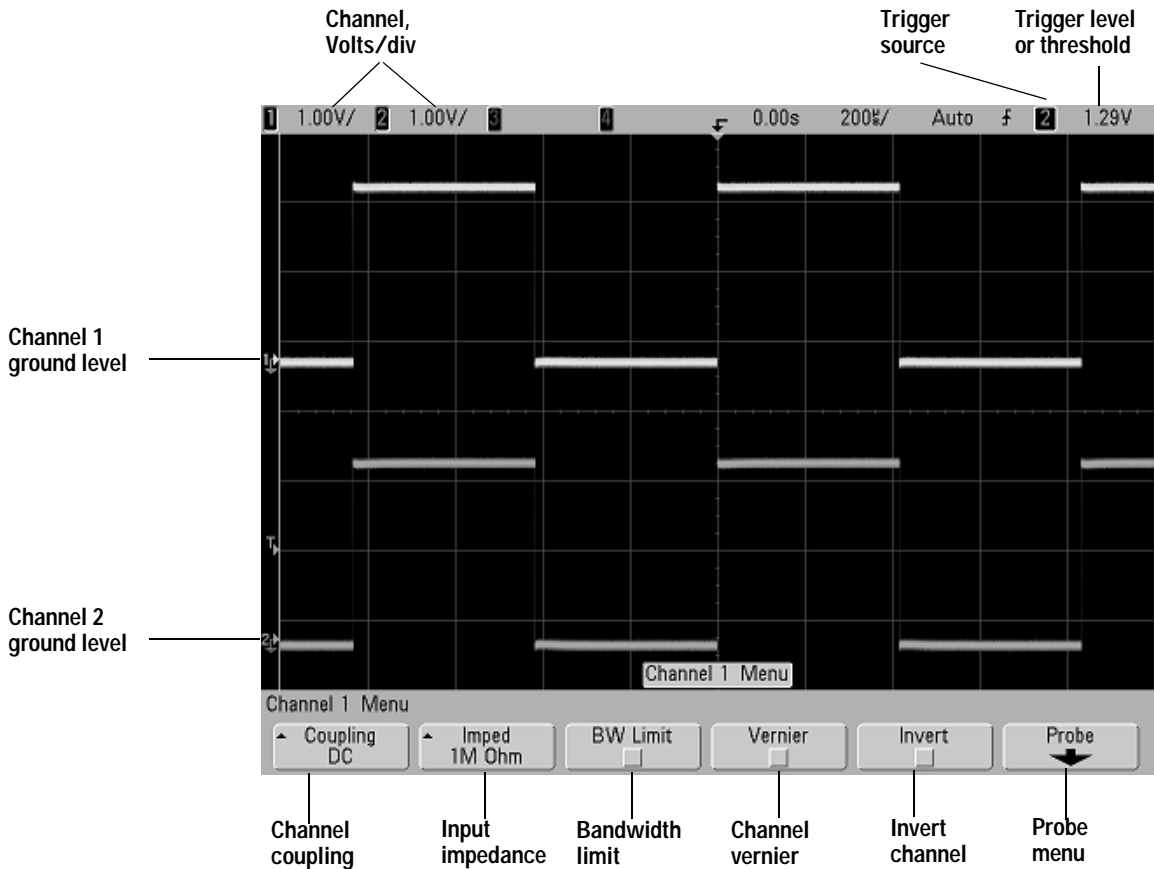

Pressing an analog channel key displays the channel's menu and turns the display of the channel on or off. The channel is displayed when the key is illuminated.

On 6000L models, select **Analog** from the Main Menu and use the menu.

Turning channels off

You must be viewing the menu for a channel before you can turn it off. For example, if channel 1 and channel 2 are turned on and the menu for channel 2 is being displayed, to turn channel 1 off, press 1 to display channel 1 menu, then press 1 again to turn channel 1 off.



Vertical sensitivity Turn the large knob above the channel key to set the sensitivity (volts/division) for the channel. The vertical sensitivity knob changes the analog channel sensitivity in a 1-2-5 step sequence (with a 1:1 probe attached). The analog channel Volts/Div value is displayed in the status line.

Vernier Press the **Vernier** softkey to turn on vernier for the selected channel. When Vernier is selected, you can change the channel's vertical sensitivity in smaller increments. The channel sensitivity remains fully calibrated when Vernier is on. The vernier value is displayed in the status line at the top of the display.

When Vernier is turned off, turning the volts/division knob changes the channel sensitivity in a 1-2-5 step sequence.

Vertical expansion The default mode for expanding the signal when you turn the volts/division knob is vertical expansion about the ground level of the channel. To set the expansion mode to expand about the center of the screen instead, press **Expand** in the **Utility&Options&Preferences&Expand** menu and select **Center**.

Ground level The ground level of the signal for each displayed analog channel is identified by the position of the  icon at the far-left side of the display.

Vertical position Turn the small vertical position knob () to move the channel's waveform up or down on the display. The voltage value momentarily displayed in the upper right portion of the display represents the voltage difference between the vertical center of the display and the ground level () icon. It also represents the voltage at the vertical center of the display if vertical expansion is set to expand about ground.

Measurement Hints

If the channel is DC coupled, you can quickly measure the DC component of the signal by simply noting its distance from the ground symbol.

If the channel is AC coupled, the DC component of the signal is removed, allowing you to use greater sensitivity to display the AC component of the signal.

- 2 Press the channel's on/off key, then press the **Coupling** softkey to select the input channel coupling.

Coupling changes the channel's input coupling to either **AC** (alternating current) or **DC** (direct current). AC coupling places a 3.5 Hz high-pass filter in series with the input waveform that removes any DC offset voltage from the waveform. When **AC** is selected, "AC" is illuminated on the front panel next to the channel position knob (◆).

- DC coupling is useful for viewing waveforms as low as 0 Hz that do not have large DC offsets.
- AC coupling is useful for viewing waveforms with large DC offsets. When AC coupling is chosen, you cannot select 50Ω mode. This is done to prevent damage to the oscilloscope.

Note that Channel Coupling is independent of Trigger Coupling. To change Trigger coupling see page 141.

- 3 Press the **Imped** (impedance) softkey.

NOTE

The input impedance of the MSO/DSO6012A and MSO/DSO6014A/L (100 MHz bandwidth) oscilloscope is fixed at 1 MΩ. Therefore, the impedance selection is not available on these models.

When you connect an AutoProbe, self-sensing probe, or a compatible InfiniiMax probe, the oscilloscope will automatically configure the oscilloscope to the correct impedance.

The analog channel input impedance can be set to either **1M Ohm** or **50 Ohm** by pressing the **Imped** softkey.

- **50 Ohm** mode matches 50-ohm cables commonly used in making high frequency measurements, and 50-ohm active probes. This impedance matching gives you the most accurate measurements since reflections are minimized along the signal path. When **50 Ohm** is selected, “50Ω” is illuminated on the front panel next to the channel position knob. The oscilloscope automatically switches to **1 M Ohm** mode to prevent possible damage if AC coupling is selected.
- **1M Ohm** mode is for use with many passive probes and for general-purpose measurements. The higher impedance minimizes the loading effect of the oscilloscope on the circuit under test.

4 Press the **BW Limit** softkey to turn on bandwidth limiting.

Pressing the **BW Limit** softkey turns the bandwidth limit on or off for the selected channel. When bandwidth limit is on, the maximum bandwidth for the channel is approximately 25 MHz on the 300 MHz, 500 MHz, and 1 GHz bandwidth oscilloscope models and approximately 20 MHz for the 100 MHz bandwidth oscilloscope models. For waveforms with frequencies below this, turning bandwidth limit on removes unwanted high frequency noise from the waveform. The bandwidth limit also limits the trigger signal path of any channel that has **BW Limit** turned on.

When **BW Limit** is selected, “BW” is illuminated on the front panel next to the channel position knob (◆).

5 Press the **Invert** softkey to invert the selected channel.

When **Invert** is selected, the voltage values of the displayed waveform are inverted. **Invert** affects how a channel is displayed, but does not affect triggering. If the oscilloscope is set to trigger on a rising edge, it remains set to trigger on a same edge (triggers at the same point on the waveform) after the channel is inverted.

Inverting a channel will also change the result of any function selected in the Math menu or any measurement.

6 Press the **Probe** softkey to display the channel probe menu.

This menu lets you select additional probe parameters such as attenuation factor and units of measurement for the connected probe.

Probe calibration not needed, not available when this softkey is ghosted.

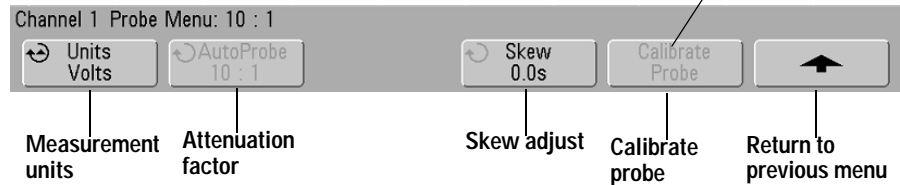

- **Probe Units** – Press the **Units** softkey to select the proper measurement unit for the connected probe. Select **Volts** for a voltage probe and select **Amps** for a current probe. Channel sensitivity, trigger level, measurement results, and math functions will reflect the measurement units you have selected.
- **Probe Attenuation Factor**– See “To set the probe attenuation factor” on page 88.
- **Skew** – When measuring time intervals in the ns range, small differences in cable length can affect the measurement. Use **Skew** to remove cable-delay errors between any two channels.

Probe the same point with both probes, then press **Skew** and turn the Entry knob to enter the amount of skew between channels. Each analog channel can be adjusted ± 100 ns in 10 ps increments for a total of 200 ns difference.

The skew setting is reset to zero when you press **Save/Recall&Default Setup**.

- **Probe Units** – Press the **Units** softkey to select the proper measurement unit for the connected probe. Select **Volts** for a voltage probe and select **Amps** for a current probe. Channel sensitivity, trigger level, measurement results, and math functions will reflect the measurement units you have selected.

- **Calibrate Probe** – See “To calibrate the probes” on page 60.

To set up the Horizontal time base

- 1 Press the **Menu/Zoom** key (labeled **Main/Delayed** on older models) in the Horizontal section of the front panel.

To manually control the horizontal time base on 6000L models start the Remote Front Panel (see page 49) and select **Horizontal** from the Main Menu or press ctrl+N.

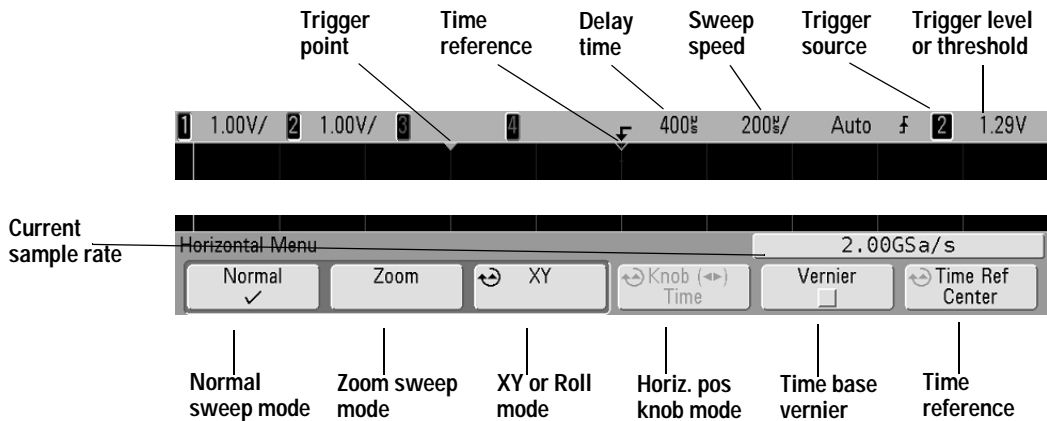

The Horizontal menu lets you select the horizontal mode (Normal, Zoom, XY, or Roll), and set the time base vernier and time reference.

The current sample rate is displayed above the **Vernier** and **Time Ref** softkeys.

Normal mode

- 1 Press the **Normal** softkey to select Normal horizontal mode.

Normal horizontal mode is the normal viewing mode for the oscilloscope. When the oscilloscope is stopped, you can use the Horizontal knobs to pan and zoom the waveform.

- 2 Turn the large knob (time/division) in the Horizontal section and notice the change it makes to the status line.

When the oscilloscope is running in Normal mode, use the large Horizontal knob to change sweep speed and use the small knob (◀▶) to set the horizontal position. When the oscilloscope is stopped, use these knobs to pan and zoom your waveform. The sweep speed (seconds/division) value is displayed in the status line.

- 3 Press the **Vernier** softkey to turn on the time base vernier.

The **Vernier** softkey lets you change the sweep speed in smaller increments with the time/division knob. The sweep speed remains fully calibrated when Vernier is on. The value is displayed in the status line at the top of the display.

When Vernier is turned off, the Horizontal sweep speed knob changes the time base sweep speed in a 1-2-5 step sequence.

- 4 Note the setting of the **Time Ref** (time reference) softkey.

Time reference is the reference point on the display for horizontal position (also called delay time). Time reference can be set to one major division from the left or right edge, or to the center of the display.

A small hollow triangle (∇) at the top of the display grid marks the position of the time reference. When horizontal position is set to zero, the trigger point indicator (▼) overlays the time reference indicator.

Turning the Horizontal sweep speed knob will expand or contract the waveform about the time reference point (∇). Turning the horizontal position (◀▶) knob in Normal mode will move the trigger point indicator (▼) to the left or right of the time reference point (∇).

The time reference position sets the initial position of the trigger event within acquisition memory and on the display, with delay (horizontal position) set to 0. The horizontal position setting sets the specific location of the trigger event with respect to the time reference position. The time reference setting affects the Zoom sweep as described in the following ways:

- When the horizontal mode is set to Normal, the horizontal position knob positions the normal sweep relative to the trigger. This delay is a fixed number. Changing this delay value does not affect the sweep speed.
 - When the horizontal mode is set to Zoom, the horizontal position knob controls the position of the Zoom sweep window inside the normal sweep display. This delay value is independent of sampling interval and sweep speed. Changing the delay does not affect the position of the normal window.
- 5 Turn the horizontal position knob (◀▶) and notice that its value is displayed in the status line.

The horizontal position knob moves the normal sweep horizontally, and it pauses at 0.00 s, mimicking a mechanical detent. Changing the horizontal position moves the sweep horizontally and indicates how far the trigger point (solid inverted triangle) is from the time reference point (hollow inverted triangle ▽). These reference points are indicated along the top of the display grid. The previous figure shows the trigger point with the delay time (horizontal position) set to 400 μ s. The delay time number tells you how far the time reference point is located from the trigger point. When delay time (horizontal position) is set to zero, the delay time indicator overlays the time reference indicator.

All events displayed left of the trigger point happened before the trigger occurred, and these events are called pre-trigger information. You will find this feature very useful because you can now see the events that led up to the trigger point. Everything to the right of the trigger point is called post-trigger information. The amount of delay range (pre-trigger and post-trigger information) available depends on the sweep speed selected and memory depth.

Zoom mode

Zoom sweep is an expanded version of normal sweep. When Zoom mode is selected, the display divides in half and the Zoom sweep  icon displays in the middle of the line at the top of the display. The top half of the display shows the normal sweep and the bottom half displays the Zoom sweep.

Zoom sweep is a magnified portion of the normal sweep. You can use Zoom sweep to locate and horizontally expand part of the normal sweep for a more detailed (higher-resolution) analysis of signals.

The following steps show you how to use Zoom sweep. Notice that the steps are very similar to operating the “delayed sweep” in analog oscilloscopes.

- 1 Connect a signal to the oscilloscope and obtain a stable display.
- 2 Press **Menu/Zoom**.
- 3 Press the **Zoom** softkey.

To change the sweep speed for the Zoom sweep window, turn the sweep speed knob. As you turn the knob, the sweep speed is highlighted in the status line above the waveform display area.

The area of the normal display that is expanded is intensified and marked on each end with a vertical marker. These markers show what portion of the normal sweep is expanded in the lower half. The Horizontal knobs control the size and position of the Zoom sweep. The delay value is momentarily displayed in the upper-right portion of the display when the horizontal position (◀▶) knob is turned.

To change the sweep speed for the normal sweep window, press the **Normal** softkey, then turn the sweep speed knob.

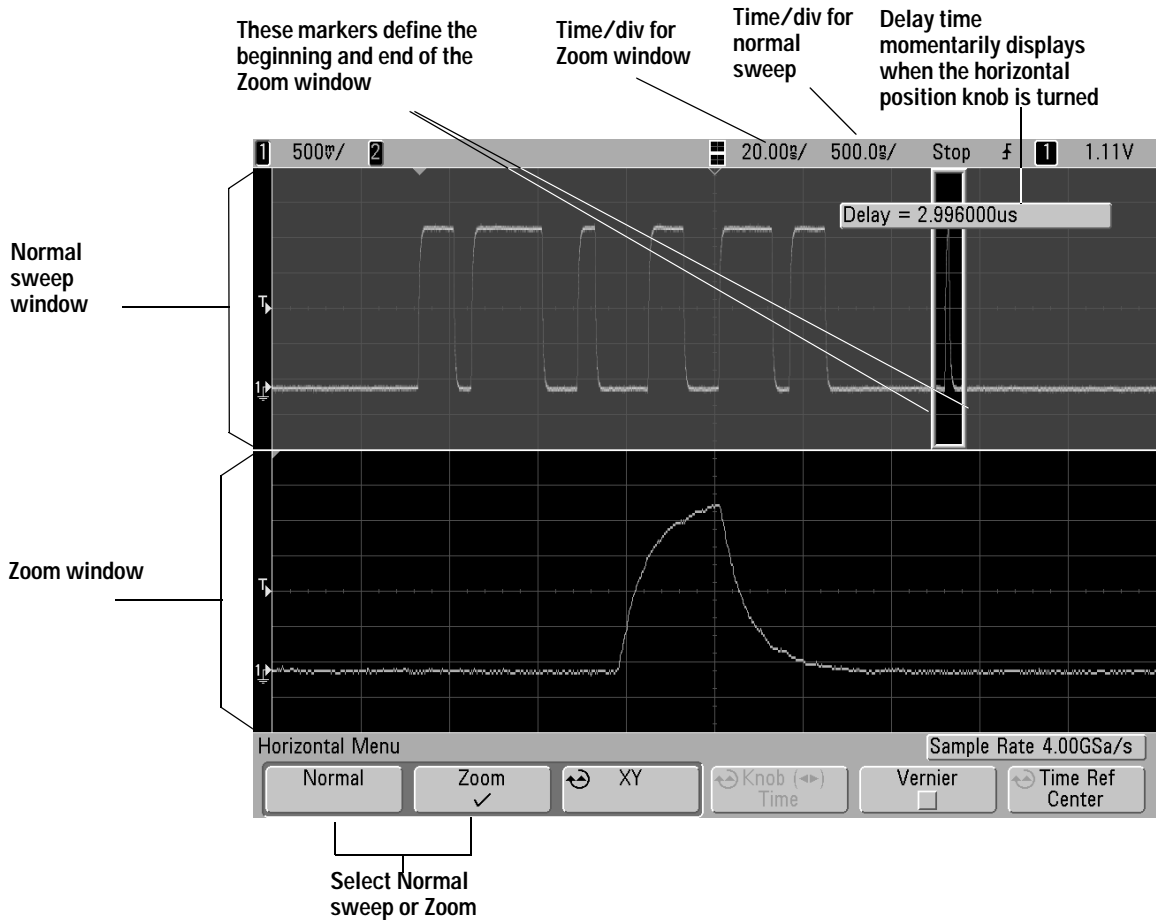

The area of the normal display that is expanded is intensified and marked on each end with a vertical marker. These markers show what portion of the normal sweep is expanded in the lower half. The Horizontal knobs control the size and position of the Zoom sweep. The delay value is momentarily displayed in the upper-right portion of the display when the horizontal position (◀▶) knob is turned.

To change the sweep speed for the Zoom sweep window, turn the sweep speed knob. As you turn the knob, the sweep speed is highlighted in the status line above the waveform display area.

The time reference position sets the initial position of the trigger event within acquisition memory and on the display, with delay (horizontal position) set to 0. The delay setting sets the specific location of the trigger event with respect to the time reference position. The time reference setting affects the Zoom sweep in the following ways.

When the horizontal mode is set to Normal, the horizontal position knob positions the normal sweep relative to the trigger. This delay is a fixed number. Changing this delay value does not affect the sweep speed. When the horizontal mode is set to Zoom, the delay controls the position of the Zoom sweep window inside the normal sweep display. This delay value is independent of sampling interval and sweep speed.

To change the sweep speed for the normal sweep window, press the **Normal** softkey, then turn the sweep speed knob.

For information about using Zoom mode for measurements, refer to Chapter 5, “Making Measurements,” starting on page 213.

Roll mode

- Press the **Menu/Zoom** key, then press the **XY** or **Roll** softkey to select “Roll”.
- Roll mode causes the waveform to move slowly across the screen from right to left. It only operates on time base settings of 500 ms/div and slower. If the current time base setting is faster than the 500 ms/div limit, it will be set to 500 ms/div when Roll mode is entered.
- In Normal horizontal mode, signal events occurring before the trigger are plotted to the left of the trigger point (t) and signal events after the trigger plotted to the right of the trigger point.

- In Roll mode there is no trigger. The fixed reference point on the screen is the right edge of the screen and refers to the current moment in time. Events that have occurred are scrolled to the left of the reference point. Since there is no trigger, no pre-trigger information is available.

If you would like to pause the display in Roll mode press the **Single** key. To clear the display and restart an acquisition in Roll mode, press the **Single** key again.

Use Roll mode on low-frequency waveforms to yield a display much like a strip chart recorder. It allows the waveform to roll across the display.

XY mode

XY mode changes the display from a volts-versus-time display to a volts-versus-volts display. The time base is turned off. Channel 1 amplitude is plotted on the X-axis and Channel 2 amplitude is plotted on the Y-axis.

You can use XY mode to compare frequency and phase relationships between two signals. XY mode can also be used with transducers to display strain versus displacement, flow versus pressure, volts versus current, or voltage versus frequency.

Use the cursors to make measurements on XY mode waveforms.

For more information about using XY mode for measurements, refer to “To use the XY horizontal mode” on page 214.

Knob softkey

The “Knob ◀▶” softkey is used in conjunction with Segmented Memory. You can set the Horizontal Position knob to adjust the horizontal position or move between segments. See “Using Serial Decode” on page 301.

Z-Axis Input in XY Display Mode (Blanking)

When you select the XY display mode, the time base is turned off. Channel 1 is the X-axis input, channel 2 is the Y-axis input, and channel 4 (or the External trigger on 2-channel models) is the Z-axis input. If you only want to see portions of the Y versus X display, use the Z-axis input. Z-axis turns the trace on and off (analog oscilloscopes called this Z-axis blanking because it turned the beam on and off). When Z is low (<1.4 V), Y versus X is displayed; when Z is high (>1.4 V), the trace is turned off.

To make cursor measurements

You can use the cursors to make custom voltage or time measurements on oscilloscope signals, and timing measurements on digital channels. Cursor information is displayed on the line above the softkeys.

Cursors are horizontal and vertical markers that indicate X-axis values (usually time) and Y-axis values (usually voltage) on a selected waveform source. The position of the cursors can be changed using the Entry knob.

- 1 Connect a signal to the oscilloscope and obtain a stable display.
- 2 Press the **Cursors** key (the key will illuminate, indicating that cursors are “on”). Use the softkeys in the Cursors menu to set up your measurement.
 - **Mode**
 - **Manual** – X, $1/\Delta X$, and ΔY values are displayed. Use the Entry knob and softkeys to change cursor positions.
 - **Track Waveform** – Y1 cursor tracks the waveform assigned to Source 1 as X1 is moved, and Y2 cursor tracks the waveform assigned to Source 2 as X2 is moved.
 - **Binary** – Logic levels of displayed waveforms at the current X1 and X2 cursor positions are displayed above the softkeys in binary. The display is color coded to match the color of the related channel’s waveform.

- **Hex** – Logic levels of displayed waveforms at the current X1 and X2 cursor positions are displayed above the softkeys in hexadecimal.
- In **Hex** and **Binary** modes, a level can be displayed as 1 (higher than trigger level), 0 (lower than trigger level), indeterminate state (), or X (don't care). In Binary mode, X is displayed if the channel is turned off. In Hex mode, the channel is interpreted as a low if turned off.
- **Source** – selects a channel or math function for the cursor measurements.
- **X Y** – Select either the X cursors or the Y cursors for adjustment with the Entry knob.
- **X1, X2** – adjust horizontally and normally measure time.
- **Y1, Y2** – adjust vertically and normally measure voltage.
- **X1 X2** or **Y1 Y2** – move the cursors together when turning the Entry knob.

NOTE

If you intend to make cursor measurements on a trace that you recall from memory, be sure to recall both setup and trace. See “To recall waveform trace and/or oscilloscope setup” on page 368.

For more information about using the cursors, see “To make cursor measurements” on page 238.

To make automatic measurements

You can use automatic measurements on any channel source or any running math function. Cursors are turned on to focus on the most recently selected measurement (right-most on the measurement line above the softkeys on the display).

- 1 Press the **Quick Meas** key to display the automatic measurement menu.

To manually control Quick Measurements on 6000L models start the Remote Front Panel (see page 49) and select **Measure** from the Main Menu or press ctrl+M to access the oscilloscope's Quick Measurements Menu.

- 2 Press the **Source** softkey to select the channel or running math function to be measured.

Only channels or math functions that are displayed are available for measurements. If you choose an invalid source channel for a measurement, the measurement will default to the nearest in the list that makes the source valid.

If a portion of the waveform required for a measurement is not displayed or does not display enough resolution to make the measurement, the result will be displayed with a message such as greater than a value, less than a value, not enough edges, not enough amplitude, incomplete, or waveform is clipped to indicate that the measurement may not be reliable.

- 3 Choose a type of measurement by pressing the **Select** softkey, then turn the Entry knob  to select the desired measurement from the popup list.
- 4 Press the **Measure** softkey to make the selected measurement. The measured value, mean, minimum, maximum, standard deviation, and count (number of times the measurement has been made) are displayed.
- 5 To stop making one or more measurements, press the **Clear Meas** softkey and choose the measurement to clear, or press **Clear All**.

For more information about automatic measurements, see “Automatic Measurements” on page 246.

Using Labels

You can define labels and assign them to each analog input channel, or you can turn labels off to increase the waveform display area. Labels can also be applied to digital channels on MSO models.

To turn the label display on or off

- 1 Press the **Label** key on the front panel.

This turns on display labels for the analog and digital channels. When the **Label** key is illuminated, the labels for displayed channels are displayed at the left edge of the displayed traces. The figure below shows an example of the default labels assigned when you turn the label display on. The channel labels default to their channel number.



- 2 To turn the labels off, press the **Label** key until it is not illuminated.

To assign a predefined label to a channel

- 1 Press the **Label** key.
- 2 Press the **Channel** softkey, then turn the Entry knob or successively press the **Channel** softkey to select a channel for label assignment.

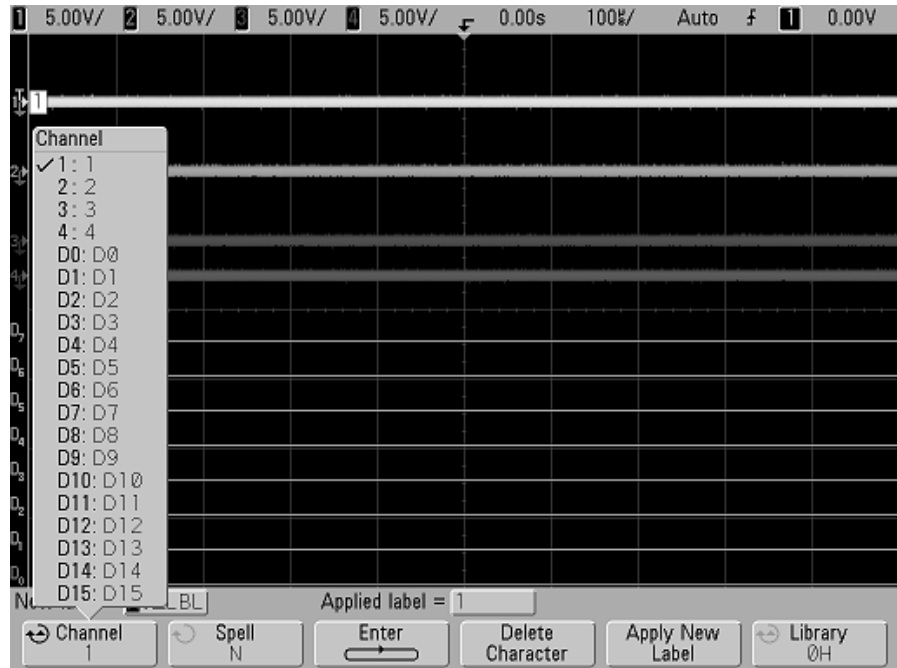

The figure above shows the list of channels and their default labels. The channel does not have to be turned on to have a label assigned to it.

- 3 Press the **Library** softkey, then turn the Entry knob or successively press the **Library** softkey to select a predefined label from the library.
- 4 Press the **Apply New Label** softkey to assign the label to your selected channel.
- 5 Repeat the above procedure for each predefined label you want to assign to a channel.

To define a new label

- 1 Press the **Label** key.
- 2 Press the **Channel** softkey, then turn the Entry knob or successively press the softkey to select a channel for label assignment.

The channel does not have to be turned on to have a label assigned to it. If the channel is turned on, its current label will be highlighted.

- 3 Press the **Spell** softkey, then turn the Entry knob to select the first character in the new label.

Turning the Entry knob selects a character to enter into the highlighted position shown in the "**New label =**" line above the softkeys and in the **Spell** softkey. Labels can be up to ten characters in length.

- 4 Press the **Enter** softkey to enter the selected character and to go to the next character position.

You may position the highlight on any character in the label name by successively pressing the **Enter** softkey.

- 5 To delete a character from the label, press the **Enter** softkey until the letter you want to delete is highlighted, then press the **Delete Character** softkey.
- 6 When you are done entering characters for the label, press the **Apply New Label** softkey to assign the label to the selected channel.

When you define a new label, it is added to the nonvolatile label list.

Label Assignment Auto-Increment Features

When you assign a label ending in a digit, such as ADDR0 or DATA0, the oscilloscope automatically increments the digit and displays the modified label in the "New label" field after you press the **Apply New Label** softkey. Therefore, you only need to select a new channel and press the **Apply New Label** softkey again to assign the label to the channel. Only the original label is saved in the label list. This feature makes it easier to assign successive labels to numbered control lines and data bus lines.

To load a list of labels from a text file you create

It may be convenient to create a list of labels using a text editor, then load the label list into the oscilloscope. This lets you type on a keyboard rather than edit the label list using the oscilloscope's controls.

You can create a list of up to 75 labels and load it into the oscilloscope. Labels are added to the beginning of the list. If more than 75 labels are loaded, only the first 75 are stored.

To load labels from a text file into the oscilloscope:

- 1 Use a text editor to create each label. Each label can be up to ten characters in length. Separate each label with a line feed.
- 2 Name the file `labellist.txt` and save it on a USB mass storage device such as a thumb drive.
- 3 Load the list into the oscilloscope using the File Explorer (press **Utility**→**File Explorer**).

Label List Management

When you press the **Library** softkey, you will see a list of the last 75 labels used. The list does not save duplicate labels. Labels can end in any number of trailing digits. As long as the base string is the same as an existing label in the library, the new label will not be put in the library. For example, if label A0 is in the library and you make a new label called A12345, the new label is not added to the library. When you save a new user-defined label, the new label will replace the oldest label in the list. Oldest is defined as the longest time since the label was last assigned to a channel. Any time you assign any label to a channel, that label will move to the newest in the list. Thus, after you use the label list for a while, your labels will predominate, making it easier to customize the instrument display for your needs.

When you reset the label library list (see next topic), all of your custom labels will be deleted, and the label list will be returned to its factory configuration.

To reset the label library to the factory default

- 1 Press **Utility&Options&Preferences**.

CAUTION

Pressing the Default Library softkey will remove all user-defined labels from the library and set the labels back to the factory default. Once deleted, these user-defined labels cannot be recovered.

- 2 Press the **Default Library** softkey.

This will delete all user-defined labels from the library and set the labels in the library back to the factory default.

However, this does not default the labels currently assigned to the channels (those labels that appear in the waveform area).

Defaulting labels without erasing the default library.

Selecting **Default Setup** in the **Save/Recall** menu will set all channel labels back to the default labels but does not erase the list of user-defined labels in the library.

To print the display

You can print the complete display, including the status line and softkeys, to a USB printer. Press the **Print** key (labeled **Quick Print** on older models), then press the **Press to Print** softkey. You can stop printing by pressing the **Cancel Print** softkey.

For more information on printing, see “Print options” on page 353.

To set the clock

The Clock menu lets you set the current date and time of day (24-hour format). This time/date stamp will appear on hardcopy prints and directory information on the USB mass storage device.

To set the date and time, or to view the current date and time:

- 1 Press **Utility&Options&Clock**.

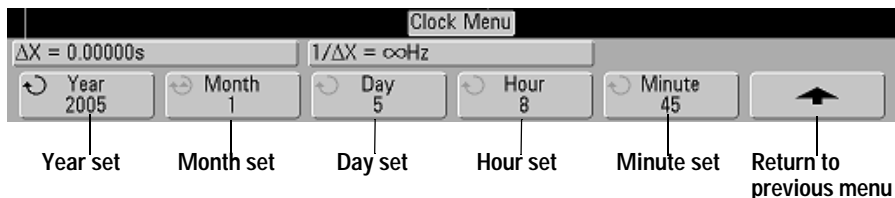

- 2 Press the **Year, Month, Day, Hour** or **Minute** softkey and rotate the Entry knob to set to the desired number.

The hours are shown in the 24-hour format. So 1:00 PM is hour 13.

The real-time clock only allows selection of valid dates. If a day is selected and the month or year is changed so the day is invalid, the day is automatically adjusted.

To set up the screen saver

NOTE

The Screen Saver is disabled on 6000L models.

The oscilloscope can be configured to turn on a display screen saver when the oscilloscope has been idle for a specified length of time.

- 1 Press **Utility&Options&Preferences&Screen Saver** to display the screen saver menu.

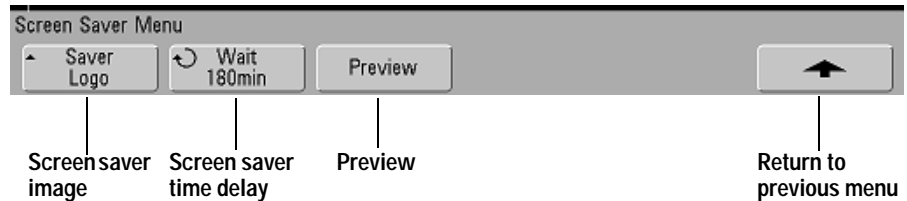

- 2 Press the **Saver** softkey to select the screen saver type.

The screen saver can be set to **Off**, to display any of the images shown in the list, or can display a user-defined text string.

If **User** is selected, press the **Spell** softkey to select the first character of the text string. Use the Entry knob to choose a character. Then press the **Enter** softkey to advance to the next character and repeat the process. The resultant string is displayed in the "**Text =**" line above the softkeys.

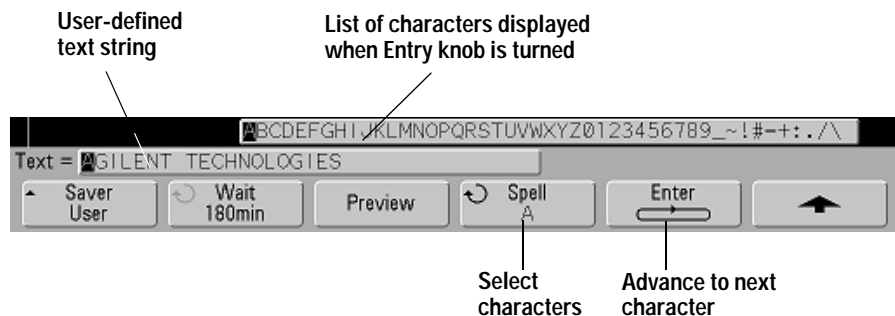

- 3 Turn the Entry knob to select the number of minutes to wait before the selected screen saver activates.

When you turn the Entry knob, the number of minutes is displayed in the **Wait** softkey. The default time is 180 minutes (3 hours).

- 4 Press the **Preview** softkey to preview the screen saver you have selected with the **Saver** softkey.
- 5 To view the normal display after the screen saver has started, press any key or turn any knob.

To set the waveform expansion reference point

- Press **Utility&Options&Preferences&Expand** and select **Ground** or **Center**.

When you change a channel's volts/division setting, the waveform display can be set to expand (or compress) about the signal ground level or the center of the display.

Expand About Ground The displayed waveform will expand about the position of the channel's ground. This is the default setting. The ground level of the signal is identified by the position of the ground level () icon at the far-left side of the display. The ground level will not move when you adjust the vertical sensitivity (volts/division) control.

If the ground level is off screen, the waveform will expand about the top or bottom edge of the screen based on where the ground is off screen.

Expand About Center The displayed waveform will expand about the center of the display.

To perform service functions

- Press the **Utility&Service** to display the service menu.

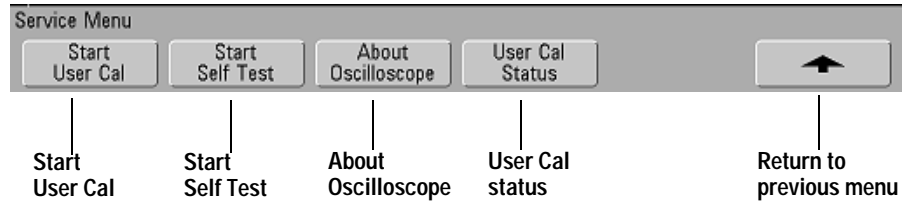

The Service Menu lets you:

- Perform User Cal on the oscilloscope.
- View User Cal status.
- Perform instrument Self Test.
- View information about your oscilloscope model number, code revision information, and User Cal status.

User Calibration

Perform user-calibration:

- Each year or after 2000 hours of operation.
- If the ambient temperature is $>10^{\circ}$ C from the calibration temperature.
- If you want to maximize the measurement accuracy.

The amount of use, environmental conditions, and experience with other instruments help determine if you need shorter User Cal intervals.

User Cal performs an internal self-alignment routine to optimize the signal path in the oscilloscope. The routine uses internally generated signals to optimize circuits that affect channel sensitivity, offset, and trigger parameters. Disconnect all inputs and allow the oscilloscope to warm up before performing this procedure.

Performing User Cal will invalidate your Certificate of Calibration. If NIST (National Institute of Standards and Technology) traceability is required, perform the Performance Verification procedure in the *Agilent InfiniiVision 6000 Series Oscilloscopes Service Guide* using traceable sources.

To perform User Cal

- 1 Set the rear-panel CALIBRATION switch to UNPROTECTED.
- 2 Connect short (12 inch maximum) equal length cables to each analog channel's BNC connector on the front of the oscilloscope. You will need two equal-length cables for a 2-channel oscilloscope or four equal-length cables for a 4-channel oscilloscope.

Use 50Ω RG58AU or equivalent BNC cables when performing User Cal.

For a 2-channel oscilloscope, connect a BNC tee to the equal length cables. Then connect a BNC(f)-to-BNC(f) (also called a barrel connector) to the tee as shown below.

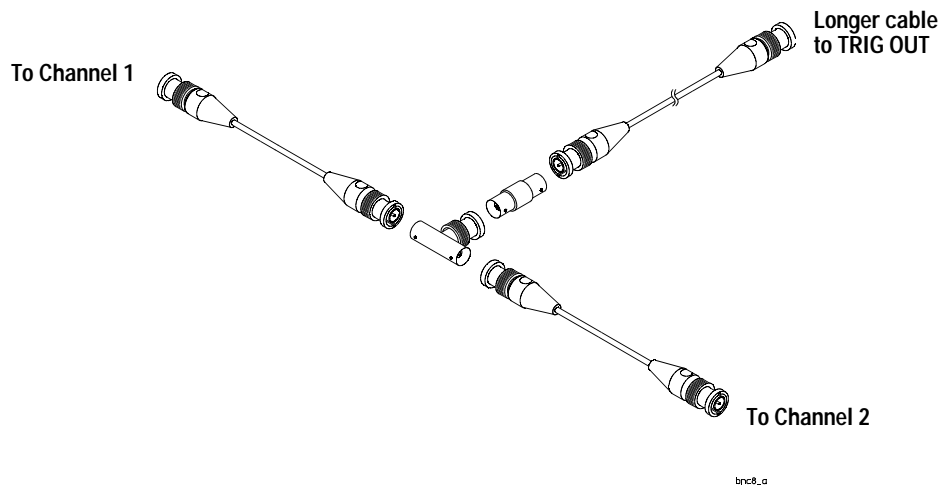

Figure 13 User Calibration cable for 2-channel oscilloscope

For a 4-channel oscilloscope, connect BNC tees to the equal-length cables as shown below. Then connect a BNC(f)-to-BNC(f) (barrel connector) to the tee as shown below.

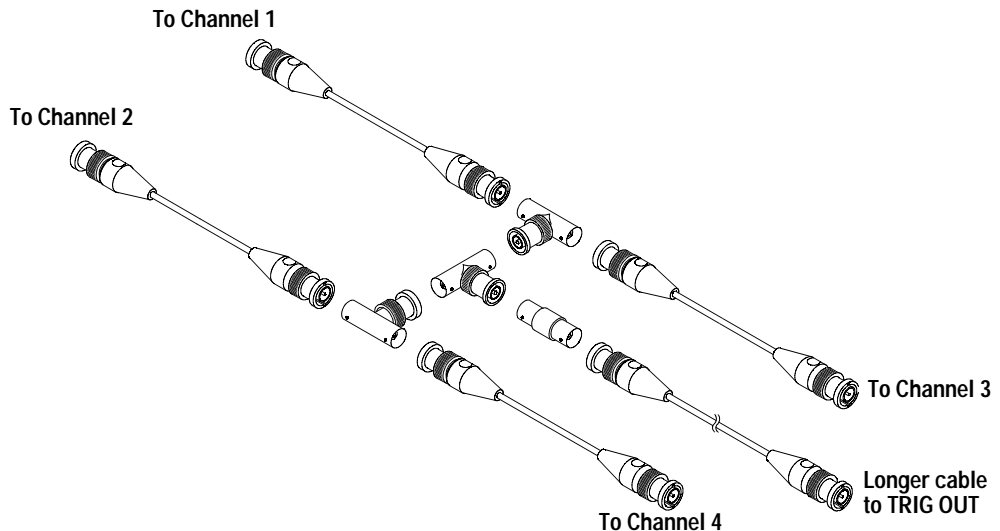

Figure 14 User Calibration cable for 4-channel oscilloscope

- 1 Connect a BNC cable (40 inches maximum) from the TRIG OUT connector on the rear panel to the BNC barrel connector.
- 2 Press the **Utility** key, then press the **Service** softkey.
- 3 Begin the Self Cal by pressing the **Start User Cal** softkey.
- 4 When the User Cal is completed, set the rear-panel CALIBRATION switch to PROTECTED.

User Cal Status

Pressing **Utility&Service&User Cal Status** displays the summary results of the previous User Cal, and the status of probe calibrations for probes that can be calibrated. Note that passive

probes do not need to be calibrated, but InfiniiMax probes can be calibrated. For more information about calibrating probes see page 60.

Results:

User Cal date:

Change in temperature since last User Cal:

Failure:

Comments:

Probe Cal Status:

Self Test

Pressing **Utility&Service&Start Self Test** performs a series of internal procedures to verify that the oscilloscope is operating properly.

It is recommended you run Self Test:

- after experiencing abnormal operation.
- for additional information to better describe an oscilloscope failure.
- to verify proper operation after the oscilloscope has been repaired.

Successfully passing Self Test does not guarantee 100% of the oscilloscope's functionality. Self Test is designed to provide an 80% confidence level that the oscilloscope is operating properly.

About Oscilloscope

Pressing **Utility&Service&About Oscilloscope** displays information about your oscilloscope model number, serial number, software version, boot version, graphics version, and installed licenses.

Installed licenses:

This line in the About Oscilloscope dialog contains information about the licenses that have been installed on the oscilloscope. For example, it can show:

- **232** – UART (Universal Asynchronous Receiver/Transmitter) and RS232 (Recommended Standard 232) trigger and decode. This license provides trigger and decode capability for many UART protocols including RS232.
- **ALT** – Altera FPGA Dynamic Probe. This license provides internal FPGA visibility and quick instrument setup.
- **AMS** – Automotive Serial Decode. This license provides serial decode of CAN and LIN buses.
- **BAT** – Battery power option. This license is only available at time of purchase. It can not be retrofitted.
- **FPG** – Xilinx FPGA Dynamic Probe. This license provides internal FPGA visibility and quick instrument setup.
- **FRS** – FlexRay Serial Decode. This license provides serial decode of FlexRay buses.
- **LSS** – Low Speed Serial Decode. This license provides serial decode of I²C and SPI buses.
- **memXM** – Memory Upgrade. This license provides additional memory depth up to 2 Mpts (mem2M) or 8 Mpts (mem8M) interleaved. 8 Mpts is standard on newer models.
- **MSO** – Mixed Signal Oscilloscope. This license adds 16 digital channels. You do not have to install any hardware. A digital probe cable is provided for connection to your device under test.
- **PWR** – This license lets your oscilloscope communicate with software running on a PC for characterizing power devices.
- **SEC** – Secure Environment mode. This feature prevents oscilloscope setup and trace information from being stored in the oscilloscope's internal memory.
- **SGM** – Segmented memory. This feature lets you capture infrequent or burst signals with great resolution by eliminating the capture of your signal's "dead time."
- **LMT** – Mask Limit Test. This license lets you create a mask and test waveforms to determine whether they comply to the mask.

To restore the oscilloscope to its default configuration

- Press the **Save/Recall** key, then press the **Default Setup** softkey.

The default configuration returns the oscilloscope to its default settings. This places the oscilloscope in a known operating condition. The major default settings are:

Horizontal normal mode, 100 $\mu\text{s}/\text{div}$ scale, 0 s delay, center time reference.

Vertical (Analog) Channel 1 on, 5 V/div scale, DC coupling, 0 V position, 1 M Ω impedance, probe factor to 1.0 if an AutoProbe probe is not connected to the channel.

Trigger Edge trigger, Auto sweep mode, 0 V level, channel 1 source, DC coupling, rising edge slope, 60 ns holdoff time.

Display Vectors on, 33% grid intensity, infinite persistence off.

Other Acquire mode normal, Run/Stop to Run, cursors and measurements off.

Labels All custom labels that you have created in the Label Library are preserved (not erased), but all channel labels will be set to their original names.

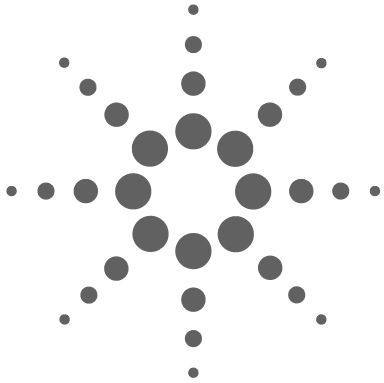

3

Viewing and Measuring Digital Signals

- To connect the digital probes to the circuit under test 120
- Acquiring waveforms using the digital channels 123
 - To display digital channels using AutoScale 124
- Interpreting the digital waveform display 126
 - To switch all digital channels on or off 127
 - To switch groups of channels on or off 127
 - To switch a single channel on or off 127
 - To change the displayed size of the digital channels 128
 - To reposition a digital channel 128
 - To change the logic threshold for digital channels 129
 - To display digital channels as a bus 130



To connect the digital probes to the circuit under test

The digital channels are enabled on MSO6000 models and DSO6000 models which have the MSO upgrade license installed.

- 1 If you feel it's necessary, turn off the power supply to the circuit under test.

Turning off power to the circuit under test would only prevent damage that might occur if you accidentally short two lines together while connecting probes. You can leave the oscilloscope powered on because no voltage appears at the probes.

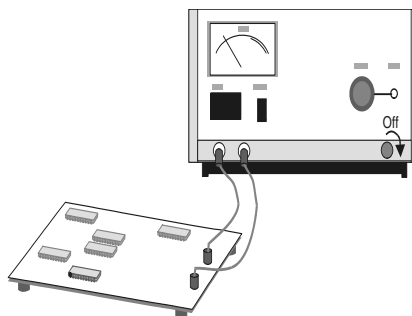

- 2 Connect the digital probe cable to the D15 - D0 connector on the rear panel of the mixed-signal oscilloscope. The digital probe cable is indexed so you can connect it only one way. You do not need to power-off the oscilloscope.

CAUTION



Use only Agilent digital probe cable

Use only the Agilent part number 54620-68701 digital probe kit supplied with the mixed-signal oscilloscope.

- 3 Route the cable under the oscilloscope and bring it out in front. Lay the two sections of the digital cable on top of each other at the front of the oscilloscope. Slip the narrow end of the cable guide over the cable and into its slots at the front of

the oscilloscope. Snap the wide end of the cable guide in place, being careful not to pinch the cable.

- 4 Connect the ground lead on each set of channels (each pod), using a probe grabber. The ground lead improves signal fidelity to the oscilloscope, ensuring accurate measurements.

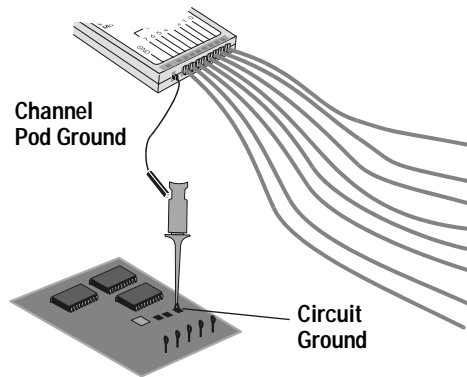

- 5 Connect a grabber to one of the probe leads. (Other probe leads are omitted from the figure for clarity.)

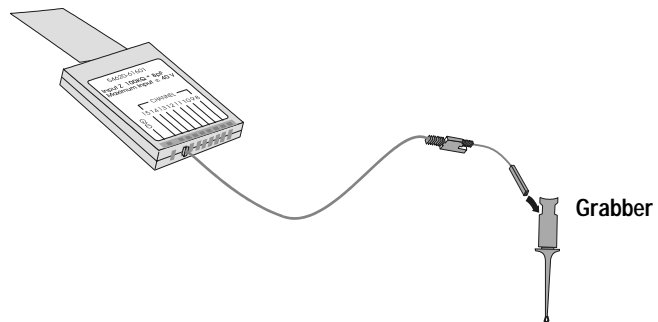

6 Connect the grabber to a node in the circuit you want to test.

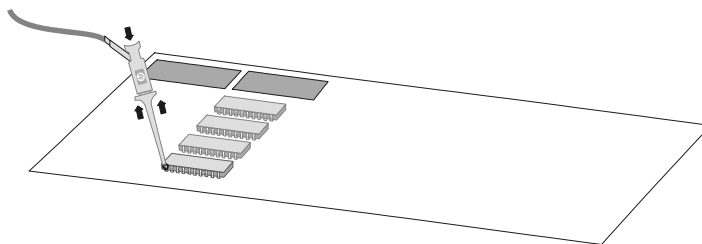

7 For high-speed signals, connect a ground lead to the probe lead, connect a grabber to the ground lead, and attach the grabber to ground in the circuit under test.

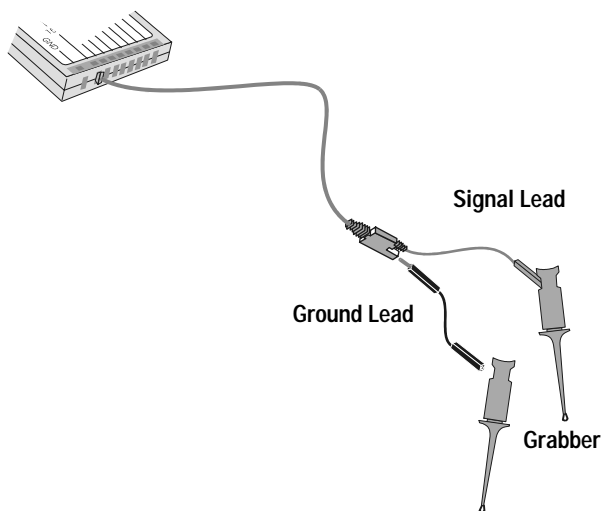

- Repeat steps 3 through 6 until you have connected all points of interest.

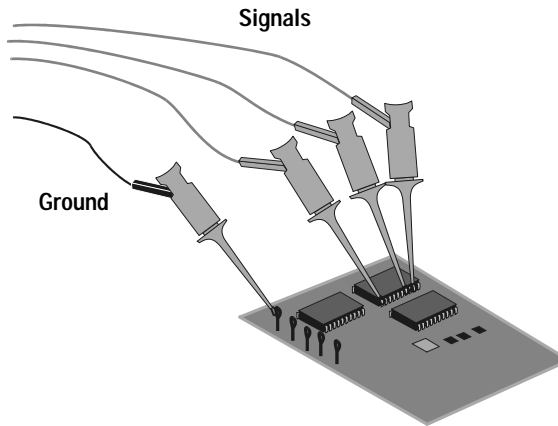

Acquiring waveforms using the digital channels

When you press Run/Stop or Single to run the oscilloscope, the oscilloscope examines the input voltage at each input probe. When the trigger conditions are met the oscilloscope triggers and displays the acquisition.

For digital channels, each time the oscilloscope takes a sample it compares the input voltage to the logic threshold. If the voltage is above the threshold, the oscilloscope stores a 1 in sample memory; otherwise, it stores a 0.

To display digital channels using AutoScale

When signals are connected to the digital channels, AutoScale quickly configures and displays the digital channels.

- To configure the instrument quickly, press the **AutoScale** key.

Any digital channel with an active signal will be displayed. Any digital channels without active signals will be turned off.

- To undo the effects of AutoScale, press the **Undo AutoScale** softkey before pressing any other key.

This is useful if you have unintentionally pressed the **AutoScale** key or do not like the settings AutoScale has selected. This will return the oscilloscope to its previous settings.

For information about how AutoScale works, see page 348.

To set the instrument to the factory-default configuration, press the **Save/Recall** key, then press the **Default Setup** softkey.

Example

Install probe clips on channels 0 and 1 of the digital probe cable. Connect the probes for digital channels 0 and 1 to the Probe Comp output on the front panel of the instrument. Be sure to connect the ground lead to the ground lug beside the Probe Comp output. Set the instrument to the factory default

configuration by pressing the **Save/Recall** key, then the **Default Setup** softkey. Then press the **AutoScale** key. You should see a display similar to the following.



Figure 15 AutoScale of digital channels 0 & 1 (MSO models only)

Interpreting the digital waveform display

The following figure shows a typical display with digital channels.

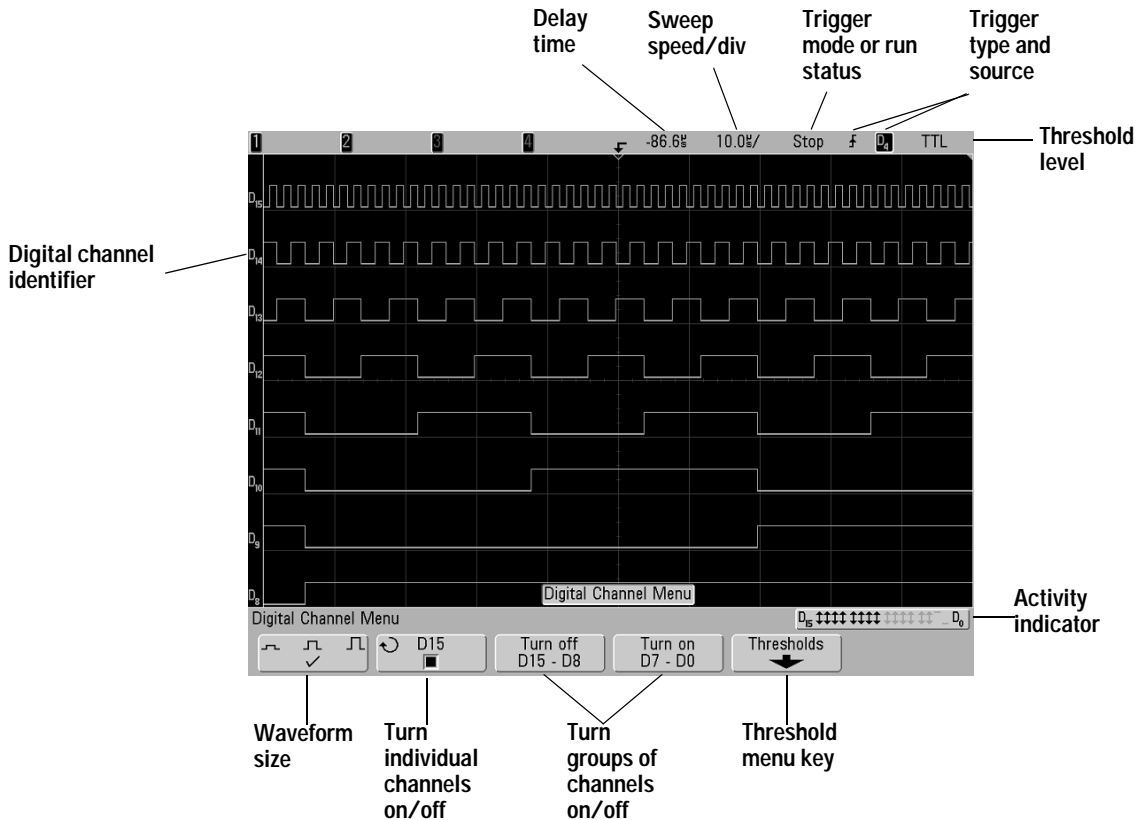

Activity indicator

When any digital channels are turned on, an activity indicator is displayed in the status line at the bottom of the display. A digital channel can be always high (■), always low (■), or actively toggling logic states (↑↓). Any channel that is turned off will be grayed out in the activity indicator.

To switch all digital channels on or off

- 1 Press the **D15 Thru D0** key to switch the display of the digital channels on or off. The Digital Channel Menu will be displayed above the softkeys.

On 6000L models select **Digital** from the main menu or press ctrl+D.

The digital channels are displayed when this key on the 6000A models is illuminated.

If you want to switch the digital channels off, and the Digital Channel Menu is not already displayed, you will have to push the **D15 Thru D0** key twice to switch the digital channels off. The first push displays the Digital Channel Menu, and the second push switches the channels off.

To switch groups of channels on or off



- 1 Press the **D15 Thru D0** key on the front panel if the Digital Channel Menu is not already displayed.
- 2 Press the **Turn off** (or **Turn on**) softkey for the **D15 - D8** group or the **D7 - D0** group.

Each time you press the softkey, the softkey's mode toggles between **Turn on** and **Turn off**.

To switch a single channel on or off

- 1 With the Digital Channel Menu displayed, rotate the Entry knob to select the desired channel from the popup menu.
- 2 Press the softkey that is directly below the popup menu to switch the selected channel on or off.

To change the displayed size of the digital channels

- 1 Press the **D15 Thru D0** key.
- 2 Press the size (  ) softkey to select how the digital channels are displayed.

The sizing control lets you spread out or compress the digital traces vertically on the display for more convenient viewing.

To reposition a digital channel

- 1 The **Digital Select** key is located on the front panel, just to the right of the display. Press either the up symbol or the down symbol on the **Digital Select** key () to select the channel you want to move. The selected channel is highlighted in red.



The “select” feature can also be used to highlight one of the digital channels for easy viewing.

- 2 Press either the up symbol or the down symbol on the **Digital Position** key, which is located below the **Digital Select** and **D15 Thru D0** keys. This moves the displayed channel up or down.

When two or more channels are displayed at the same vertical position, the channel label will be **D***. When you select this position, a pop up will appear showing a list of the overlaid channels. Use the **Digital Select** key to select the desired channel within the pop up. The selected channel will be highlighted in red.

If Labels are turned on, the label of the highlighted signal will appear on top. If none of the signals are highlighted, you will see a bus symbol with a number that indicates how many signals are overlapped.

You can move several channels to a single position to bus several signals together on the display.

Note that the **Digital Select** key () is different from the Entry knob (). The **Digital Select** key is only used to highlight (select) a digital channel for repositioning. The Entry knob's

function changes depending on which menu is displayed. For example, when assigning Labels on digital channels the Entry knob selects the channel to which the Label will be applied.

To change the logic threshold for digital channels

- 1 Press the **D15 Thru D0** key so that the Digital Channel Menu is displayed.
- 2 Press the **Thresholds** softkey
- 3 Press the **D15 - D8** or **D7 - D0** softkey, then select a logic family preset or select **User** to define your own threshold.

Logic family	Threshold Voltage
TTL	+1.4 V
CMOS	+2.5 V
ECL	-1.3 V
User	Variable from -8 V to +8 V

To change the logic threshold for digital channels 129set applies to all channels within the selected **D15 Thru D8** or **D7 Thru D0** group. Each of the two channel groups can be set to a different threshold if desired.

Values greater than the set threshold are high (H) and values less than the set threshold are low (L).

If the **Thresholds** softkey is set to **User**, press the **User** softkey for the channel group, then turn the Entry knob to set the logic threshold. There is one **User** softkey for each group of channels.

For advanced information see “Digital channel signal fidelity: Probe impedance and grounding” on page 382.

For information about replacement parts for the digital probe, see page 387.

To display digital channels as a bus

Digital channels may be grouped and displayed as a bus, with each bus value displayed at the bottom of the display in hex or binary. You can create up to two busses. To configure and display each bus, press the **D15 Thru D0** key on the front panel (just to the right of the display). Then press the **Bus** softkey.

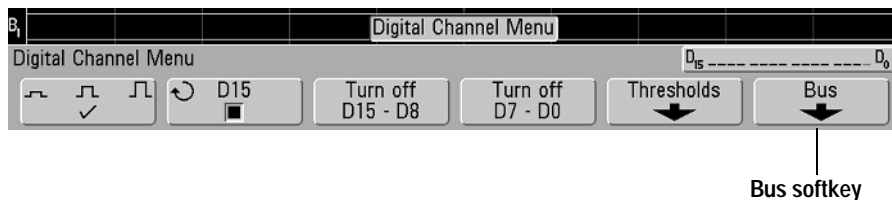

Next, select a bus by rotating the Entry knob, then press the **Bus1/Bus2** softkey to switch it on.

Use the softkey to the right and the Entry knob to select individual channels to be included in the bus. You can also press the **Select/Deselect D15-D8** and **Select/Deselect D7-D0** softkeys to include or exclude groups of eight channels in each bus.

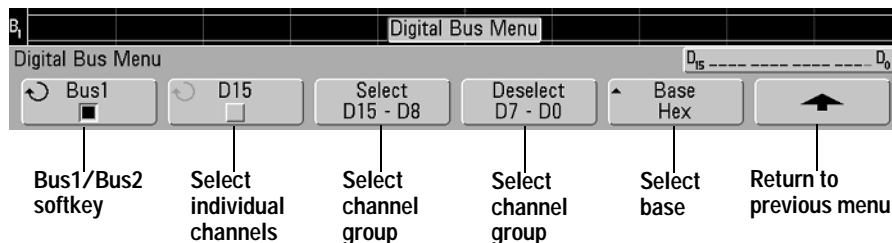

If the bus display is blank, completely white, or if the display includes "...", you need to expand the horizontal scale to allow space for the data to be shown, or use the cursors to display the values (see page 131).

The **Base** softkey lets you choose to display the bus values in hex or binary.

The buses are shown at the bottom of the display.

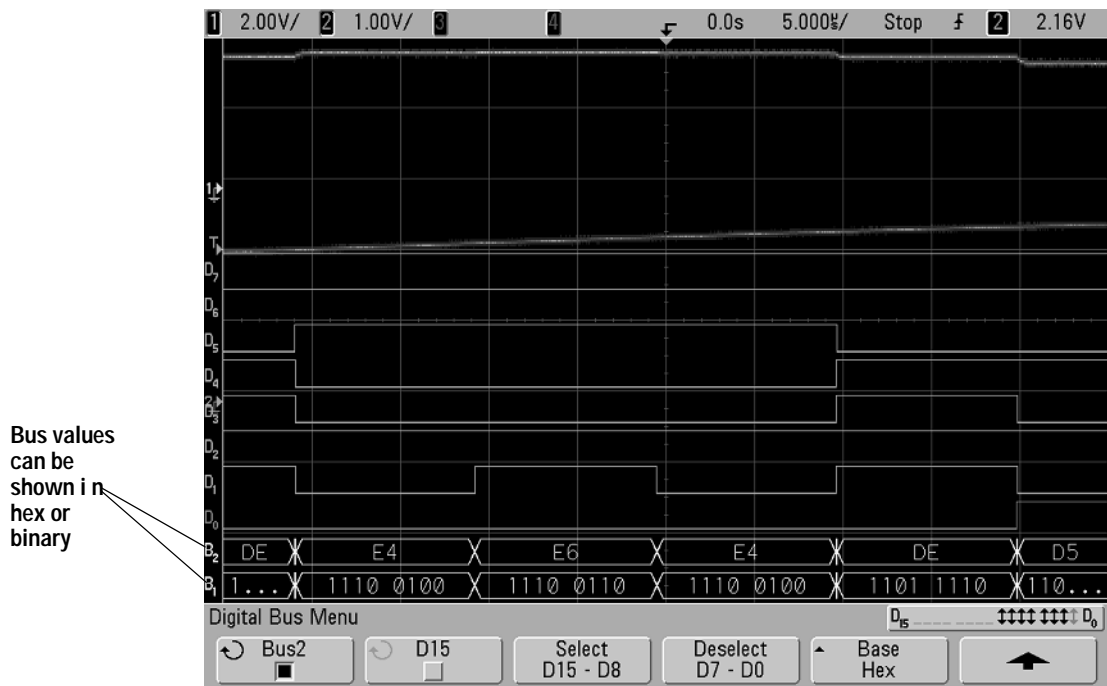

Using cursors to read bus values

To read the digital bus value at any point using the cursors:

- 1 Switch on Cursors (by pressing the **Cursor** key on the front panel)
- 2 Press the cursor **Mode** softkey and change the mode to **Hex** or **Binary**.
- 3 Press the **Source** softkey and select **Bus1** or **Bus2**.

3 Viewing and Measuring Digital Signals

4 Use the Entry knob and the X1 and X2 softkeys to position the cursors where you want to read the bus values.

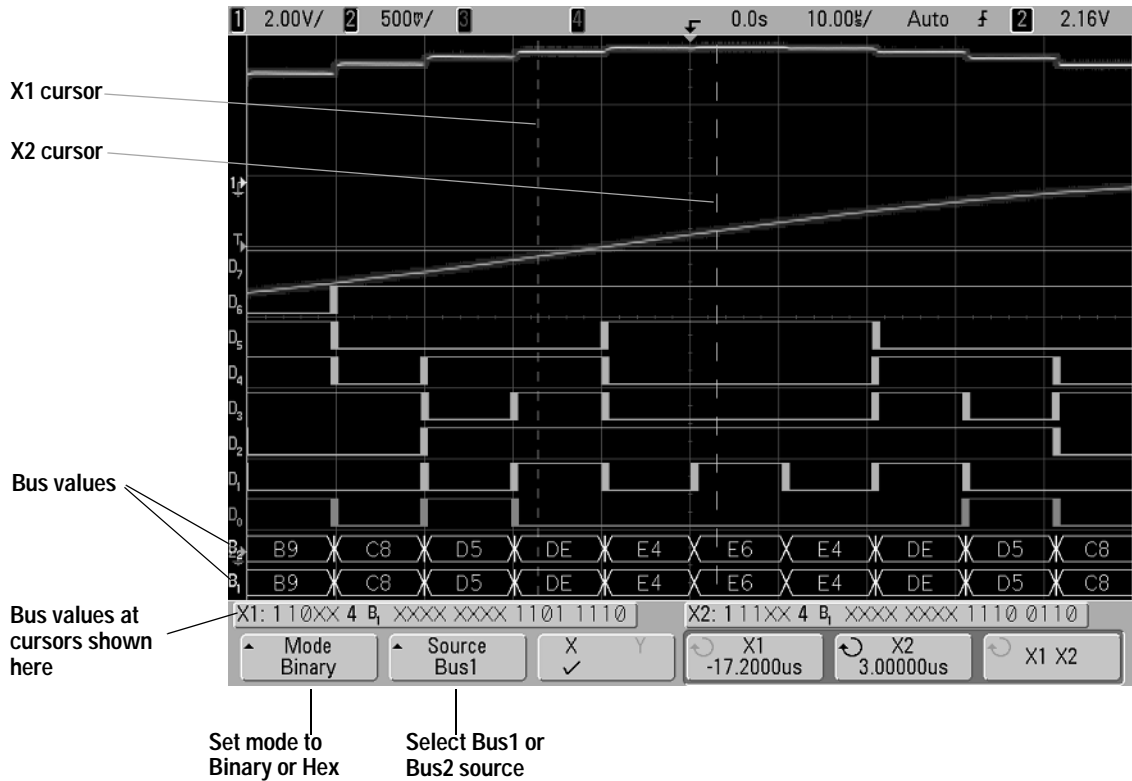

When you press the D15 Thru D0 key to display the Digital Channel Menu, the digital activity indicator is shown where the cursor values were and the bus values at the cursors are displayed in the graticule.

Bus values are displayed when using Pattern trigger

The bus values are also displayed when using the Pattern trigger function. Press the **Pattern** key on the front panel to display the Pattern Trigger Menu and the bus values will be displayed on the right, above the softkeys.

The dollar sign (\$) will be displayed in the bus value when the bus value can not be displayed as a hex value. This occurs when one or more “don’t cares” (X) are combined with high (H) and low (L) logic levels in the pattern specification, or when a transition indicator (rising edge (↑) or falling edge (↓)) are included in the pattern specification. A byte that consists of all don’t cares (X) will be displayed in the bus as a don’t care (X).

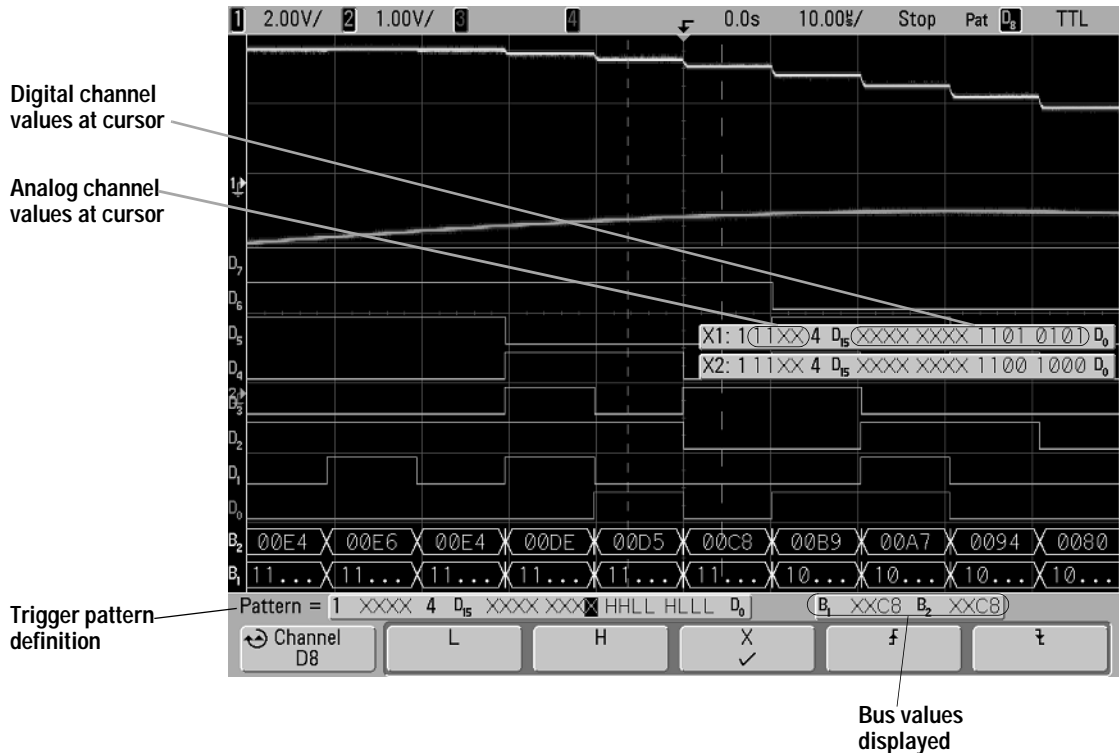

See page 153 for more information on Pattern triggering.

3 Viewing and Measuring Digital Signals

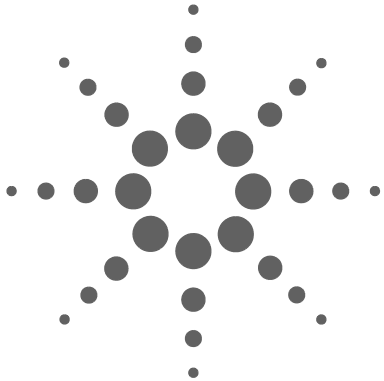

4 Triggering the Oscilloscope

Selecting Trigger Modes and Conditions	138
The External Trigger input	144
Trigger Types	147
To use Edge triggering	148
To use Pulse Width triggering	150
To use Pattern triggering	153
To use CAN triggering	156
To use Duration triggering	161
To use I2C triggering	169
To use Nth Edge Burst triggering	175
To use LIN triggering	177
To use Sequence triggering	181
To use SPI triggering	188
To use TV triggering	193
To use UART/RS232 triggering	205
To use USB triggering	210
To use FlexRay triggering	164
The Trigger Out connector	212



The Agilent InfiniiVision 6000 Series oscilloscopes provide a full set of features to help automate your measurement tasks. MegaZoom technology lets you capture and examine untriggered waveforms. With these oscilloscopes you can:

- Modify the way the oscilloscope acquires data.
- Set up simple or complex trigger conditions as needed, to capture only the sequence of events you want to examine.

Triggering Features

- Trigger modes:
 - Auto
 - Normal
 - Coupling (DC, AC, low frequency rejection)
 - Noise rejection
 - High frequency rejection
- Holdoff
- Trigger Level
- External Trigger input
- Trigger types:
 - Edge (slope)
 - Pulse width (glitch)
 - Pattern
 - CAN
 - Duration
 - FlexRay
 - I²C
 - Nth Edge Burst
 - LIN
 - Sequence
 - SPI
 - TV
 - USB

- Trigger Out connector

NOTE

Adding options such as the Low Speed Serial (LSS) or Automotive Serial (AMS) serial decode feature to the oscilloscope will add more trigger features to the relevant trigger types (I²C and SPI, or CAN and LIN). Adding option FRS (FlexRay serial decode) will add FlexRay to the trigger types. See “Using Serial Decode” on page 301 for more information.

To manually control Triggering on 6000L models start the Remote Front Panel (see page 49) and select **Trigger** from the Main Menu.

Selecting Trigger Modes and Conditions

The trigger mode affects the way in which the oscilloscope searches for the trigger. The figure below shows the conceptual representation of acquisition memory. Think of the trigger event as dividing acquisition memory into a pre-trigger and post-trigger buffer. The position of the trigger event in acquisition memory is defined by the time reference point and the delay (horizontal position) setting.

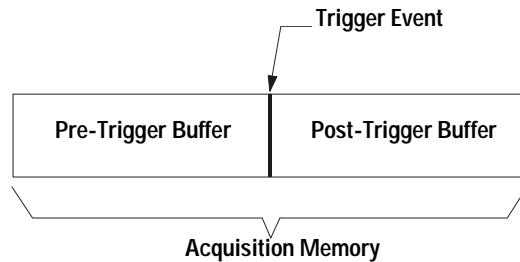
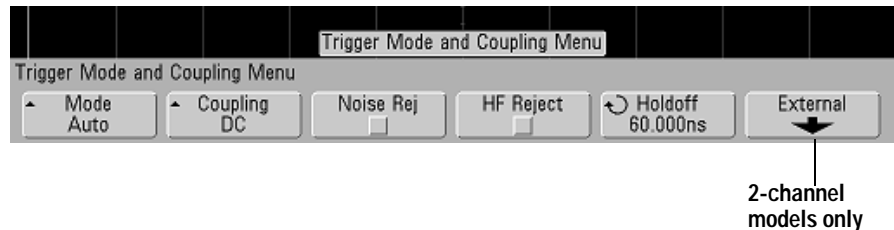

Figure 16 Acquisition Memory

To select the Mode and Coupling menu

- Press the **Mode/Coupling** key in the Trigger section of the front panel.



Trigger modes: Normal and Auto

An introduction to Normal and Auto trigger modes is given on page 87.

- 1 Press the **Mode/Coupling** key.
- 2 Press the **Mode** softkey, then select **Normal** or **Auto**.
 - **Normal** mode displays a waveform when the trigger conditions are met, otherwise the oscilloscope does not trigger and the display is not updated.
 - **Auto** mode is the same as Normal mode, except it forces the oscilloscope to trigger if the trigger conditions are not met.

Auto mode

Use the auto trigger modes for signals other than low-repetitive-rate signals and for unknown signal levels. To display a DC signal, you must use auto trigger mode since there are no edges on which to trigger.

When you select **Run**, the oscilloscope operates by first filling the pre-trigger buffer. It starts searching for a trigger after the pre-trigger buffer is filled, and continues to flow data through this buffer while it searches for the trigger. While searching for the trigger, the oscilloscope overflows the pre-trigger buffer; the first data put into the buffer is the first pushed out (FIFO). When a trigger is found, the pre-trigger buffer will contain the events that occurred just before the trigger. If no trigger is found, the oscilloscope generates a trigger and displays the data as though a trigger had occurred. In this case, the background of the **Auto** indicator at the top of the display will flash, and the **Auto** indicator will change to **Auto?** indicating that the oscilloscope is forcing triggers.

When you press the **Single** key, the oscilloscope will fill pre-trigger buffer memory, and continue flowing data through the pre-trigger buffer until the auto trigger overrides the searching and forces a trigger. At the end of the trace, the oscilloscope will stop and display the results.

Normal mode

Use Normal trigger mode for low repetitive-rate signals or when Auto trigger is not required.

In Normal mode the oscilloscope must fill the pre-trigger buffer with data before it will begin searching for a trigger event. The trigger mode indicator on the status line flashes **Trig'd?** to indicate the oscilloscope is filling the pre-trigger buffer. While searching for the trigger, the oscilloscope overflows the pre-trigger buffer; the first data put into the buffer is the first pushed out (FIFO).

When the trigger event is found, the oscilloscope will fill the post-trigger buffer and display the acquisition memory. The trigger mode indicator on the status line indicates **Trig'd** (not flashing). If the acquisition was initiated by **Run/Stop**, the process repeats. If the acquisition was initiated by pressing **Single**, then the acquisition stops and you can Pan and Zoom the waveform.

In either Auto or Normal mode, the trigger may be missed completely under certain conditions. This is because the oscilloscope will not recognize a trigger event until the pre-trigger buffer is full. Suppose you set the Time/Div knob to a slow sweep speed, such as 500 ms/div. If the trigger condition occurs before the oscilloscope has filled the pre-trigger buffer, the trigger will not be found. If you use Normal mode and wait for the trigger condition indicator to flash before causing the action in the circuit, the oscilloscope will always find the trigger condition.

Some measurements you want to make will require you to take some action in the circuit under test to cause the trigger event. Usually, these are single-shot acquisitions, where you will use the **Single** key.

To select trigger Coupling

- 1 Press the **Mode/Coupling** key.
- 2 Press the **Coupling** softkey, then select **DC**, **AC**, or **LF Reject** coupling.
 - **DC** coupling allows DC and AC signals into the trigger path.
 - **AC** coupling places a 10 Hz (3.5 Hz in 100 MHz bandwidth models) high-pass filter in the trigger path removing any DC offset voltage from the trigger waveform. The high-pass filter in the External Trigger input path is 3.5 Hz for all models. Use AC coupling to get a stable edge trigger when your waveform has a large DC offset.
 - **LF (low frequency) Reject** coupling places a 50 kHz high-pass filter in series with the trigger waveform. Low frequency reject removes any unwanted low frequency components from a trigger waveform, such as power line frequencies, that can interfere with proper triggering. Use this coupling to get a stable edge trigger when your waveform has low frequency noise.
 - **TV** coupling is normally grayed-out, but is automatically selected when TV trigger is enabled in the Trigger More menu.

Note that Trigger Coupling is independent of Channel Coupling. To change Channel Coupling see page 92.

To select trigger Noise Rejection and HF rejection

- 1 Press the **Mode/Coupling** key.
- 2 Press the **Noise Rej** softkey to select noise reject or press the **HF Reject** softkey to select high frequency reject.
 - **Noise Rej** adds additional hysteresis to the trigger circuitry. When noise reject is on, the trigger circuitry is less sensitive to noise but may require a greater amplitude waveform to trigger the oscilloscope.

- **HF Reject** adds a 50 kHz low-pass filter in the trigger path to remove high frequency components from the trigger waveform. You can use HF Reject to remove high-frequency noise, such as AM or FM broadcast stations or noise from fast system clocks, from the trigger path.

To set Holdoff

- 1 Press the **Mode/Coupling** key.
- 2 Turn the Entry knob  to increase or decrease the trigger holdoff time shown in the **Holdoff** softkey.

Holdoff sets the amount of time that the oscilloscope waits before re-arming the trigger circuitry. Use Holdoff to stabilize the display of complex waveforms.

To get a stable trigger on the pulse burst shown below, set the holdoff time to be >200 ns but <600 ns.

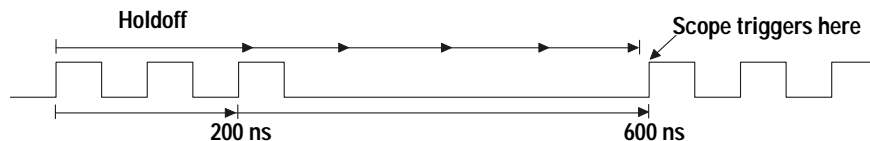

By setting the Holdoff, you can synchronize triggers. The oscilloscope will trigger on one edge of the waveform, and ignore further edges until the holdoff time expires. The oscilloscope will then re-arm the trigger circuit to search for the next edge trigger. This allows the oscilloscope to trigger on a repeating pattern in a waveform.

Holdoff Operating Hints

Holdoff keeps a trigger from occurring until after a certain amount of time has passed since the last trigger. This feature is valuable when a waveform crosses the trigger level multiple times during one period of the waveform.

Without holdoff, the oscilloscope could trigger on each of the crossings, producing a confusing waveform. With holdoff set correctly, the oscilloscope always triggers on the same crossing. The correct holdoff setting is typically slightly less than one period. Set the holdoff to this time to generate a unique trigger point. This action works even though many waveform periods pass between triggers, because the holdoff circuit operates on the input signal continuously.

Changing the time base settings does not affect the holdoff number. In contrast, the holdoff in analog oscilloscopes is a function of the time base setting, making it necessary to readjust the holdoff each time you change the time base setting.

With Agilent's MegaZoom technology, you can press **Stop**, then pan and zoom through the data to find where it repeats. Measure this time using the cursors, then set the holdoff.

The External Trigger input

The External Trigger input can be used as a source in several of the trigger types.

On 2-channel oscilloscopes, the external trigger BNC input is on the front panel and is labeled **Ext Trigger**.

On 4-channel oscilloscopes, the external trigger BNC input is on the rear panel and is labeled **Ext Trig**.

2-Channel oscilloscope External Trigger input

External Trigger Probe Settings

You can set external trigger probe parameters as described below.

- 1 Press the **Mode/Coupling** key in the Trigger section of the front panel.



- 2 Press the **External** softkey to display the external trigger probe menu.

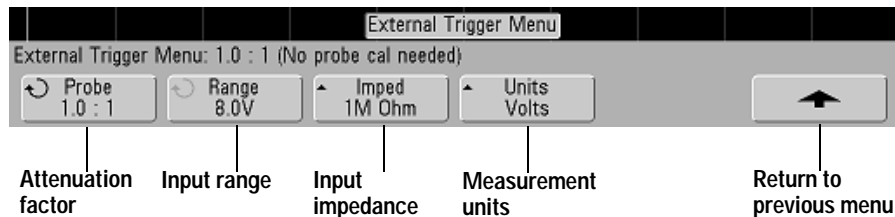

Probe Attenuation Turn the Entry knob to set the attenuation factor displayed in the **Probe** softkey for the connected probe. The attenuation factor can be set from 0.1:1 to 1000:1 in a 1-2-5 sequence.

When you connect an AutoProbe self-sensing probe, the oscilloscope will automatically configure your probe to the correct attenuation factor. Note that the AutoProbe feature is not available on 100 MHz bandwidth models.

The probe correction factor must be set properly for measurements to be made correctly.

Range The input voltage range can be set to 1.0 Volts or 8.0 Volts. When in current mode, the range is fixed at 1.0 Amps. Range is automatically scaled according to the probe's attenuation factor.

Maximum input voltage for the external trigger input of the 2-channel oscilloscope:

CAUTION



Maximum input voltage for external trigger (2-channel oscilloscopes)

CAT I 300 Vrms, 400 Vpk; transient overvoltage 1.6 kVpk

CAT II 100 Vrms, 400 Vpk

with 10073C or 10074C 10:1 probe: CAT I 500 Vpk, CAT II 400 Vpk

CAUTION



Do not exceed 5 Vrms in 50 Ω mode. Input protection is enabled in 50 Ω mode and the 50 Ω load will disconnect if greater than 5 Vrms is detected. However the input could still be damaged, depending on the time constant of the signal. The 50 Ω input protection mode only functions when the oscilloscope is powered on.

Input Impedance The 300 MHz, 500 MHz, and 1 GHz bandwidth 2-channel oscilloscopes have selectable external trigger input impedance. The impedance can be set to either **1M Ohm** or **50 Ohm** by pressing the **Imped** softkey. The input impedance of 100 MHz bandwidth models is fixed at 1M Ω .

- **50 Ohm** mode matches 50-ohm cables commonly used in making high frequency measurements. This impedance matching gives you the most accurate measurements since reflections are minimized along the signal path.

- **1M Ohm** mode is for use with many passive probes and for general-purpose measurements. The higher impedance minimizes the loading effect of the oscilloscope on the circuit under test.

Probe Units Press the **Units** softkey to select the proper measurement unit for the connected probe. Select **Volts** for a voltage probe and select **Amps** for a current probe. Measurement results, channel sensitivity, and trigger level will reflect the measurement units you have selected.

4-Channel oscilloscope External Trigger input

Input Impedance The external trigger input impedance for the 4-channel oscilloscope is approximately 2.14 k Ω (~1.015 k Ω on 100 MHz bandwidth models).

Input Voltage The input voltage sensitivity is 500 mV, from DC to 500 MHz (DC to 100 MHz on 100 MHz bandwidth models). The input voltage range is ± 15 V.

CAUTION



Maximum input voltage for external trigger (4-channel oscilloscopes)
Do not exceed 15 V_{rms} at rear panel External Trigger input or damage to the oscilloscope may occur.

There are no range or units settings for the External Trigger input of the 4-channel oscilloscope.

Trigger Types

The oscilloscope lets you synchronize the display to the actions of the circuit under test by defining a trigger condition. You can use any input channel or the Ext Trigger BNC as the source for most trigger types.

MegaZoom Technology Simplifies Triggering

With the built-in MegaZoom technology, you can simply AutoScale the waveforms, then stop the oscilloscope to capture a waveform. You can then pan and zoom through the data using the Horizontal and Vertical knobs to find a stable trigger point. AutoScale often produces a triggered display.

These trigger types are available and are presented in the following order in this chapter:

- Edge trigger
- Pulse Width (glitch) trigger
- Pattern trigger
- CAN (Controller Area Network) trigger
- Duration trigger
- FlexRay
- I²C (Inter-IC bus) trigger
- Nth Edge Burst trigger
- LIN (Local Interconnect Network)
- Sequence trigger
- SPI (Serial Peripheral Interface) trigger
- TV trigger
- USB (Universal Serial Bus) trigger

Changes to the trigger specification are applied when you make them. If the oscilloscope is stopped when you change a trigger specification, the oscilloscope will use the new specification when you press **Run/Stop** or **Single**. If the oscilloscope is running when you change a triggering specification, it uses the new trigger definition when it starts the next acquisition.

To use Edge triggering

The Edge trigger type identifies a trigger by looking for a specified edge (slope) and voltage level on a waveform. You can define the trigger source and slope in this menu. The slope can be set to rising edge or falling edge, and can be set to alternating edges or either edge on all sources except Line. The trigger type, source, and level are displayed in the upper-right corner of the display.

- 1 Press the **Edge** key in the Trigger section of the front panel to display the Edge trigger menu.

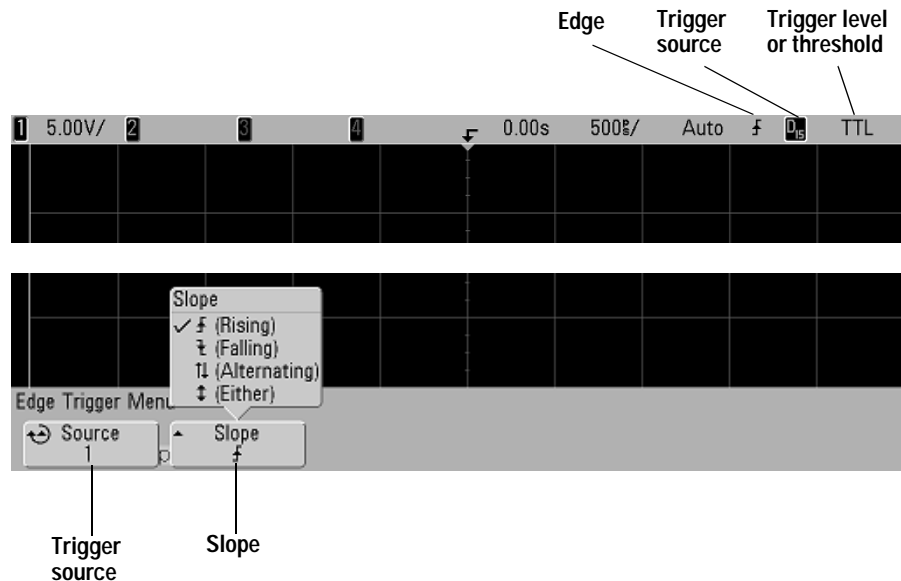

- 2 Press the **Slope** softkey and select rising edge, falling edge, alternating edges, or either edge. The selected slope is displayed in the upper-right corner of the display.

NOTE

Alternating edge mode is useful when you want to trigger on both edges of a clock (for example, DDR signals). Either edge mode is useful when you want to trigger on any activity of a selected source. All modes operate up to the bandwidth of the oscilloscope except Either edge mode, which has a limitation. Either edge mode will trigger on Constant Wave signals up to 100 MHz, but can trigger on isolated pulses down to $1/(2 \times \text{oscilloscope's bandwidth})$.

3 Select the trigger source.

You can select analog channel 1 or 2, Ext, or Line as the trigger source on any Agilent 6000 Series oscilloscope. The trigger source can also be set to channel 3 and 4 on the 4-channel oscilloscopes, or digital channels D15 through D0 on the mixed-signal oscilloscopes. You can choose a channel that is turned off (not displayed) as the source for the edge trigger.

The selected trigger source is indicated in the upper-right corner of the display next to the slope symbol:

1 through 4 = analog channels

D0 through D15 = digital channels

E = External trigger

L = Line trigger

Trigger level adjustment

You can adjust the trigger level for a selected analog channel by turning the Trigger Level knob. The position of the trigger level for the analog channel is indicated by the trigger level icon \triangleright (if the analog channel is on) at the far left side of the display when DC coupling is selected. The value of the analog channel trigger level is displayed in the upper-right corner of the display.

The trigger level for a selected digital channel is set using the threshold menu in the Digital Channel Menu. Press the **D15 Thru D0** key on the front panel, then press the **Thresholds** softkey to

set the threshold level (TTL, CMOS, ECL, or user defined) for the selected digital channel group. The threshold value is displayed in the upper-right corner of the display.

When **Ext** (External Trigger) is selected, its level can be adjusted using the **Level** knob in the Trigger section of the front panel. The trigger level is displayed in the upper right corner of the display.

The line trigger level is not adjustable. This trigger is synchronized with the power line supplied to the oscilloscope.

To use Pulse Width triggering

Pulse Width (glitch) triggering sets the oscilloscope to trigger on a positive or negative pulse of a specified width. If you want to trigger on a specific timeout value, use **Duration** trigger in the Trigger **More** menu.

- 1 Press the **Pulse Width** key in the Trigger section of the front panel to display the Pulse Width trigger menu.

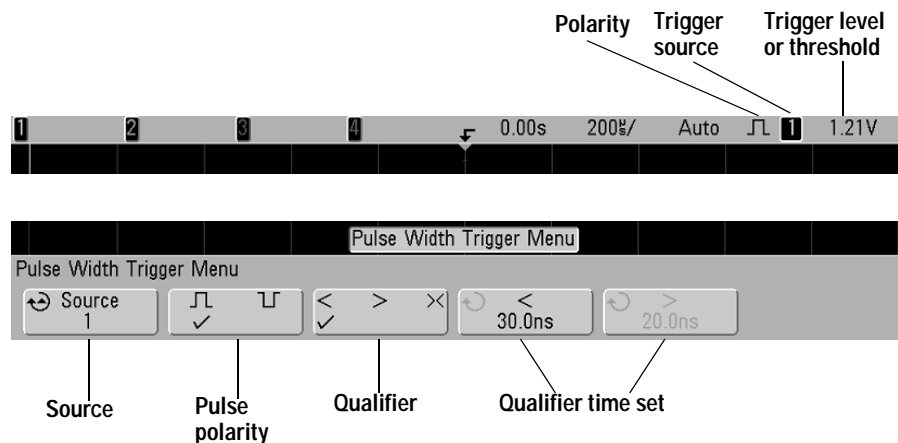

- 2 Press the **Source** softkey (or rotate the Entry knob on mixed-signal oscilloscopes) to select a channel source for the trigger.

The channel you select is shown in the upper-right corner of the display next to the polarity symbol.

The source can be any analog or digital channel available on your oscilloscope. External trigger may also be specified as a source when using a 2-channel oscilloscope.

Adjust the trigger level for the selected analog channel by turning the Trigger Level knob. Press the **D15 Thru D0** key and select **Thresholds** to set the threshold level for digital channels. The value of the trigger level or digital threshold is displayed in the upper-right corner of the display.

- 3 Press the pulse polarity softkey to select positive (\uparrow) or negative (\downarrow) polarity for the pulse width you want to capture.

The selected pulse polarity is displayed in the upper-right corner of the display. A positive pulse is higher than the current trigger level or threshold and a negative pulse is lower than the current trigger level or threshold.

When triggering on a positive pulse, the trigger will occur on the high to low transition of the pulse if the qualifying condition is true. When triggering on a negative pulse, the trigger will occur on the low to high transition of the pulse if the qualifying condition is true.

- 4 Press the qualifier softkey (< > ><) to select the time qualifier.

The Qualifier softkey can set the oscilloscope to trigger on a pulse width that is:

- less than a time value (<).

For example, for a positive pulse, if you set $t < 10$ ns:

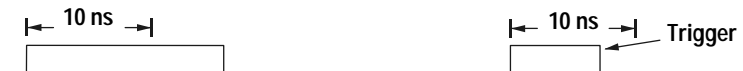

- greater than a time value (>).

For example, for a positive pulse, if you set $t > 10$ ns:



- within a range of time values ($><$).

For example, for a positive pulse, if you set $t > 10$ ns and $t < 15$ ns:

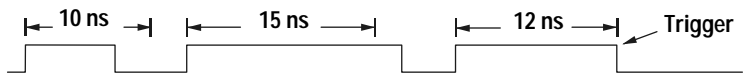

- 5 Select the qualifier time set softkey ($<$ or $>$), then rotate the Entry knob to set the pulse width qualifier time.

The qualifiers can be set as follows:

- 2 ns to 10 s for $>$ or $<$ qualifier (5 ns to 10 s for 100 MHz and 300 MHz bandwidth models)
- 10 ns to 10 s for $><$ qualifier, with minimum difference of 5 ns between upper and lower settings

$<$ qualifier time set softkey

- When the less than ($<$) qualifier is selected, the Entry knob sets the oscilloscope to trigger on a pulse width less than the time value displayed on the softkey.
- When the time range ($><$) qualifier is selected, the Entry knob sets the upper time range value.

$>$ qualifier time set softkey

- When the greater than ($>$) qualifier is selected, the Entry knob sets the oscilloscope to trigger on a pulse width greater than the time value displayed on the softkey.
- When the time range ($><$) qualifier is selected, the Entry knob sets the lower time range value.

To use Pattern triggering

The Pattern trigger identifies a trigger condition by looking for a specified pattern. This pattern is a logical AND combination of the channels. Each channel can have a value of high (H), low (L), don't care (X). A rising or falling edge can be specified for one channel included in the pattern. You can also trigger on a hex bus value as described on page 155.

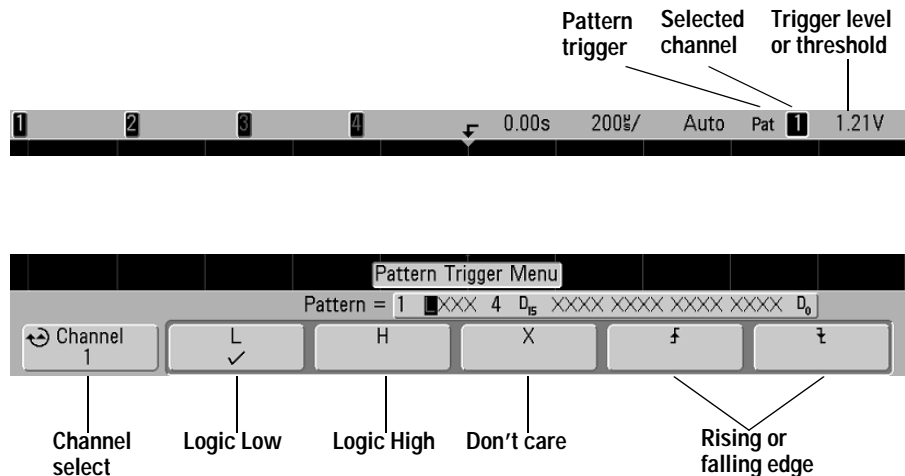

- 1 Press the **Pattern** key in the Trigger section of the front panel to display the Pattern trigger menu.



- 2 For each analog or digital channel you want to include in the desired pattern, press the **Channel** softkey to select the channel.

This is the channel source for the H, L, X, or edge condition. As you press the **Channel** softkey (or rotate the Entry knob on mixed-signal oscilloscopes), the channel you select is highlighted in the **Pattern =** line directly above the softkeys and in the upper-right corner of the display next to “**Pat**”. External trigger may also be specified as a channel in the pattern when using the 2-channel and 4-channel oscilloscopes.

Adjust the trigger level for the selected analog channel by turning the Trigger Level knob. Press the **D15 Thru D0** key and select **Thresholds** to set the threshold level for digital channels. The value of the trigger level or digital threshold is displayed in the upper-right corner of the display.

- 3 For each channel you select, press one of the condition softkeys to set the condition for that channel in the pattern.
- **H** sets the pattern to high on the selected channel. A high is a voltage level that is greater than the channel's trigger level or threshold level.
 - **L** sets the pattern to low on the selected channel. A low is a voltage level that is less than the channel's trigger level or threshold level.
 - **X** sets the pattern to don't care on the selected channel. Any channel set to don't care is ignored and is not used as part of the pattern. However, if all channels in the pattern are set to don't care, the oscilloscope will not trigger.
 - The rising edge () or falling edge () softkey sets the pattern to an edge on the selected channel. Only one rising or falling edge can be specified in the pattern. When an edge is specified, the oscilloscope will trigger at the edge specified if the pattern set for the other channels is true.

If no edge is specified, the oscilloscope will trigger on the last edge that makes the pattern true.

Specifying an Edge in a Pattern

You are allowed to specify only one rising or falling edge term in the pattern. If you define an edge term, then select a different channel in the pattern and define another edge term, the previous edge definition is changed to a don't care.

For information regarding digital bus display when Pattern triggering see page 133.

Hex Bus Pattern Triggering

You can specify a bus value on which to trigger. To do this, first define the bus. See “To display digital channels as a bus” on page 130 for details. You can trigger on a bus value whether you are displaying the bus or not.

To trigger on a bus value:

- 1 Press the **Pattern** key on the front panel.
- 2 Press the **Channel** softkey and rotate the Entry knob to select **Bus1** or **Bus2**.
- 3 Press the **Digit** softkey and rotate the Entry knob to select a digit of the selected bus.
- 4 Press the **Hex** softkey and rotate the Entry knob to select a value for the digit.

NOTE

If a digit is made up of less than four bits, then the value of the digit will be limited to the value that can be created by the selected bits.

- 5 You can use the **Set all Digits** softkey to set all digits to a particular value.

When a hex bus digit contains one or more don't care (X) bits and one or more bit with a value of 0 or 1, the “\$” sign will be displayed for the digit.

For information regarding digital bus display when Pattern triggering see “Bus values are displayed when using Pattern trigger” on page 133.

To use CAN triggering

NOTE

For CAN decode setup see page 311.

Controller Area Network (CAN) trigger will trigger on CAN version 2.0A and 2.0B signals. Setup consists of connecting the oscilloscope to a CAN signal, using the **Settings** menu to specify the event to trigger on, and using the **Signals** menu to specify the signal source, baud rate, and sample point.

The CAN trigger will trigger on the Start of Frame (SOF) bit of a data frame. If the N5424A CAN/LIN Automotive Triggering and Decode option is installed on your oscilloscope, the following additional CAN trigger types will also be available: Remote Frame ID (RTR), Data Frame ID (~RTR), Remote or Data Frame ID, Data Frame ID and Data, Error Frame, All Errors, Acknowledge Error, and Overload Frame.

A CAN message frame in CAN_L signal type is shown below:

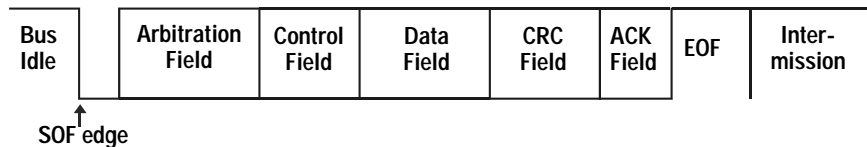

- 1 Press the **Label** key on the front panel to switch labels on.
- 2 Press the **More** key in the Trigger section of the front panel, rotate the Entry knob until **CAN** is displayed in the **Trigger** softkey.

3 Press the **Settings** softkey to display CAN trigger menu.

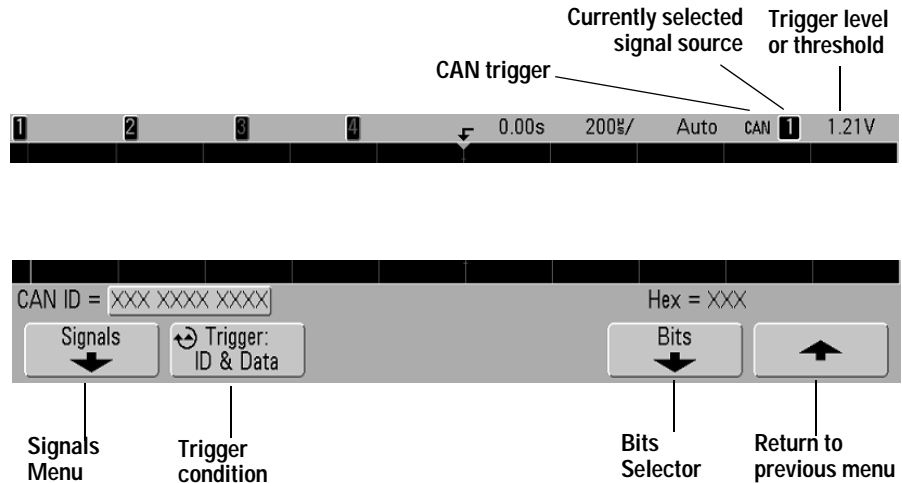

4 Repeatedly press and release the **Trigger:** softkey or rotate the Entry knob to select the trigger condition.

- **SOF - Start of Frame** – The oscilloscope triggers at the start of a frame.
- **Remote Frame ID (RTR)** – The oscilloscope triggers on remote frames with the specified ID. Press the **Bits** softkey to select the ID.

NOTE

For details about using the Bits softkeys, press and hold the softkey in question to display the built-in help for this subject.

- **Data Frame ID (~RTR)** - The oscilloscope will trigger on data frames matching the specified ID. Press the **Bits** softkey to select the ID.
- **Remote or Data Frame ID** - The oscilloscope will trigger on remote or data frames matching the specified ID. Press the **Bits** softkey to select the ID.
- **Data Frame ID and Data** - The oscilloscope will trigger on data frames matching the specified ID and data. Press the **Bits** softkey to select the ID and set up the number of data bytes and values.
- **Error Frame** - The oscilloscope will trigger on CAN active error frames.

4 Triggering the Oscilloscope

- **All Errors** - The oscilloscope will trigger when any form error or active error is encountered.
- **Acknowledge Error** - The oscilloscope will trigger when the acknowledge bit is recessive (high).
- **Overload Frame** - The oscilloscope will trigger on CAN overload frames.

5 Press the **Signals** softkey to enter the CAN Signals menu.

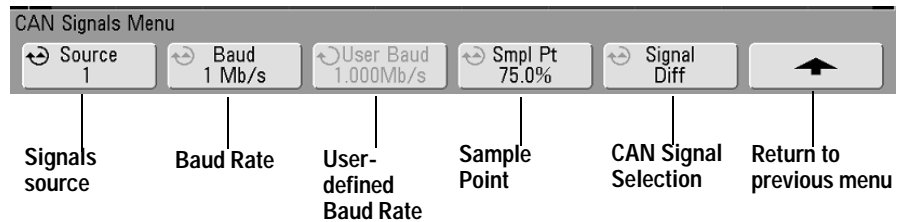
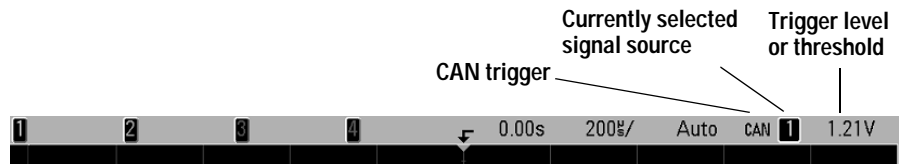

6 Press the **Source** softkey to select the channel connected to the CAN signal line.

As you repeatedly press the **Source** softkey (or rotate the Entry knob), the **CAN** label for the source channel is automatically set and the channel you select is shown in the upper-right corner of the display next to “CAN”.

Adjust the trigger level for the selected analog channel by turning the Trigger Level knob. Press the **D15 Thru D0** key and select **Thresholds** to set the threshold level for digital channels. The value of the trigger level or digital threshold is displayed in the upper-right corner of the display.

7 Press the **Signal** softkey and select the type and polarity of the CAN signal. This also automatically sets the channel label for the source channel.

- **CAN_H** - The actual CAN_H differential bus

Dominant low signals:

- **CAN_L** - The actual CAN_L differential bus signal
- **Rx** - The Receive signal from the CAN bus transceiver
- **Tx** - The Transmit signal from the CAN bus transceiver
- **Differential** - The CAN differential bus signals connected to an analog source channel using a differential probe. Connect the probe's positive lead to the dominant-low CAN signal (CAN_L) and connect the negative lead to the dominant-high CAN signal (CAN_H).

- 8 Repeatedly press and release the **Baud** softkey to set the CAN signal baud rate to match your CAN bus signal.

The CAN baud rate presets are:

10 kb/s	50 kb/s	100 kb/s	500 kb/s
20 kb/s	62.5 kb/s	125 kb/s	800 kb/s
33.3 kb/s	83.3 kb/s	250 kb/s	1 Mb/s
User Defined			

The default baud rate is 1 Mb/s

If the desired baud rate is not shown in the table, select User Defined. You can set the CAN baud rate from 10.0 kb/s to 1.000 Mb/s in increments of 100 b/s. Press the **User Baud** softkey and rotate the Entry knob to make your selection.

- 9 Repeatedly press and release the **Smpl Pt** softkey to select the point between phase segments 1 and 2 where the state of the bus is measured. This controls the point within the bit's time where the bit value is captured.

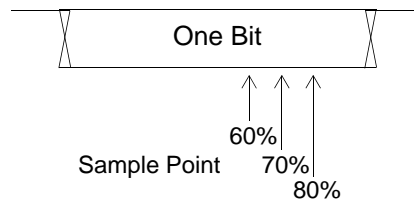

You can use the **Zoom** mode for easier navigation of the decoded data.

NOTE

If the setup does not produce a stable trigger, the CAN signal may be slow enough that the oscilloscope is AutoTriggering. Press the **Mode/Coupling** key, then press the **Mode** softkey to set the trigger mode from **Auto** to **Normal**.

To use Duration triggering

Duration trigger lets you define a pattern, then trigger on a specified time duration of this logical AND combination of the channels.

- 1 Press the **More** key in the Trigger section of the front panel, rotate the Entry knob until **Duration** is displayed in the **Trigger** softkey, then press the **Settings** softkey to display the Duration trigger menu.

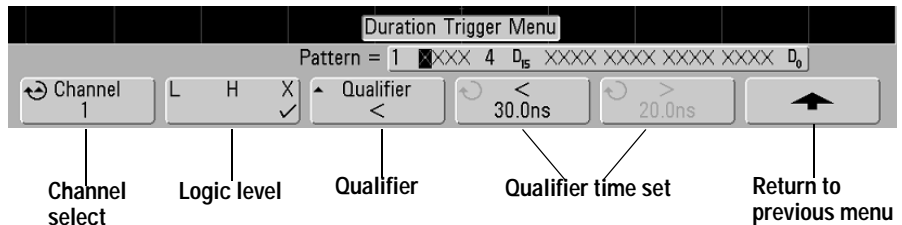

- 2 For each analog or digital channel you want to include in the desired pattern, press the **Channel** softkey to select the channel.

This is the channel source for the H, L, or X condition. As you press the **Channel** softkey (or rotate the Entry knob on mixed-signal oscilloscopes), the channel you select is highlighted in the **Pattern =** line directly above the softkeys and in the upper-right corner of the display next to “**Dur**”. External trigger may also be specified as a channel in the pattern when using the 2-channel and 4-channel oscilloscopes.

Adjust the trigger level for the selected analog channel by turning the Trigger Level knob. Press the **D15 Thru D0** key and select **Thresholds** to set the threshold level for digital channels. The value of the trigger level or digital threshold is displayed in the upper-right corner of the display.

- 3 For each channel you select, press the logic level softkey to set the condition for that channel in the pattern.
 - **H** sets the pattern to high on the selected channel. A high is a voltage level that is greater than the channel's trigger level or threshold level.
 - **L** sets the pattern to low on the selected channel. A low is a voltage level that is less than the channel's trigger level or threshold level.
 - **X** sets the pattern to don't care on the selected channel. Any channel set to don't care is ignored and is not used as part of the pattern. If all channels in the pattern are set to don't care, the oscilloscope will not trigger.
- 4 Press the **Qualifier** softkey to set the time duration qualifier for the pattern.

The time qualifier can set the oscilloscope to trigger on a channel pattern whose time duration is:

- less than a time value (<)
- greater than a time value (>)
- greater than a time value, but with timeout (**Timeout**). A trigger will be forced at the timeout value, rather than occurring when the pattern is exited.
- within a range of time values (><)
- outside a range of time values (<>)

The time values for the selected qualifier are set using the qualifier time set softkeys (< and >) and the Entry knob.

- 5 Select a qualifier time set softkey (< or >), then rotate the Entry knob to set the duration qualifier time.

< qualifier time set softkey

- When the less than (<) qualifier is selected, the Entry knob sets the oscilloscope to trigger on a pattern duration less than the time value displayed on the softkey.
- When the within time range (><) qualifier is selected, the Entry knob sets the upper time range value.
- When the out of time range (<>) qualifier is selected, the Entry knob sets the lower time range value.

> qualifier time set softkey

- When the greater than (>) qualifier is selected, the Entry knob sets the oscilloscope to trigger on a pattern duration greater than the time value displayed on the softkey.
- When the within time range (><) qualifier is selected, the Entry knob sets the lower time range value.
- When the out of time range (<>) qualifier is selected, the Entry knob sets the upper time range value.
- When **Timeout** qualifier is selected, the Entry knob sets the timeout value.

When the duration trigger occurs

The timer starts on the last edge that makes the pattern (logical AND) true. The trigger will occur on the first edge that makes the pattern false if the time qualifier criteria of the pattern has been met, except in Timeout mode. In Timeout, the trigger occurs when the timeout value is reached while the pattern is true.

To use FlexRay triggering

To trigger on FlexRay data, you need a four-channel 7000 Series mixed signal oscilloscope, the Option FRS (N5432B) FlexRay triggering and decode option, which includes the Agilent VPT1000 protocol analyzer module, and its MSO communications cable. The Option FRS allows you to:

- Control the VPT1000 (without a PC).
- Trigger on FlexRay bus frames, synchronous timing slots/segments, or error conditions.
- Display decoded FlexRay bus data and synchronous timing.

Triggering on FlexRay Frames, Times, or Errors

- 1 To trigger on FlexRay data, you must first set up communication between the oscilloscope and the VPT1000. See “Setting Up the Oscilloscope and the VPT1000” on page 326.
- 2 In the Trigger section on the front panel, press the **More** key.
- 3 Press the **Trigger** softkey, and use the Entry knob to select **FlexRay**.
- 4 Press the **Settings** softkey to access the FlexRay Trigger Menu.

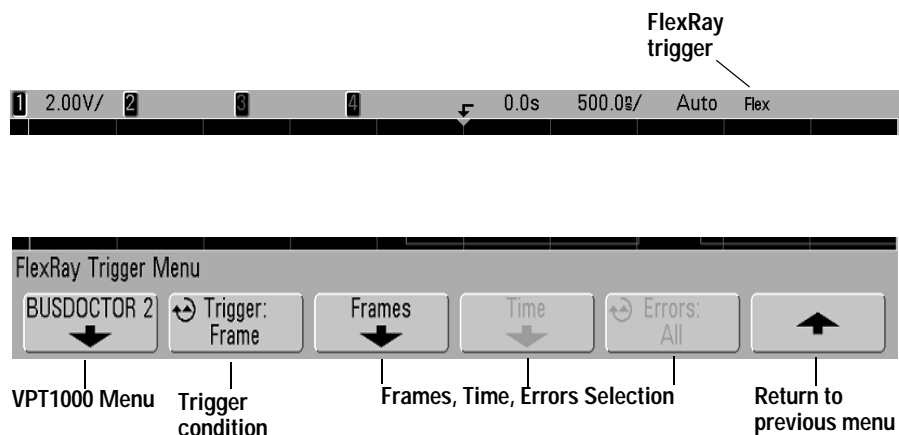

Triggering on FlexRay Frames

- 5 In the FlexRay Trigger Menu press the **Trigger** softkey, and use the Entry knob to select **Frame**.
- 6 Press the **Frames** softkey to access the FlexRay Frame Trigger Menu.
- 7 Press the **Frame ID** softkey, and use the Entry knob to select the frame ID value from **All** or **1** to **2047**.
- 8 Press the **Frame Type** softkey to select the frame type:
 - **All Frames**
 - **Startup Frames**
 - **NULL Frames**
 - **Sync Frames**
 - **Normal Frames**
 - **NOT Startup Frames**
 - **NOT NULL Frames**
 - **NOT Sync Frames**
- 9 Press the **Cyc Ct Rep** softkey, and use the Entry knob to select the cycle count repetition factor (**2**, **4**, **8**, **16**, **32**, or **64**, or **All**).
- 10 Press the **Cyc Ct Bas** softkey, and use the Entry knob to select the cycle count base factor from **0** through the **Cyc Ct Rep** factor minus 1.

For example, with a base factor of 1 and a repetition factor of 16, the oscilloscope triggers on cycles 1, 17, 33, 49, and 65.

To trigger on a particular cycle, set the Cycle Repetition factor to 64 and use the cycle base factor to choose a cycle.

To trigger all (any) cycles, set the Cycle Repetition factor to **All**. The scope will trigger on any and all cycles.

NOTE

Since specific FlexRay frames may occur infrequently it may be helpful to set the oscilloscope to Normal trigger mode instead of Auto trigger mode. This prevents the oscilloscope from Auto triggering while waiting for a particular frame and cycle combination.

Triggering on the FlexRay Time Schedule

In the **Time** trigger mode, the oscilloscope triggers on scheduled slot numbers and segments, not actual frame contents.

NOTE

To establish time triggering, the oscilloscope and VPT1000 must be set to the synchronous mode of operation. (Press the VPT1000 softkey in the FlexRay trigger or FlexRay decode menu, then press the Mode softkey. A FIBEX file that defines the schedule must be loaded.)

- 1 In the FlexRay Trigger Menu press the **Trigger** softkey, and use the Entry knob to select **Time**.
- 2 Press the **Time** softkey to access the FlexRay Time Trigger Menu.
- 3 Press the **Segment** softkey to select the segment type:
 - **Static Segments**
 - **Dynamic Segments**
 - **Symbol Segments**
 - **Idle Segments**
- 4 When **Static** or **Dynamic Segments** are selected:
 - a Press the **Slot #** softkey, and use the Entry knob to select the slot number to trigger on. The maximum static slot value and the minimum dynamic slot value are limited by the downloaded FIBEX file schedule.
 - b Press the **Slot Type** softkey to select the slot type:
 - **All Slots** – the oscilloscope triggers on slots regardless of whether they contain a frame.
 - **Empty Slots** – the oscilloscope triggers when a slot does not contain a frame. Usually used to determine if an assigned slot is empty when it should have contained a frame.
- 5 Press the **Cyc Ct Rep** softkey, and use the Entry knob to select the cycle repetition factor from **2, 4, 8, 16, 32, 64, or All**.
- 6 Press the **Cyc Ct Bas** softkey, and use the Entry knob to select the cycle base factor from **0** through the **Cyc Ct Rep** value minus 1.

NOTE

Since up to 64 cycles can be defined for FlexRay it may be helpful to set the oscilloscope to Normal trigger mode instead of Auto trigger mode. This prevents the oscilloscope from Auto triggering while waiting for a particular slot in a particular cycle.

Triggering on FlexRay Errors

- 1 In the Trigger section on the front panel, press the **More** key.
- 2 Press the **Trigger** softkey, and use the Entry knob to select **FlexRay**.
- 3 Press the **Settings** softkey to access the FlexRay Trigger Menu.
- 4 In the FlexRay Trigger Menu, press the **Trigger** softkey, and use the Entry knob to select **Error**.
- 5 Press the **Errors** softkey, and use the Entry knob to select the error type:
 - **All Errors**
 - **Code Error (NRZ)** – NRZ decoding errors only.
 - **TSS Violation** – transmission start sequence violation.
 - **Header CRC Error** – cyclic redundancy check error in the header.
 - **Frame CRC Error** – cyclic redundancy check error in the frame.
 - **Frame End Sequence Error** – indicates that the FES has been violated.
 - **Boundary Violation** – frame received overlaps slot boundaries (synchronous monitoring mode only).
 - **Network Idle Time Violation** – frame received with NIT (synchronous monitoring mode only).
 - **Symbol Window Violation** – frame received within symbol window, or symbol received outside of symbol window (synchronous monitoring mode only).
 - **Slot Overbooked Error** – two or more communication elements have been received within one slot.
 - **Null Frame Error** – null frame received within dynamic segment (synchronous monitoring mode only).

- **Sync or Startup Error** – sync bit or startup bit set within dynamic segment (synchronous monitoring mode only).
- **Frame ID Error** – mismatch between internal and received slot ID (synchronous monitoring mode only).
- **Cycle Count Error** – mismatch between internal and received cycle counter (synchronous monitoring mode only).
- **Static Payload Length Error** – unexpected payload length within static segment (synchronous monitoring mode only).

NOTE

Since FlexRay errors occur infrequently it may be helpful to set the oscilloscope to Normal trigger mode instead of Auto trigger mode. This prevents the oscilloscope from Auto triggering while waiting for an error to occur. You may need to adjust trigger holdoff to see a particular error when multiple errors exist.

To use I²C triggering

NOTE

For I²C decode setup see page 302.

An I²C (Inter-IC bus) trigger setup consists of connecting the oscilloscope to the serial data (SDA) line and the serial clock (SCL) line, then triggering on a stop/start condition, a restart, a missing acknowledge, an EEPROM data read, or on a read/write frame with a specific device address and data value.

- 1 Press the **More** key in the Trigger section of the front panel, rotate the Entry knob until **I²C** is displayed in the **Trigger** softkey, then press the **Settings** softkey to display the I²C trigger menu.

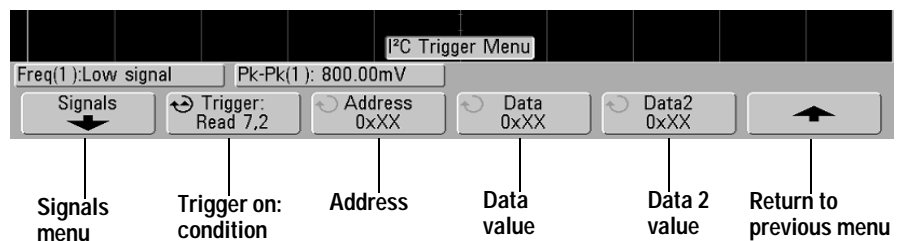
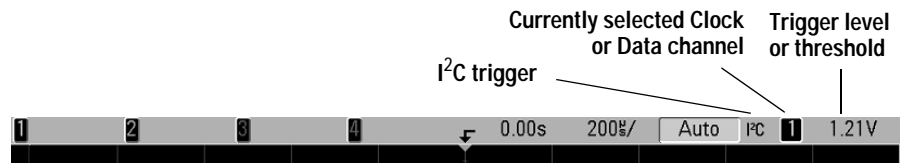

- 2 Press the **Label** key on the front panel to switch labels on.

- 3 Press the **Signals** softkey to display the I²C signals menu.

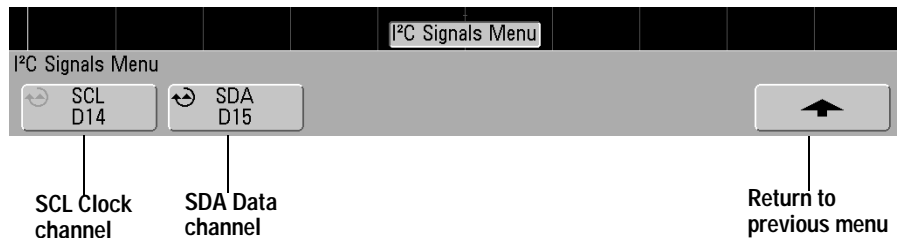

- 4 Connect an oscilloscope channel to the SCL (serial clock) line in the circuit under test, then set the **SCL** clock channel softkey to that channel.

As you press the **SCL** softkey (or rotate the Entry knob on mixed-signal oscilloscopes), the **SCL** label for the source channel is automatically set and the channel you select is shown in the upper-right corner of the display next to “I²C”.

Adjust the trigger level for the selected analog channel by turning the Trigger Level knob. Press the **D15 Thru D0** key and select **Thresholds** to set the threshold level for digital channels. The value of the trigger level or digital threshold is displayed in the upper-right corner of the display.

- 5 Choose 7-bit or 8-bit address size. Use 8-bit address size to include the R/W bit as part of the address value, or choose 7-bit address size to exclude the R/W bit from the address value.
- 6 Connect an oscilloscope channel to the SDA (serial data) line in the circuit under test, then set the **SDA** data channel softkey to that channel.

As you press the **SDA** softkey (or rotate the Entry knob on mixed-signal oscilloscopes), the **SDA** label for the source channel is automatically set and the channel you select is shown in the upper-right corner of the display next to “I²C”.

Adjust the trigger level for the selected analog channel by turning the Trigger Level knob. Press the **D15 Thru D0** key and select **Thresholds** to set the threshold level for digital channels. The value of the trigger level or digital threshold is displayed in the upper-right corner of the display.

Data needs to be stable during the whole high clock cycle or it will be interpreted as a start or stop condition (data transitioning while the clock is high).

7 Return to the previous menu; then, press the **Trigger**: softkey to select one of the following I²C trigger conditions:

- **Start Condition** – The oscilloscope triggers when SDA data transitions from high to low while the SCL clock is high. For triggering purposes (including frame triggers), a restart is treated as a start condition.
- **Stop Condition** – The oscilloscope triggers when data (SDA) transitions from low to high while the clock (SCL) is high.

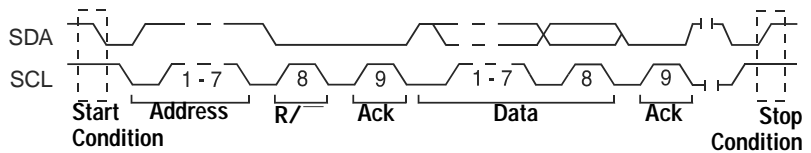

- **Missing Acknowledge** – The oscilloscope triggers when SDA data is high during any Ack SCL clock bit.
- **Address with no Ack** – The oscilloscope triggers when the acknowledge of the selected address field is false. The R/W bit is ignored.
- **Restart** – The oscilloscope triggers when another start condition occurs before a stop condition.

- **EEPROM Data Read** – The trigger looks for EEPROM control byte value 1010xxx on the SDA line, followed by a Read bit and an Ack bit. It then looks for the data value and qualifier set by the **Data** softkey and the **Data is** softkey. When this event occurs, the oscilloscope will trigger on the clock edge for the Ack bit after the data byte. This data byte does not need to occur directly after the control byte.

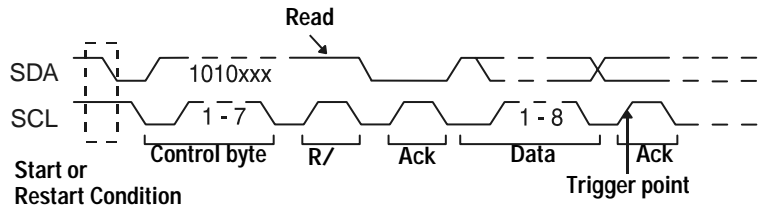

- **Frame (Start: Addr7: Read: Ack: Data) or Frame (Start: Addr7: Write: Ack: Data)** – The oscilloscope triggers on a read or write frame in 7-bit addressing mode on the 17th clock edge if all bits in the pattern match. For triggering purposes, a restart is treated as a start condition.

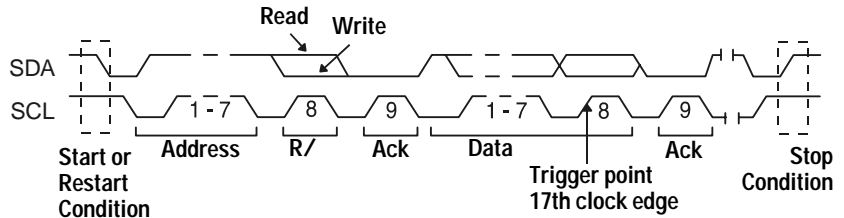

- **Frame (Start: Addr7: Read: Ack: Data: Ack: Data2) or Frame (Start: Addr7: Write: Ack: Data: Ack: Data2)** – The oscilloscope triggers on a read or write frame in 7-bit addressing mode on the 26th clock edge if all bits in the pattern match. For triggering purposes, a restart is treated as a start condition.

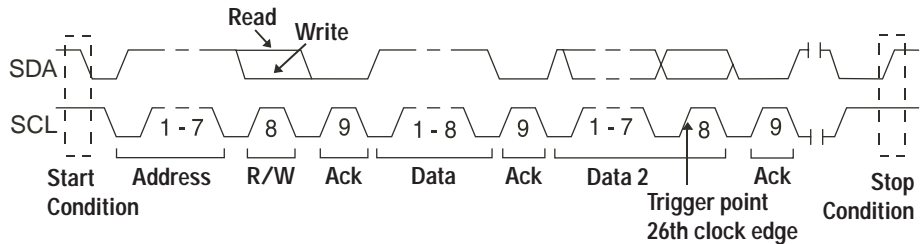

- **10-bit Write** – The oscilloscope triggers on a 10-bit write frame on the 26th clock edge if all bits in the pattern match. The frame is in the format:

Frame (Start: Address byte 1: Write: Address byte 2: Ack: Data)

For triggering purposes, a restart is treated as a start condition.

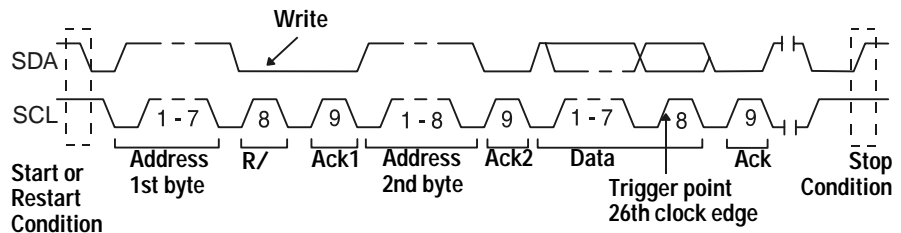

8 If you have set the oscilloscope to trigger on an EEPROM Data Read condition:

Press the **Data is** softkey to set the oscilloscope to trigger when data is = (equal to), \neq (not equal to), < (less than), or > (greater than) the data value set in the **Data** softkey.

The oscilloscope will trigger on the clock edge for the Ack bit after the trigger event is found. This data byte does not need to occur directly after the control byte. The oscilloscope will trigger on any data byte that meets the criteria defined by the **Data is** and **Data** softkeys during a current address read or a random read or a sequential read cycle.

- 9 If you have set the oscilloscope to trigger on a 7-bit address read or write frame condition or a 10-bit write frame condition:
 - a Press the **Address** softkey and turn the Entry knob to select the 7-bit or 10-bit device address.

You can select from an address range of 0x00 to 0x7F (7-bit) or 0x3FF (10-bit) hexadecimal. When triggering on a read/write frame, the oscilloscope will trigger after the start, address, read/write, acknowledge, and data events occur.

If don't care is selected (0xXX or 0xXXX) for the address, the address will be ignored. The trigger will always occur on the 17th clock for 7-bit addressing or 26th clock for 10-bit addressing.

- b Press the **Data** value softkey and turn the Entry knob to select the 8-bit data pattern on which to trigger.

You can select a data value in the range of 0x00 to 0xFF (hexadecimal). The oscilloscope will trigger after the start, address, read/write, acknowledge, and data events occur.

If don't care (0xXX) is selected for data, the data will be ignored. The trigger will always occur on the 17th clock for 7-bit addressing or 26th clock for 10-bit addressing.

- c If you have selected a three-byte trigger, press the **Data2** value softkey and turn the Entry knob to select the 8-bit data pattern on which to trigger.

To use Nth Edge Burst triggering

The Nth Edge Burst trigger lets you trigger on the Nth edge of a burst that occurs after an idle time.



Nth Edge Burst trigger set up consists of selecting the source, the slope of the edge, the idle time, and the number of the edge:

- 1 Press the **More** key in the Trigger section of the front panel, rotate the Entry knob until **Nth Edge Burst** is displayed in the **Trigger** softkey.
- 2 Press the **Settings** softkey to display the Nth Edge Burst trigger menu.

4 Triggering the Oscilloscope

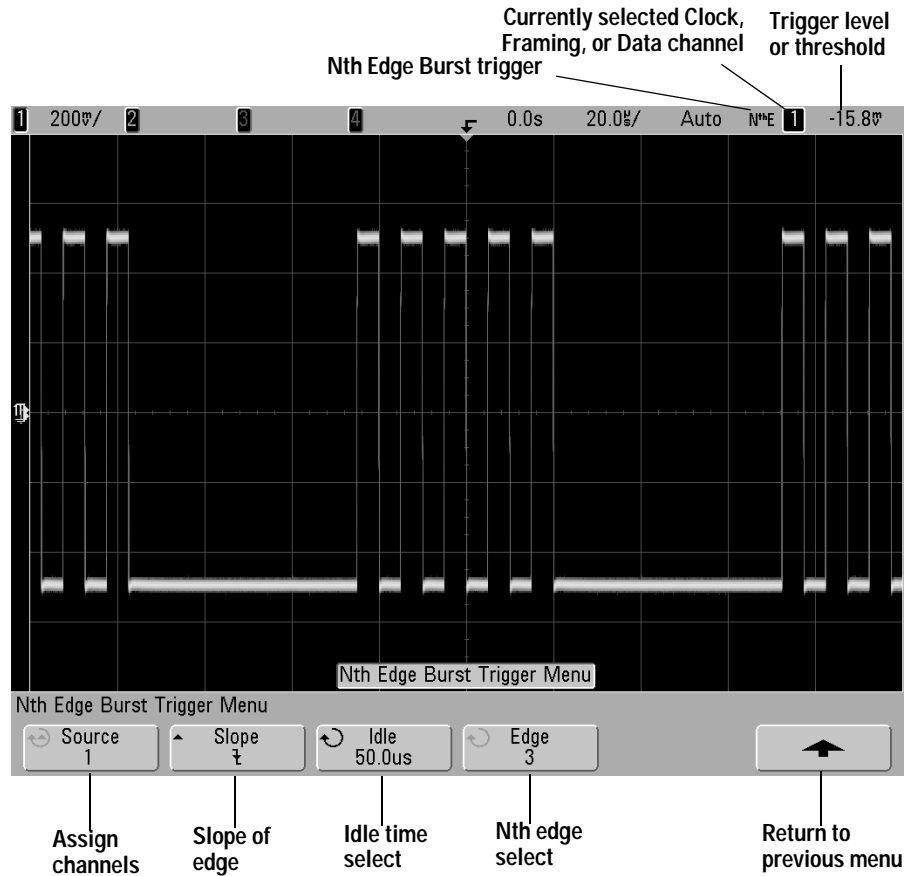

- 3 Press the **Slope** softkey to specify the slope of the edge.
- 4 Press the **Idle** softkey; then, turn the Entry knob to specify the idle time.
- 5 Press the **Edge** softkey; then, turn the Entry knob to which edge to trigger on.

To use LIN triggering

NOTE

For LIN decode information see page 319.

LIN (Local Interconnect Network) trigger setup consists of connecting the oscilloscope to a serial LIN signal.

LIN triggering will trigger on the rising edge at the Sync Break exit of the LIN single-wire bus signal that marks the beginning of the message frame. If the N5424A CAN/LIN Automotive Triggering and Decode option is installed on your oscilloscope, the Frame ID trigger type will also be available.

A LIN signal message frame is shown below:

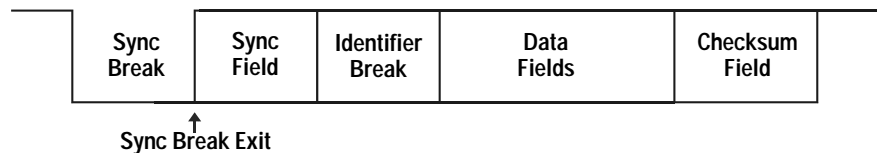

4 Triggering the Oscilloscope

- 1 Press the **More** key in the Trigger section of the front panel, rotate the Entry knob until **LIN** is displayed in the **Trigger** softkey.
- 2 Press the **Settings** softkey to display LIN trigger menu.

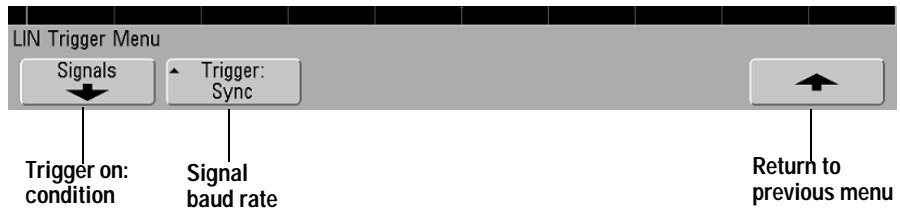
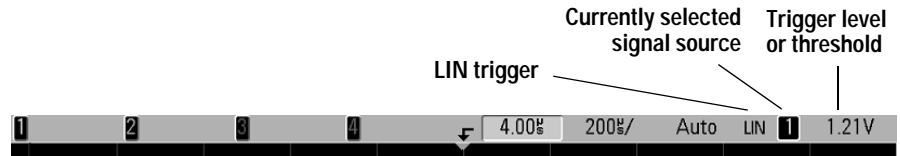

- 3 Press the **Trigger:** softkey and choose to trigger on Sync Break or Frame ID.

Sync (Sync Break) The oscilloscope will trigger on the rising edge at the Sync Break exit of the LIN single-wire bus signal that marks the beginning the message frame.

ID (Frame ID) The oscilloscope will trigger when a frame with an ID equal to the selected value is detected. Use the **Entry** knob to select the value for the Frame ID.

- 4 Press the **Signals** softkey. The LIN Signals Menu will be displayed.

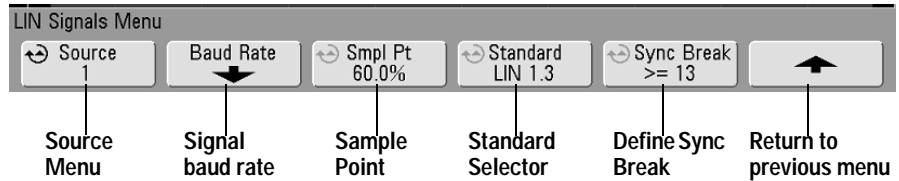

- 5 Press the **Source** softkey to select the channel connected to the LIN signal line.

Adjust the trigger level for the selected analog channel by turning the Trigger Level knob. Press the **D15 Thru D0** key and select **Thresholds** to set the threshold level for digital channels. The value of the trigger level or digital threshold is displayed in the upper-right corner of the display.

- 6 Press the **Baud** softkey to set the LIN signal baud rate to match your LIN bus signal.

The LIN baud rate can be set to 2400 b/s, 9600 b/s, 10.4 kb/s, 19.2 kb/s, 115.2 kb/s, 625 kb/s, or User Defined. The default baud rate is 2400 b/s.

If the desired baud rate is not shown in the list, select User Defined. You can set the LIN baud rate from 2.4 kb/s to 625 kb/s in increments of 100 b/s. Press the User Baud softkey and rotate the Entry knob to make your selection.

- 7 Press the **Smpl Pt** softkey to select the sample point at which the oscilloscope will sample the bit value.

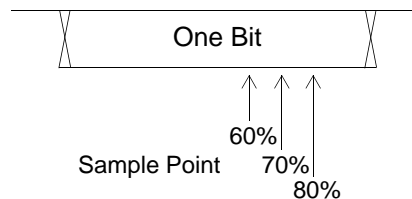

- 8 Press the **Standard** softkey to select the LIN standard you are measuring (LIN 1.3 or LIN 2.0).

4 Triggering the Oscilloscope

- 9 Press the **Sync Break** softkey and select the minimum number of clocks that define a sync break in your LIN signal.

To use Sequence triggering

Sequence trigger lets you trigger the oscilloscope after finding a sequence of events. Defining a sequence trigger requires three steps:

- 1 Define an event to find before you search for the trigger.

The “find” event can be a pattern, an edge from a single channel, or the combination of a pattern and a channel edge.

- 2 Define the trigger event.

The “trigger on” event can be a pattern, an edge from a single channel, the combination of a pattern and a channel edge, or the nth occurrence of an edge from a single channel.

- 3 Set an optional reset event.

If you choose to define a “reset” event, the event can be a pattern, an edge from a single channel, the combination of a pattern and a channel edge, or a timeout value.

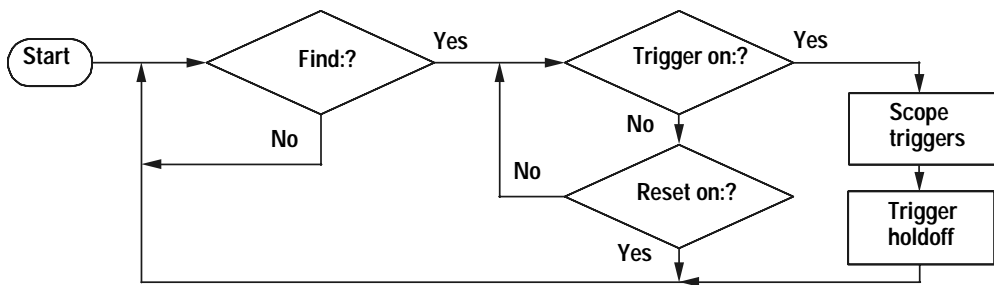

Figure 17 Sequence Trigger Flowchart

To access the sequence trigger settings, press the **More** key in the Trigger section of the front panel, rotate the Entry knob until **Sequence** is displayed in the **Trigger** softkey, then press the **Settings** softkey to display Sequence trigger menu.

4 Triggering the Oscilloscope

The image shows the oscilloscope's sequence trigger menu. At the top, there are labels: "Sequence trigger" pointing to the "Seq" button, "Selected channel" pointing to the "1" button, and "Trigger level or threshold" pointing to the "103" button. The main display area shows a grid with two waveforms, labeled "1" and "2". A "Sequence Stages" dialog box is open, showing "First, find: Pattern 1 Entered", "Then, trigger on: Pattern 2 Entered", and "Reset on: No Reset". Below this, a table lists stage definitions:

P1: 1	<input checked="" type="checkbox"/>	2	D ₁₅	XXXX	XXXX	XXXX	XXXX	D ₀
P2: 1	<input type="checkbox"/>	2	D ₁₅	XXXX	XXXX	XXXX	XXXX	D ₀
E1: 1	<input type="checkbox"/>	2	D ₁₅	XXXX	XXXX	XXXX	XXXX	D ₀
E2: 1	<input type="checkbox"/>	2	D ₁₅	XXXX	XXXX	XXXX	XXXX	D ₀

Below the table, it shows "N = 1" and "Timeout = 100ns". At the bottom, the "Sequence Trigger Menu" has several buttons: "Channel 1", "Stage Find", "Find: P1 Enter", "Term Pattern 1", "L H X", and an arrow button. Labels below these buttons are: "Channel select", "Stage select", "Find, Trigger on, or Reset condition", "Select term", "Define term", and "Return to previous menu".

As you set stage, term, and channel definitions for the sequence trigger, these settings will be shown in the waveform area of the display.

Define the Find: stage

- 1 Press the **Stage** softkey and select **Find:**.

Find: is the first stage in the trigger sequence. When you select the **Stage Find** softkey, the next softkey to the right will display **Find:** and give you a list of the terms you can define for the Find stage. The Find stage can be set to one of the following conditions:

- **Pattern 1 Entered** – A pattern is entered on the last edge that makes the pattern true (logical AND).
- **Pattern 1 Exited** – A pattern is exited on the first edge that makes the pattern false (logical NAND).
- **Edge 1**
- **Pattern 1 and Edge 1**

- 2 Press the **Find:** softkey and select the Find stage condition.

- 3 To define the term(s) used in the Find stage, press the **Term** softkey and select the pattern and/or edge term displayed in the **Find:** softkey.

- 4 If you select a pattern term, each channel in the pattern must be set to a **H** (high), **L** (low), or **X** (don't care).

- a Press the **Channel** softkey (or rotate the Entry knob on mixed-signal oscilloscopes) to select the channel.

As you select a channel, the channel is highlighted in the selected pattern list shown in the waveform area and is also shown in the upper-right corner of the display next to “**Seq**”

- b Press the **L H X** softkey to set a level for the channel.

- **H** sets the pattern to high on the selected channel. A high is a voltage level that is greater than the channel's trigger level or threshold level.
- **L** sets the pattern to low on the selected channel. A low is a voltage level that is less than the channel's trigger level or threshold level.

- **X** sets the pattern to don't care on the selected channel. Any channel set to don't care is ignored and is not used as part of the pattern. If all channels in the pattern are set to don't care, the oscilloscope will not trigger.

Adjust the trigger level for the selected analog channel by turning the Trigger Level knob. Press the **D15 Thru D0** key and select **Thresholds** to set the threshold level for digital channels. The value of the trigger level or digital threshold is displayed in the upper-right corner of the display.

- Repeat for all channels in the pattern.
- If you select an edge term, one channel must be set to a rising edge or a falling edge. All other channel edges will be set to don't care (X).
 - Press the **Channel** softkey (or rotate the Entry knob on mixed-signal oscilloscopes) to select the channel.

As you select a channel, the channel is highlighted in the selected pattern list shown in the waveform area.
 - Then press the **↕** **↘** **X** softkey to select rising edge or falling edge. All other channels will be defaulted to don't care (X).

If you want to reassign an edge to a different channel, repeat the above step. The value of the original channel edge will be defaulted to **X** (don't care).

If the term(s) used in the "Find:" Sequence Stage condition are set to "don't care," the oscilloscope will not trigger. At least one term in the stage must be set to a value other than X (don't care).

Define the Trigger on: stage

- Press the **Stage** softkey and select **Trigger on:**.

Trigger on: is the next stage in the trigger sequence. When you select the **Stage Trigger on:** softkey, the next softkey to the right will display **Trigger:** and give you a list of the terms you can define for the **Trigger on:** stage. The **Trigger on:** stage can be set to one of the following conditions:

- **Pattern 2 Entered** – A pattern is entered on the last edge that makes the pattern true (logical AND).
 - **Pattern 2 Exited** – A pattern is exited on the first edge that makes the pattern false (logical NAND).
 - **Edge 2**
 - **Pattern 2 and Edge 2**
 - **Nth Edge 2**
 - **Nth Edge 2 (no re-find)**
- 2 Press the **Trigger:** softkey and select a stage to trigger on.
 - 3 To define the term(s) used in the Trigger on: stage, press the **Term** softkey and select the pattern or edge term displayed in the **Trigger:** softkey.
 - 4 If you select a pattern term, each channel in the pattern must be set to a **H** (high), **L** (low), or **X** (don't care).
 - a Press the **Channel** softkey (or rotate the Entry knob on mixed-signal oscilloscopes) to select the channel.
 - b Press the **L H X** softkey to set a level for the channel.
 - c Repeat for all channels in the pattern.
 - 5 If you select an edge term, one channel must be set to a rising edge or a falling edge. All other channel edges will be set to don't care (**X**).
 - a Press the **Channel** softkey (or rotate the Entry knob on mixed-signal oscilloscopes) to select the channel.

The channel you select is shown in the upper-right corner of the display next to “**Seq**”.
 - b Then press the **↕ ↘ X** softkey to select rising edge or falling edge. All other channel edges will be defaulted to don't care.
 - 6 When you set a Trigger on: condition to trigger on Edge 2, you can also select which occurrence of Edge 2 to trigger on.
 - a Make sure **Nth Edge 2** or **Nth Edge 2 (no re-find)** is selected in the **Trigger:** softkey.

When **Nth Edge 2** is selected, if the Find event occurs again before the Count (N) event is satisfied, Count (N) will be reset to zero.

When **Nth Edge 2 (no re-find)** is selected, if the Find event occurs again before the Count (N) event is satisfied, the Count (N) is not reset to zero.

- b Press the **Term** softkey and select **Count (N)**.
- c Press the **N** softkey, then turn the Entry knob to set the number of edges to wait before triggering.

N can be set from 1 to 10,000.

If the term(s) used in the "Trigger on:" Sequence Stage condition are set to "don't care," the oscilloscope will not trigger. At least one term in the stage must be set to a value other than X (don't care).

Define the optional Reset on: stage

- 1 Press the **Stage** softkey and select **Reset on:**.

Reset on: is the last stage in the trigger sequence. When you select the **Stage Reset on:** softkey, the next softkey to the right will display **Reset:** and give you a list of the terms you can define for the Reset on: stage. The Reset on: stage can be set to one of the following conditions:

- **No Reset** – Resets on the find condition.
- **Pattern 1 (or 2) Entered** – A pattern is entered on the last edge that makes the pattern true (logical AND).
- **Pattern 1 (or 2) Exited** – A pattern is exited on the first edge that makes the pattern false (logic NAND).
- **Edge 1 (or 2)**
- **Pattern 1 and Edge 1**
- **Timeout**

Terms that are grayed-out are not valid in the reset stage.

- 2 Press the **Reset:** softkey and select a term to reset on.
- 3 Press the **Term** softkey and select the pattern, edge, or timeout term displayed in the **Reset:** softkey.
- 4 If you select **No Reset**, no reset stage will be defined.

- 5 If you select a pattern term, each channel in the pattern must be set to a **H** (high), **L** (low), or **X** (don't care).
 - a Press the **Channel** softkey (or rotate the Entry knob on mixed-signal oscilloscopes) to select the channel.
 - b Press the **L H X** softkey to set a level for the channel.
 - c Repeat for all channels in the pattern.
- 6 If you select an edge term, one channel must be set to a rising edge or a falling edge. All other channel edges will be set to don't care (X).
 - a Press the **Channel** softkey (or rotate the Entry knob on mixed-signal oscilloscopes) to select the channel.
 - b Then press the **↕ ↘ X** softkey to select rising edge or falling edge. All other channel edges will be defaulted to don't care.
- 7 If you select the **Timeout** term, you will need to set a timeout value.
 - a Press the **Term** softkey and select **Timeout**.
 - b Press the **Timeout** softkey, then turn the Entry knob to set the timeout value.

Timeout can be set from 10 ns to 10 seconds. The timer starts when the Find condition has been met. If the timer is running and another Find condition occurs, the timer will restart from time zero.

Adjust the trigger level

- For analog channels, adjust the trigger level for the selected analog channel by turning the Trigger Level knob.
- To set the threshold level for digital channels, press the **D15 Thru D0** key and select **Thresholds**.

The value of the trigger level or digital threshold is displayed in the upper-right corner of the display.

To use SPI triggering

NOTE

For SPI decode information see page 306.

Serial Peripheral Interface (SPI) trigger setup consists of connecting the oscilloscope to a clock, data, and framing signal. You can then trigger on a data pattern that occurs at the start of a frame. The serial data string can be specified to be from 4 to 32 bits long.

When you press the **Settings** softkey, a graphic will be displayed showing the current state of the frame signal, clock slope, number of data bits, and data bit values. Press the **Signals** softkey in the **Settings** menu to see the current source channels for the clock, data, and frame signals.

- Press the **More** key in the Trigger section of the front panel, rotate the Entry knob until **SPI** is displayed in the **Trigger** softkey, then press the **Settings** softkey to display the SPI trigger menu.

Currently selected Clock, Framing, or Data channel

Trigger level or threshold

SPI trigger

0.000s 200% Auto SPI 1.40V

Graphic showing current state of the SPI trigger setup

Data string values

~CS

CLK

DATA

Bit 0 Bit 1 Bit N-1 Bit N

Data: XXXX XXXX

SPI Trigger Menu

Signals

#Bits 8

Bit 0

L H X

Set all Bits X

Assign channels

databits in string

Data bit select

Data bit value

Set all data bits to value

Return to previous menu

Assign source channels to the clock, data, and frame signals

- 1 Press the **Signals** softkey to access SPI trigger settings for clock source and slope, data source, and frame type and source.

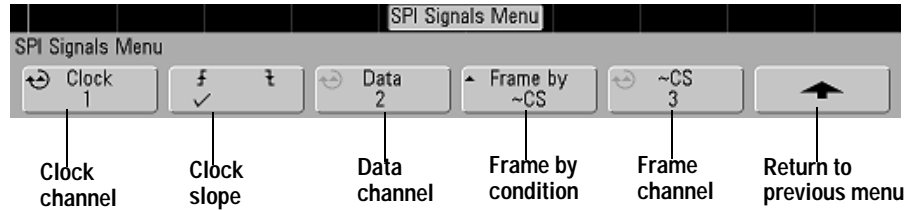

- 2 Press the **Label** key on the front panel to switch labels on.
- 3 Press the **Clock** softkey or turn the Entry knob to select the channel connected to the SPI serial clock line.

As you press the **Clock** softkey (or rotate the Entry knob on mixed-signal oscilloscopes), the **CLK** label for the source channel is automatically set and the channel you select is shown in the upper-right corner of the display next to “**SPI**”.

Adjust the trigger level for the selected analog channel by turning the Trigger Level knob. Press the **D15 Thru D0** key and select **Thresholds** to set the threshold level for digital channels. The value of the trigger level or digital threshold is displayed in the upper-right corner of the display.

- 4 Press the slope softkey (↑ ↓) to select rising edge or falling edge for the selected Clock source.

This determines which clock edge the oscilloscope will use to latch the serial data. When you press the slope softkey, the graphic shown on the display changes to show the current state of the clock signal.

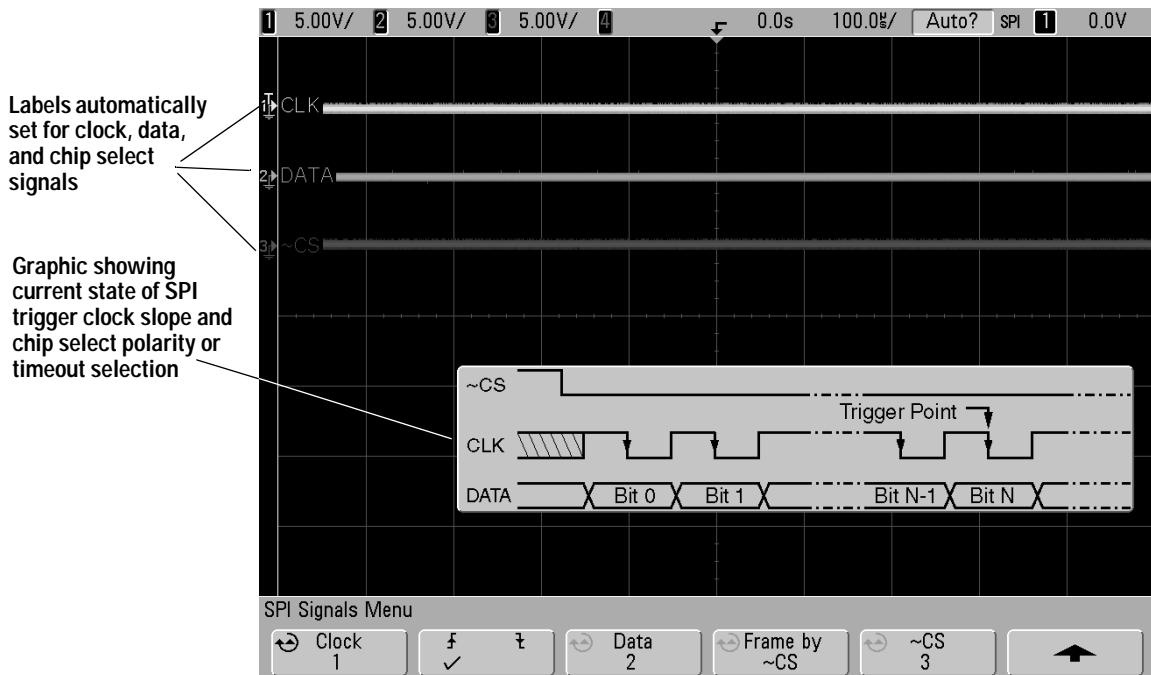

- 5 Press the **Data** softkey or turn the Entry knob to select the channel that is connected to the SPI serial data line. (If the channel you selected is off, switch it on.)

As you press the **Data** softkey (or rotate the Entry knob on mixed-signal oscilloscopes), the **DATA** label for the source channel is automatically set and the channel you select is shown in the upper-right corner of the display next to “**SPI**”.

Adjust the trigger level for the selected analog channel by turning the Trigger Level knob. Press the **D15 Thru D0** key and select **Thresholds** to set the threshold level for digital channels. The value of the trigger level or digital threshold is displayed in the upper-right corner of the display.

- 6 Press the **Frame by** softkey to select a framing signal that the oscilloscope will use for determining which clock edge is the first clock edge in the serial stream.

You can set the oscilloscope to trigger during a high chip select (**CS**), a low chip select (**~CS**), or after a **Timeout** period during which the clock signal has been idle.

- If the framing signal is set to **CS** (or **~CS**), the first clock edge as defined, rising or falling, seen after the **CS** (or **~CS**) signal transitions from low to high (or high to low) is the first clock in the serial stream.

Chip Select – Press the **CS** or **~CS** softkey or turn the Entry knob to select the channel that is connected to the SPI frame line. The label (**~CS** or **CS**) for the source channel is automatically set. The data pattern and the clock transition must occur during the time when the framing signal is valid. The framing signal must be valid for the entire data pattern.

As you press the **CS** or **~CS** softkey (or rotate the Entry knob on mixed-signal oscilloscopes), the **CS** or **~CS** label for the source channel is automatically set and the channel you select is shown in the upper-right corner of the display next to “**SPI**”. When you press the **Frame by** softkey, the graphic shown on the previous page changes to show timeout selection or the current state of the chip select signal.

Adjust the trigger level for the selected analog channel by turning the Trigger Level knob. Press the **D15 Thru D0** key and select **Thresholds** to set the threshold level for digital channels. The value of the trigger level or digital threshold is displayed in the upper-right corner of the display.

- If the framing signal is set to **Timeout**, the oscilloscope generates it’s own internal framing signal after it sees inactivity on the serial clock line.

Clock Timeout – Select **Clock Timeout** in the **Frame by** softkey, then select the **Timeout** softkey and turn the Entry knob to set the minimum time that the Clock signal must be idle (not transitioning) before the oscilloscope will search for the Data pattern on which to trigger. When you press the **Frame by** softkey, the graphic shown on the previous page changes to show timeout selection or the current state of the chip select signal.

The Timeout value can be set anywhere from 100 ns to 10 s.

- 7 Press the up-arrow softkey to return to the previous menu.

Set up the number of bits in the serial data string and set values for those data bits

- 1 Press the **#Bits** softkey, and turn the Entry knob to set the number of bits (**#Bits**) in the serial data string. The number of bits in the string can be set anywhere from 4 bits to 32 bits. The data values for the serial string are displayed in the Data string in the waveform area.
- 2 Turn the Entry knob to select a specific data bit in the serial string as shown in the **Bit** softkey.

As you rotate the Entry knob, the bit is highlighted in the Data string shown in the waveform area.

- 3 Press the **L H X** softkey to set the bit selected in the **Bit** softkey to **L** (low), **H** (high), or **X** (don't care).

Repeat steps 2 and 3 to assign values for all bits.

Resetting all bits in the serial data string to one value

- To reset all of the bit values in the serial data string to one value (L, H, or X):
 - a Press the **L H X** softkey to select your reset bit value.
 - b Press the **Set all Bits** softkey to reset the data string to the selected value.

To use TV triggering

TV triggering can be used to capture the complicated waveforms of most standard and high-definition analog video signals. The trigger circuitry detects the vertical and horizontal interval of the waveform and produces triggers based on the TV trigger settings you have selected.

The oscilloscope's MegaZoom III technology gives you bright, easily viewed displays of any part of the video waveform. Analysis of video waveforms is simplified by the oscilloscope's ability to trigger on any selected line of the video signal.

- 1 Press the **More** key in the Trigger section of the front panel. If **TV** is not selected, rotate the Entry knob until **TV** is displayed in the **Trigger** softkey, then press the **Settings** softkey to display TV trigger menu.

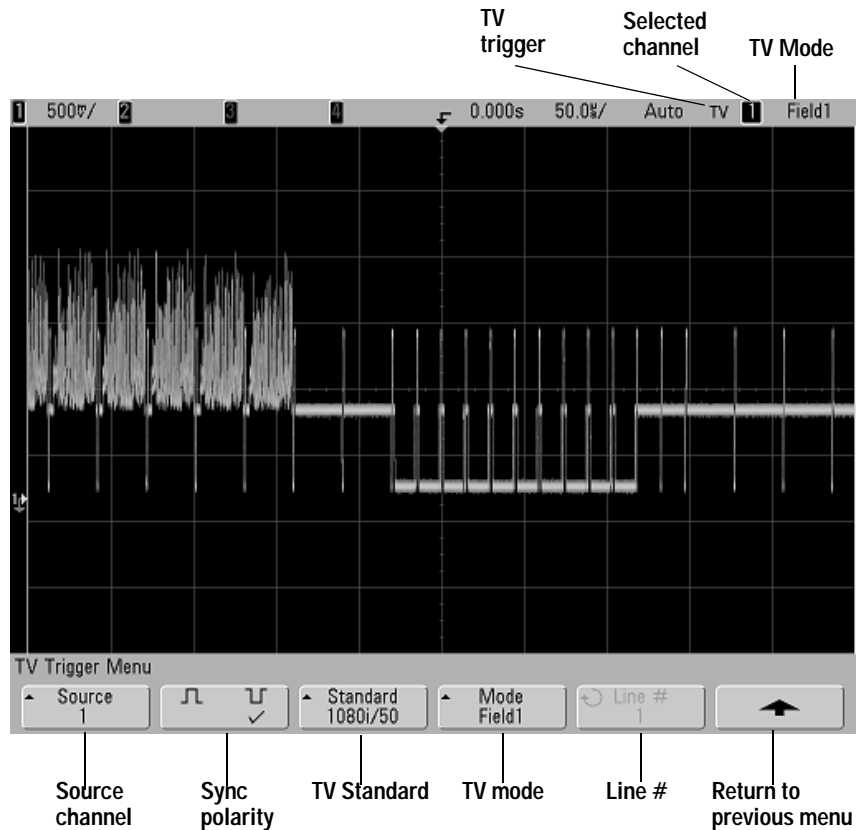

- 2 Press the **Source** softkey and select any analog channel as the TV trigger source.

The selected trigger source is displayed in the upper-right corner of the display. Turning the Trigger **Level** knob does not change the trigger level because the trigger level is automatically set to the sync pulse. Trigger coupling is automatically set to **TV** in the Trigger **Mode/Coupling** menu.

Provide Correct Matching

Many TV signals are produced from 75 Ω sources. To provide correct matching to these sources, a 75 Ω terminator (such as an Agilent 11094B) should be connected to the oscilloscope input.

- 3 Press the sync polarity softkey to set the TV trigger to either positive (\square) or negative (\square) sync polarity.
- 4 Press the **Standard** softkey to set the TV standard.

The oscilloscope supports triggering on the following television (TV) and video standards.

Standard	Type	Sync Pulse
NTSC	Interlaced	Bi-level
PAL	Interlaced	Bi-level
PAL-M	Interlaced	Bi-level
SECAM	Interlaced	Bi-level
Generic	Interlaced/Progressive	Bi-level/Tri-level
EDTV 480p/60	Progressive	Bi-level
HDTV 720p/60	Progressive	Tri-level
HDTV 1080p/24	Progressive	Tri-level
HDTV 1080p/25	Progressive	Tri-level
HDTV 1080i/50	Interlaced	Tri-level
HDTV 1080i/60	Interlaced	Tri-level

- 5 Press the **Mode** softkey to select the portion of the video signal that you would like to trigger on.

The TV trigger modes available are:

- **Field1** and **Field2** – Trigger on the rising edge of the first serration pulse of field 1 or field 2 (interlaced standards only).
- **All Fields** – Trigger on the rising edge of the first pulse in the vertical sync interval (not available in Generic mode).
- **All Lines** – Trigger on all horizontal sync pulses.

- **Line** – Trigger on the selected line # (EDTV and HDTV standards only).
 - **Line: Field1** and **Line:Field2** – Trigger on the selected line # in field 1 or field 2 (interlaced standards only except 1080i).
 - **Line: Alternate** – Alternately trigger on the selected line # in field 1 and field 2 (NTSC, PAL, PAL-M, and SECAM only).
 - **Vertical** – Trigger on the rising edge of the first serration pulse or approximately 70 μ s after the start of vertical sync, whichever occurs first (only available in Generic mode).
 - **Count: Vertical** – Counts falling edges of sync pulses; triggers on the selected count number (only available in Generic mode).
- 6 If you select a line # mode, press the **Line #** softkey, then rotate the Entry knob to select the line number on which you want to trigger.
 - 7 When using the Generic standard and you select a line # mode or **Count:Vertical**, press the **Count #** softkey and rotate the Entry knob to select the desired count number.

Listed below are the line (or count) numbers per field for each video standard.

Table 11 Line (or count for Generic) numbers per field for each non-HDTV/EDTV video standard

Video standard	Field 1	Field 2	Alt Field
NTSC	1 to 263	1 to 262	1 to 262
PAL	1 to 313	314 to 625	1 to 312
PAL-M	1 to 263	264 to 525	1 to 262
SECAM	1 to 313	314 to 625	1 to 312
Generic	1 to 1024	1 to 1024	1 to 1024 (vertical)

Line Number Represents Count

In **Generic** mode, the line number represents the number of a count instead of a real line number. This is reflected in the label in the softkey changing from **Line** to **Count**. In the **Mode** softkey selections, **Line:Field 1**, **Line:Field 2** and **Count:Vertical** are used to indicate where the counting starts. For an interlaced video signal, the counting starts from the rising edge of the first vertical serration pulse of Field 1 and/or Field 2. For a non-interlaced video signal, the counting starts after the rising edge of the vertical sync pulse.

Table 12 Line numbers for each EDTV/HDTV video standard

EDTV 480p/60	1 to 525
HDTV 720p/60	1 to 750
HDTV 1080p/24	1 to 1125
HDTV 1080p/25	1 to 1125
HDTV 1080i/50	1 to 1125
HDTV 1080i/60	1 to 1125

Example exercises

The following are exercises to familiarize you with TV triggering. These exercises use the NTSC video standard.

To trigger on a specific line of video

TV triggering requires greater than 1/2 division of sync amplitude with any analog channel as the trigger source. Turning the trigger **Level** knob in TV trigger does not change the trigger level because the trigger level is automatically set to the sync pulse tips.

One example of triggering on a specific line of video is looking at the vertical interval test signals (VITS), which are typically in line 18. Another example is closed captioning, which is typically in line 21.

- 1 Press the **Trigger More** key, then press the **TV** softkey.
- 2 Press the **Settings** softkey, then press the **Standard** softkey to select the appropriate TV standard (NTSC).
- 3 Press the **Mode** softkey and select the TV field of the line you want to trigger on. You can choose **Line:Field1**, **Line:Field2**, or **Line:Alternate**.
- 4 Press the **Line #** softkey and select the number of the line you want to examine.

Alternate Triggering

If **Line:Alternate** is selected, the oscilloscope will alternately trigger on the selected line number in Field 1 and Field 2. This is a quick way to compare the Field 1 VITS and Field 2 VITS or to check for the correct insertion of the half line at the end of Field 1.

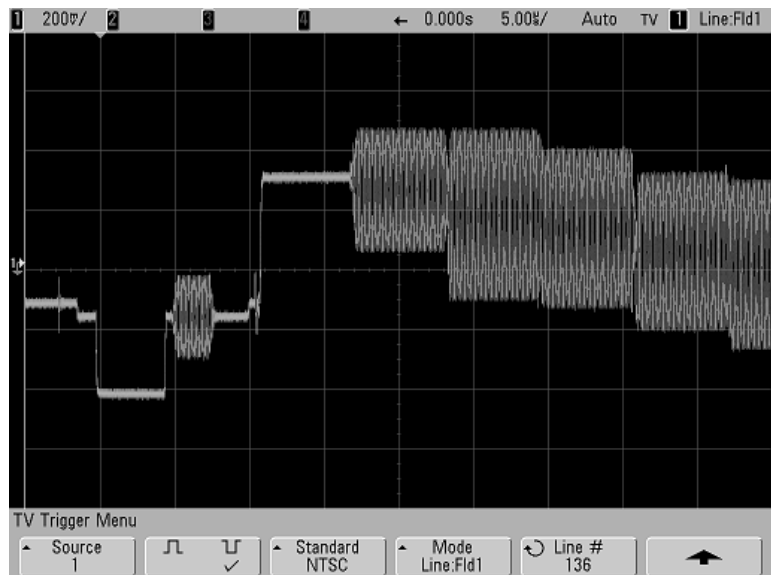

Figure 18 Example: Triggering on Line 136

To trigger on all sync pulses

To quickly find maximum video levels, you could trigger on all sync pulses. When **All Lines** is selected as the TV trigger mode, the oscilloscope will trigger on all horizontal sync pulses.

- 1 Press the **Trigger More** key, then press the **TV** softkey.
- 2 Press the **Settings** softkey, then press the **Standard** softkey to select the appropriate TV standard.
- 3 Press the **Mode** softkey and select **All Lines**.

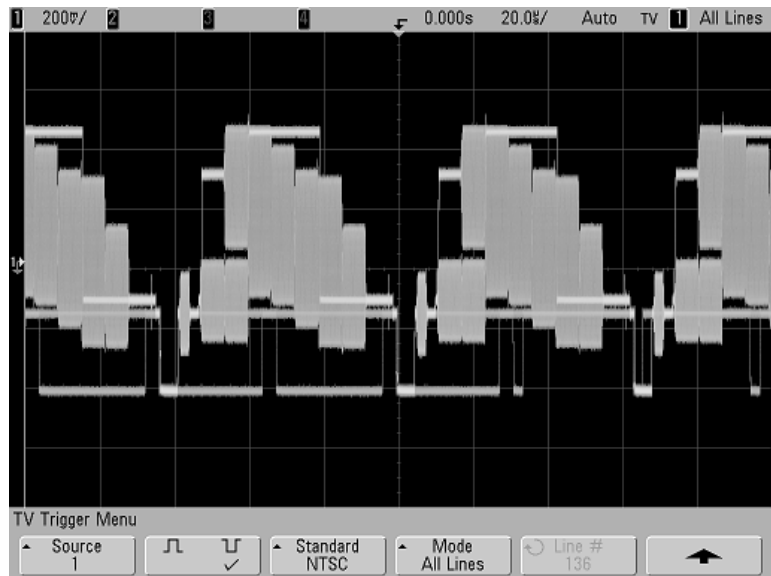

Figure 19 Triggering on All Lines

To trigger on a specific field of the video signal

To examine the components of a video signal, trigger on either Field 1 or Field 2 (available for interleaved standards). When a specific field is selected, the oscilloscope triggers on the rising edge of the first serration pulse in the vertical sync interval in the specified field (1 or 2).

- 1 Press the **Trigger More** key, then press the **TV** softkey.
- 2 Press the **Settings** softkey, then press the **Standard** softkey to select the appropriate TV standard.
- 3 Press the **Mode** softkey and select **Field1** or **Field2**.

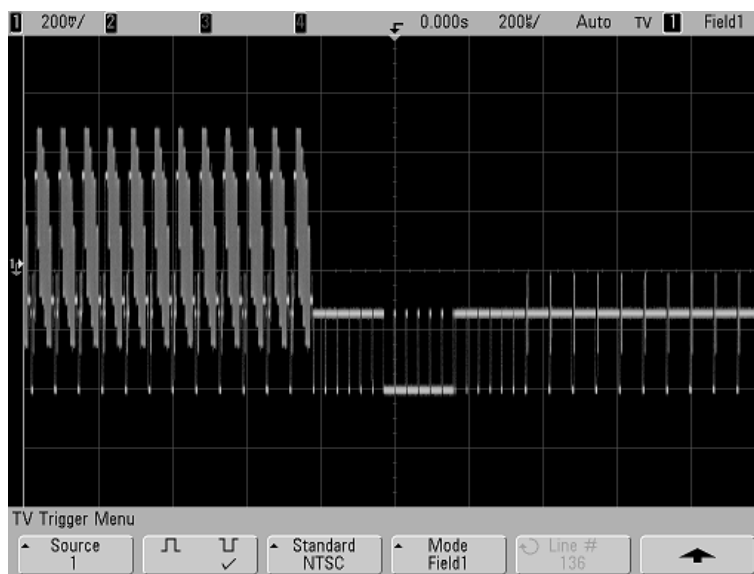

Figure 20 Triggering on Field 1

To trigger on all fields of the video signal

To quickly and easily view transitions between fields, or to find the amplitude differences between the fields, use the All Fields trigger mode.

- 1 Press the **Trigger More** key, then press the **TV** softkey.
- 2 Press the **Settings** softkey, then press the **Standard** softkey to select the appropriate TV standard.
- 3 Press the **Mode** softkey and select **All Fields**.

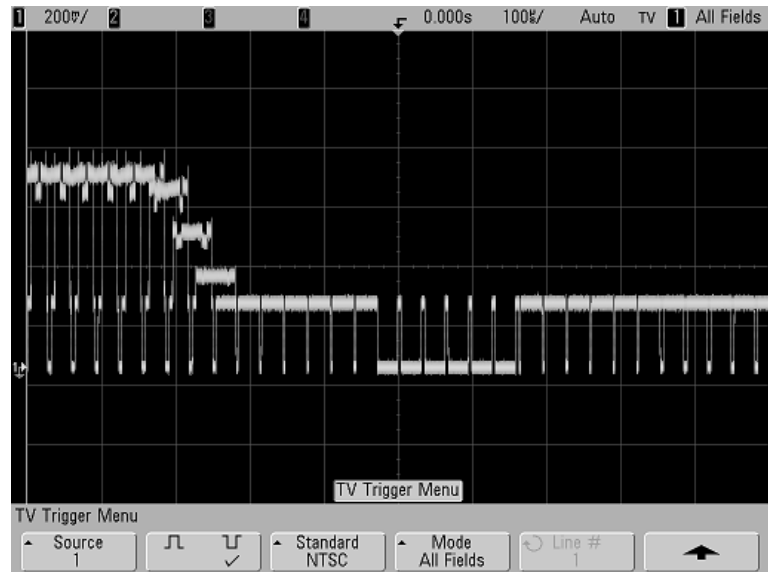

Figure 21 Triggering on All Fields

To trigger on odd or even fields

To check the envelope of your video signals, or to measure worst case distortion, trigger on the odd or even fields. When Field 1 is selected, the oscilloscope triggers on color fields 1 or 3. When Field 2 is selected, the oscilloscope triggers on color fields 2 or 4.

- 1 Press the **Trigger More** key, then press the **TV** softkey.
- 2 Press the **Settings** softkey, then press the **Standard** softkey to select the appropriate TV standard.
- 3 Press the **Mode** softkey and select **Field1** or **Field2**.

The trigger circuits look for the position of the start of Vertical Sync to determine the field. But this definition of field does not take into consideration the phase of the reference subcarrier. When Field 1 is selected, the trigger system will find any field where the vertical sync starts on Line 4. In the case of NTSC video, the oscilloscope will trigger on color field 1 alternating with color field 3 (see the following figure). This setup can be used to measure the envelope of the reference burst.

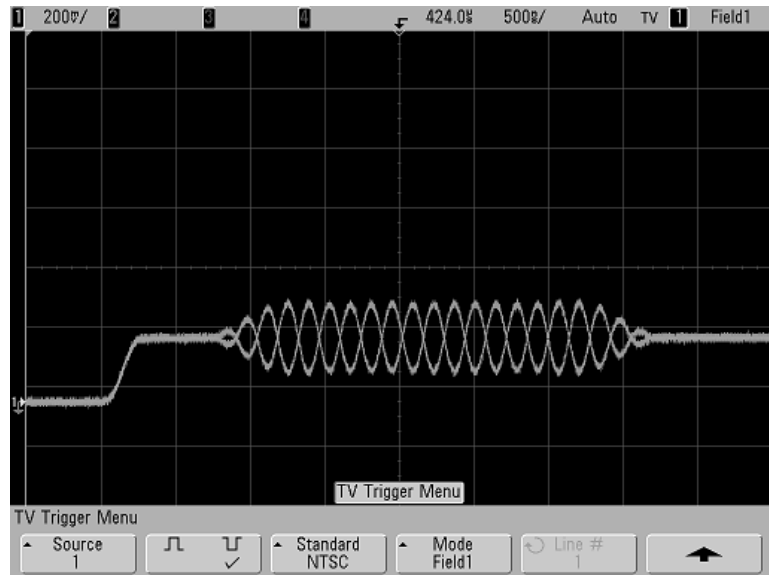

Figure 22 Triggering on Color Field 1 Alternating with Color Field 3

If a more detailed analysis is required, then only one color field should be selected to be the trigger. You can do this by using the **TV Holdoff** softkey in the trigger More Trigger Menu when the trigger type is set to **TV**. Press the **TV Holdoff** softkey and use the Entry knob to adjust the holdoff in half-field increments until the oscilloscope triggers on only one phase of the color burst.

A quick way to synchronize to the other phase is to briefly disconnect the signal and then reconnect it. Repeat until the correct phase is displayed.

When holdoff is adjusted using the **TV Holdoff** softkey and the Entry knob, the corresponding holdoff time will be displayed in the **Mode/Coupling** menu.

4 Triggering the Oscilloscope

Table 13 Half-field holdoff time

Standard	Time
NTSC	8.35 ms
PAL	10 ms
PAL-M	10 ms
SECAM	10 ms
Generic	8.35 ms
EDTV 480p/60	8.35 ms
HDTV 720p/60	8.35 ms
HDTV 1080p/24	20.835 ms
HDTV 1080p/25	20 ms
HDTV 1080i/50	10 ms
HDTV 1080i/60	8.35 ms

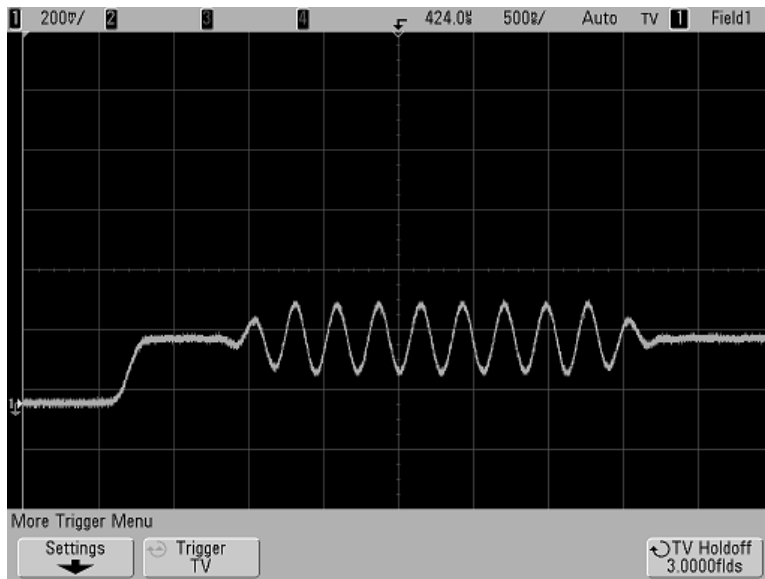

Figure 23 Using TV Holdoff to Synchronize to Color Field 1 or 3 (Field 1 mode)

To use UART/RS232 triggering

NOTE

For UART/RS232 decode setup see page 336.

To trigger on a UART (Universal Asynchronous Receiver/Transmitter) signal connect the oscilloscope to the Rx and Tx lines and set up a trigger condition. RS232 (Recommended Standard 232) is one example of a UART protocol.

- 1 Press the **More** key in the Trigger section of the front panel. Rotate the Entry knob until **UART/RS232** is displayed in the **Trigger** softkey
- 2 Press the **Settings** softkey to display the UART/RS232 trigger menu.

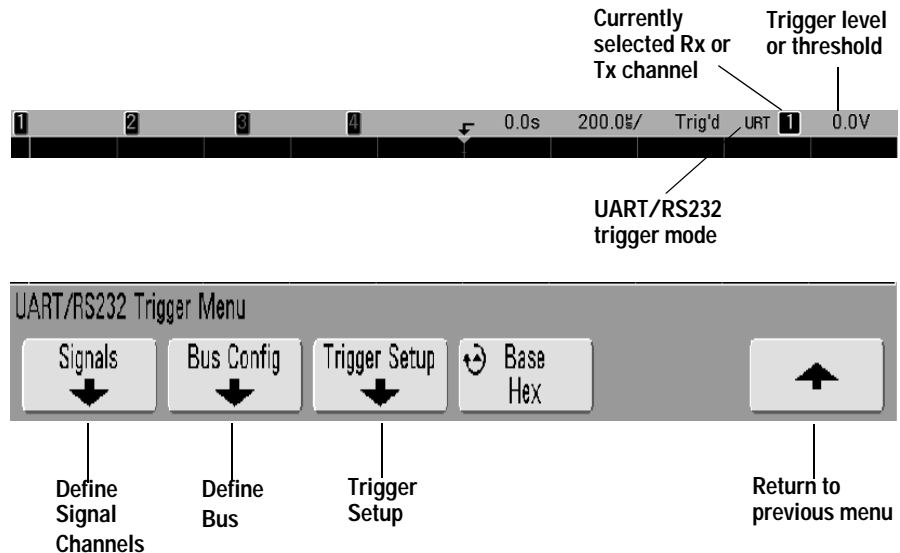

- 3 Press the **Signals** softkey to display the UART/RS232 signals menu.

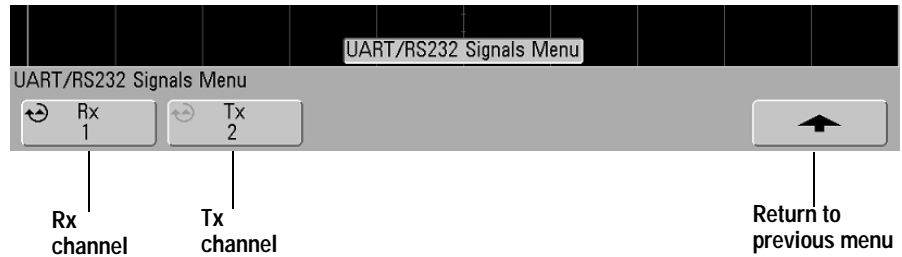

- 4 Connect an oscilloscope channel to the Rx signal in the circuit under test (the target system), then press the **Rx** softkey and rotate the Entry knob to select the channel.

As you press the **Rx** softkey (or rotate the Entry knob on mixed-signal oscilloscopes), the channel you select is shown in the upper-right corner of the display next to “**URT**”.
- 5 To display the **Rx** label, press the **Label** key on the front panel to switch labels on.
- 6 Make sure the trigger or threshold levels are set to the middle of the signal:
 - For analog channels, turn the Trigger Level knob.
 - For digital channels, press the **D15-D0** key and the **Thresholds** softkey to access the threshold level setting softkeys.
 The value of the trigger level or digital threshold is displayed in the upper-right corner of the display.
- 7 Repeat these two steps for the Tx signal.
- 8 Press the up arrow key to return to the previous menu.
- 9 Press the **Bus Config** softkey and set the following parameters.
 - a **#Bits**: Set the number of bits in the UART/RS232 words to match your target system (selectable from 5-9 bits).
 - b **Parity**: Choose odd, even, or none, based on your target system.
 - c **Baud**: Press the **Baud Rate** softkey, then press the **Baud** softkey and select a baud rate to match the signal in your

target system. If the desired baud rate is not listed, select **User Defined** on the Baud softkey, then select the desired baud rate using the **User Baud** softkey. You can set the UART baud rate from 1.2 kb/s to 3.0000 Mb/s in increments of 100 b/s.

- d **Polarity:** Select idle low or idle high to match your target system's state when at idle. For RS232 select idle low.
 - e **Bit Order:** Select whether the most significant bit (MSB) or the least significant bit (LSB) is presented after the start bit in the signal from your target system. For RS232 select LSB.
- 10 Press the up arrow key to return to the previous menu.
 - 11 Press the **Base** softkey. Use this key to select Hex or ASCII as the base displayed on the Data softkey in the UART/RS232 Trigger Setup Menu. Note that the setting of this softkey does not affect the selected base of the decode display.
 - 12 Press the **Trigger Setup** softkey and set up the desired trigger condition.
 - **Rx Start Bit:** The oscilloscope triggers when a start bit occurs on Rx.
 - **Rx Stop Bit:** Triggers when a stop bit occurs on Rx. The trigger will occur on the first stop bit. This is done automatically whether the target system uses 1, 1.5, or 2 stop bits. You do not need to specify the number of stop bits used by the target system.
 - **Rx Data:** Triggers on a data byte that you specify. For use when the target system data words are from 5 to 8 bits in length (no 9th (alert) bit).
 - **Rx 1:Data:** For use when the target system data words are 9 bits in length including the alert bit (the 9th bit). Triggers only when the 9th (alert) bit is 1. The specified data byte applies to the least significant 8 bits (excludes the 9th (alert) bit).
 - **Rx 0:Data:** For use when the target system data words are 9 bits in length including the alert bit (the 9th bit). Triggers only when the 9th (alert) bit is 0. The specified data byte applies to the least significant 8 bits (excludes the 9th (alert) bit).

- **Rx X:Data:** For use when the target system data words are 9 bits in length including the alert bit (the 9th bit). Triggers on a data byte that you specify regardless of the value of the 9th (alert) bit. The specified data byte applies to the least significant 8 bits (excludes the 9th (alert) bit).
- Similar choices are available for Tx.
- **Rx or Tx Parity Error:** Triggers on a parity error based on the parity you have set in the Bus Configuration Menu.

- 13** If you choose a trigger condition that includes “**Data**” in its description (for example: **Rx Data**) then press the **Data is** softkey and choose an equality qualifier. You can choose equal to, not equal to, less than, or greater than a specific data value.
- 14** Use the **Data** softkey to choose the data value for your trigger comparison. This works in conjunction with the **Data is** softkey.
- 15** Optional: The **Burst** softkey lets you trigger on the Nth frame (1-4096) after an idle time you select. All trigger conditions must be met for the trigger to occur.
- 16** If **Burst** is selected, an idle time (1 μ s to 10 s) can be specified so that the oscilloscope will look for a trigger condition only after the idle time has past. Press the **Idle** softkey and rotate the Entry knob to set an idle time.

17 Remember to set the trigger mode to Normal (press **Mode/Coupling**→**Mode**→**Normal**) to prevent Auto Triggering.

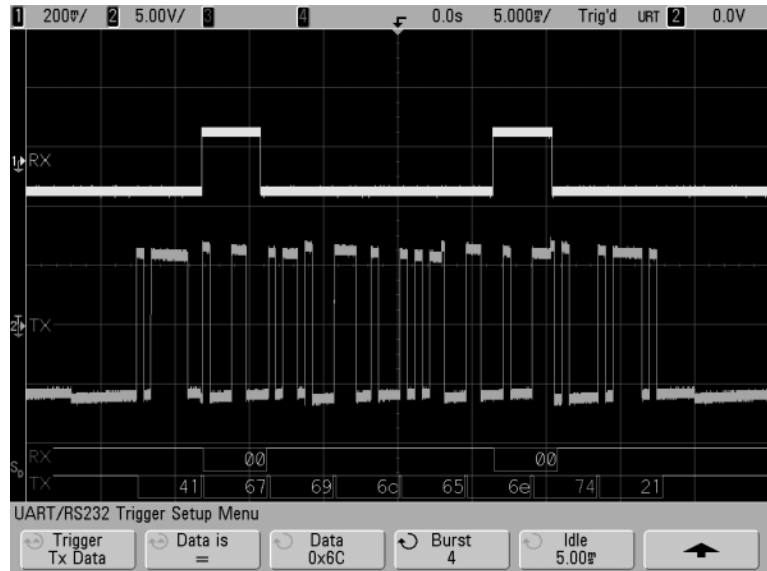

To use USB triggering

USB trigger will trigger on a Start of Packet (SOP), End of Packet (EOP) signal, Reset Complete (RC), Enter Suspend (Suspend), or Exit Suspend (Exit Sus) on the differential USB data lines (D+ and D-). USB Low Speed and Full Speed are supported by this trigger.

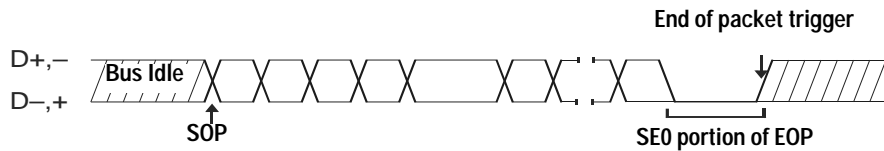

- 1 Press the **More** key in the Trigger section of the front panel, rotate the Entry knob until **USB** is displayed in the **Trigger** softkey, then press the **Settings** softkey to display USB trigger menu.

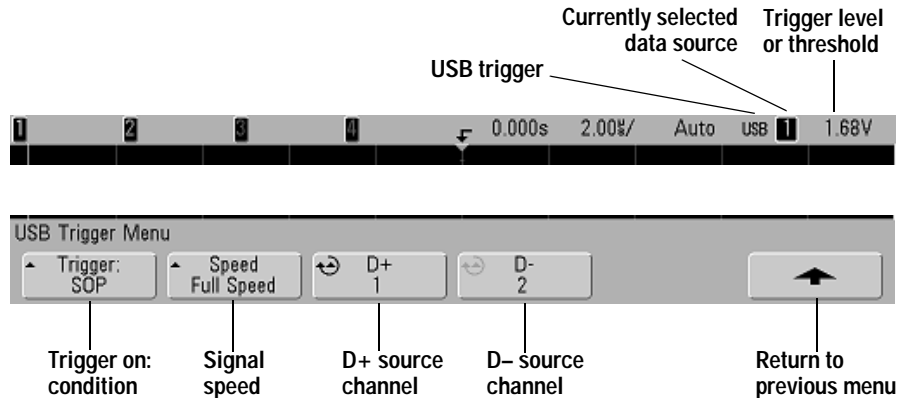

- 2 Press the **Speed** softkey to select the speed of the transaction being probed.
You may select Low Speed (1.5 Mb/s) or Full Speed (12 Mb/s).
- 3 Press the **D+** and **D-** softkeys to select the channel connected to the USB signal D+ and D- lines. The **D+** and **D-** labels for the source channels are automatically set.

As you press the **D+** or **D-** softkey (or rotate the Entry knob on mixed-signal oscilloscopes), the **D+** and **D-** label for the source channel is automatically set and the channel you select is shown in the upper-right corner of the display next to “**USB**”.

Adjust the trigger level for the selected analog channel by turning the Trigger Level knob. Press the **D15 Thru D0** key and select **Thresholds** to set the threshold level for digital channels. The value of the trigger level or digital threshold is displayed in the upper-right corner of the display.

- 4 Press the **Trigger**: softkey to select where the USB trigger will occur:
 - **SOP** (Start of Packet) – triggers at the Sync bit at the beginning of the packet.
 - **EOP** (End of Packet) – triggers at the end of the SE0 portion of the EOP.
 - **RC** (Reset Complete) – triggers when SE0 is > 10 ms.
 - **Suspend** (Enter Suspend) – triggers when the bus is idle > 3 ms.
 - **Exit Sus** (Exit Suspend) – triggers when exiting an idle state > 10 ms. This is used to see the suspend/resume transition.

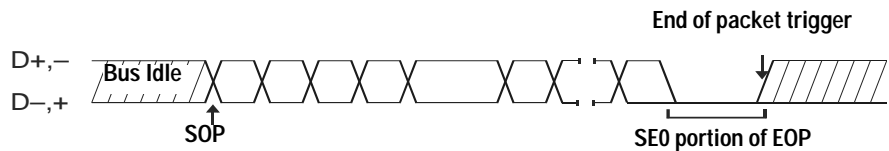

The Trigger Out connector

You can select one of the following signals to be output at the TRIG OUT connector on the rear panel of the oscilloscope:

- Triggers
- Source frequency
- Source frequency/8 (except 100 MHz BW models)
- Mask test pass/fail (see “Mask Test Trigger Output” on page 291.)

Triggers

This is the default selection. In this mode, a rising edge is output each time the oscilloscope triggers. This rising edge is delayed 17 ns from the oscilloscope’s trigger point. The output level is 0-5 V into an open circuit, and 0-2.5 V into 50 Ω .

Source frequency

This mode is only available when the oscilloscope is set to positive or negative edge trigger on a front-panel source (analog channel or the external input of a 2-channel oscilloscope). In this mode, the TRIG OUT BNC is connected to the output of the trigger comparator. The output level is 0-580 mV into an open circuit, and 0-290 mV into 50 Ω . The maximum frequency output is 350 MHz due to the bandwidth limitation of the TRIG OUT BNC amplifier. This selection is useful for driving an external frequency counter.

Source frequency/8

This selection produces the same signal as described in Source frequency except the output frequency is one-eighth of the trigger comparator output frequency. This mode is useful when your input signal is faster than 350 MHz. This selection is not available on 100 MHz bandwidth model oscilloscopes.

The Trigger Out connector also provides the User Cal signal. See “User Calibration” on page 113.

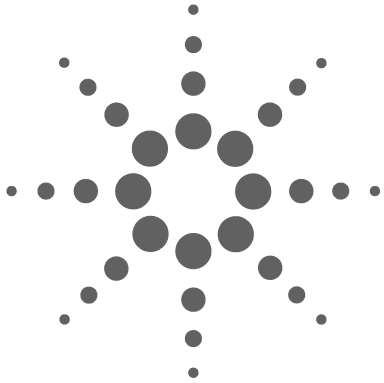

5 Making Measurements

To use the XY horizontal mode 214

Math Functions 219

Cursor Measurements 238

Automatic Measurements 246

Measurement Statistics 249

Measurement Definitions 254

Post Acquisition Processing

In addition to changing display parameters after the acquisition, you can perform all of the measurements and math functions after the acquisition. Measurements and math functions will be recalculated as you pan and zoom and turn channels on and off. As you zoom in and out on a signal using the horizontal sweep speed knob and vertical volts/division knob, you affect the resolution of the display. Because measurements and math functions are performed on displayed data, you affect the resolution of functions and measurements.



To use the XY horizontal mode

The XY horizontal mode converts the oscilloscope from a volts-versus-time display to a volts-versus-volts display using two input channels. Channel 1 is the X-axis input, channel 2 is the Y-axis input. You can use various transducers so the display could show strain versus displacement, flow versus pressure, volts versus current, or voltage versus frequency. This exercise shows a common use of the XY display mode by measuring the phase difference between two signals of the same frequency with the Lissajous method.

- 1 Connect a sine wave signal to channel 1, and a sine wave signal of the same frequency but out of phase to channel 2.
- 2 Press the **AutoScale** key, press the **Menu/Zoom** key, then press the **XY** or **Roll** softkey to select “XY”.
- 3 Center the signal on the display with the channel 1 and 2 position (◆) knobs. Use the channel 1 and 2 volts/div knobs and the channel 1 and 2 **Vernier** softkeys to expand the signal for convenient viewing.

The phase difference angle (θ) can be calculated using the following formula (assuming the amplitude is the same on both channels):

$$\sin\theta = \frac{A}{B} \text{ or } \frac{C}{D}$$

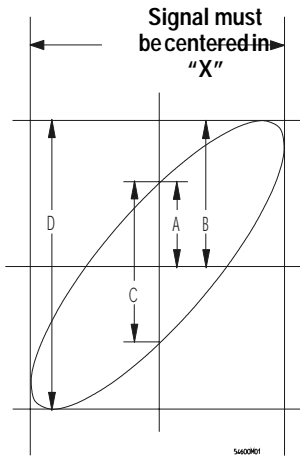

Figure 24 Example of centering a signal on the display

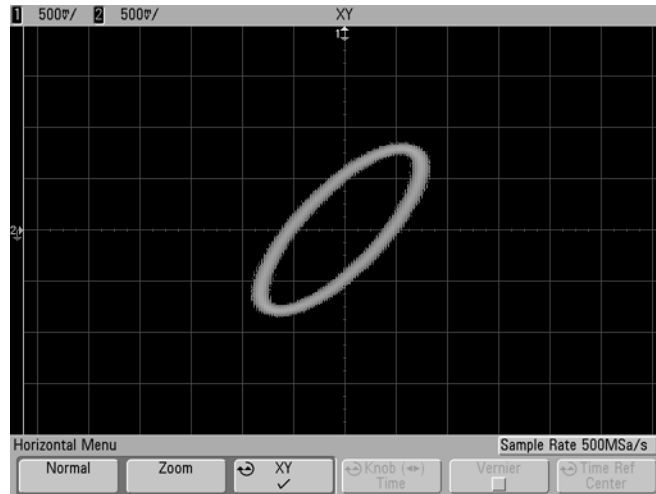

Figure 25 Signal centered on the display

- 4 Press the **Cursors** key.
- 5 Set the Y2 cursor to the top of the signal, and set Y1 to the bottom of the signal.

Note the ΔY value at the bottom of the display. In this example, we are using the Y cursors, but you could have used the X cursors instead.

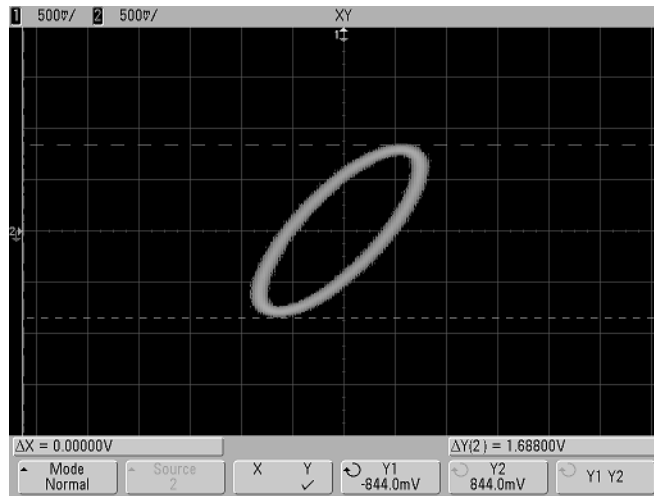

Figure 26 Cursors set on displayed signal

- 6 Move the Y1 and Y2 cursors to the intersection of the signal and the Y axis.

Again, note the ΔY value.

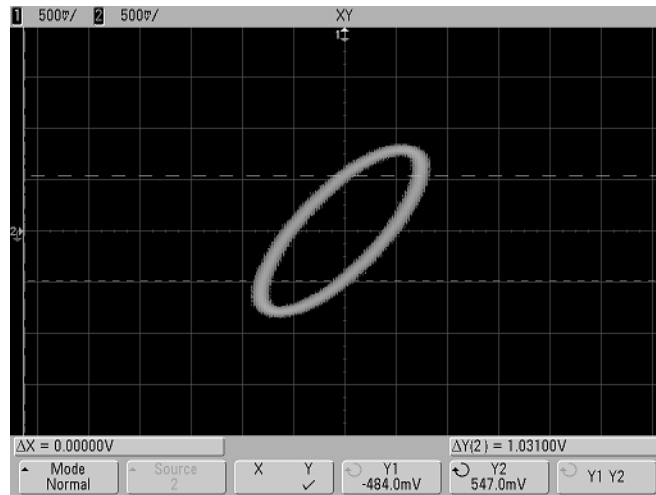

Figure 27 Cursors set to center of signal

7 Calculate the phase difference using the formula below.

$$\sin \theta = \frac{\text{second } \Delta Y}{\text{first } \Delta Y} = \frac{1.031}{1.688} ; \theta = 37.65 \text{ degrees of phase shift}$$

Z-Axis Input in XY Display Mode (Blanking)

When you select the XY display mode, the time base is turned off. Channel 1 is the X-axis input, channel 2 is the Y-axis input, and channel 4 (or the External trigger on 2-channel models) is the Z-axis input. If you only want to see portions of the Y versus X display, use the Z-axis input. Z-axis turns the trace on and off (analog oscilloscopes called this Z-axis blanking because it turned the beam on and off). When Z is low (<1.4 V), Y versus X is displayed; when Z is high (>1.4 V), the trace is turned off.

5 Making Measurements

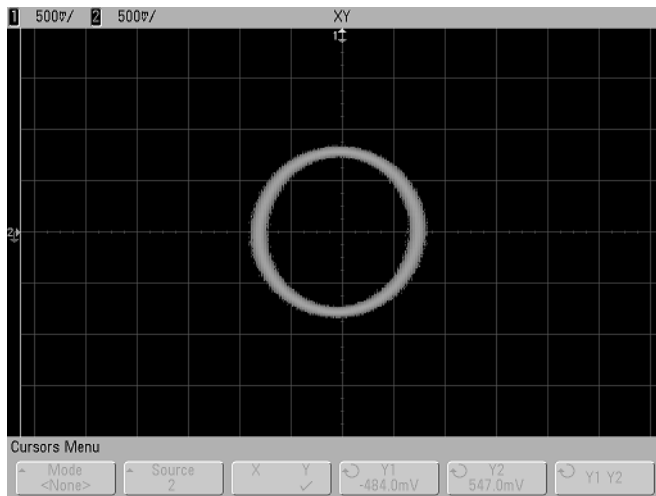

Figure 28 Signals are 90 out of phase

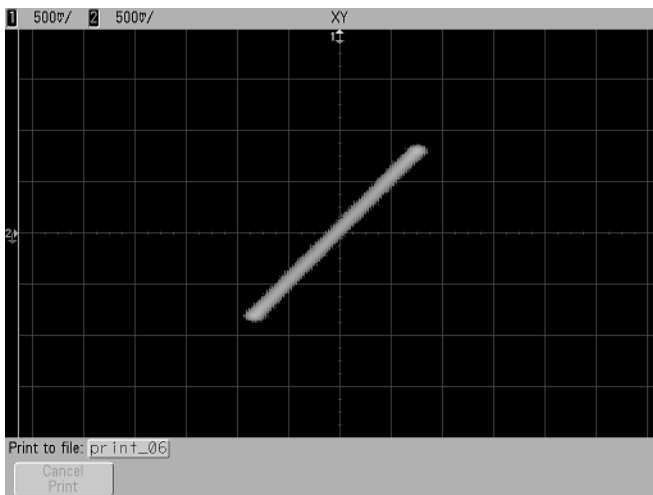

Figure 29 Signals are in phase

Math Functions

Math functions can be performed on analog channels. The resulting math waveform is displayed in light purple.

You can use a math function on a channel even if you choose not to display the channel on-screen.

You can:

- Perform an arithmetic operation (add, subtract, or multiply) on channels 1 and 2 *or* on channels 3 and 4.
- Perform a function (differentiate, integrate, FFT, or square root) on the signal acquired on an analog channel.
- Perform a function on the result of an arithmetic operation.

To use waveform math

- 1 Press the Math key on the front panel to display the Waveform Math Menu.

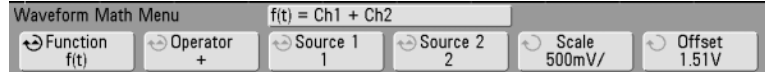

- 2 If **f(t)** is not already shown on the **Function** softkey, press the **Function** softkey and select **f(t)**: **Displayed**.
- 3 Use the **Operator** softkey to select an operator.
- 4 Use the **Source 1** softkey to select the analog channel on which to perform math. You can rotate the Entry knob or repetitively press the **Source 1** key to make your selection. If you choose a function (differentiate, integrate, FFT, or square root) the result is displayed.
- 5 If you select an arithmetic operator, use the **Source 2** softkey to select the second source for the arithmetic operation. The result is displayed.
- 6 Use the **Scale** and **Offset** softkeys to re-size and re-position the math waveform.

To perform a math function upon an arithmetic operation

To perform a function (differentiate, integrate, FFT, or square root) on an arithmetic operation (add, subtract, or multiply):

- 1 Press the **Function** softkey and select **g(t): Internal**.
- 2 Use the **Operator, Source 1, and Source 2** softkeys to set up an arithmetic operation.
- 3 Press the **Function** softkey and select **f(t): Displayed**.
- 4 Use the **Operator** softkey to select a function (differential, integral, FFT, or square root).
- 5 Press the **Source 1** softkey and select **g(t)** as the source. Note that **g(t)** is only available when you select a function in the previous step.

Math Operating Hints

If the analog channel or math function is clipped (not fully displayed on screen) the resulting displayed math function will also be clipped.

Once the function is displayed, the analog channel(s) may be turned off for better viewing of the math waveform.

The vertical scaling and offset of each math function can be adjusted for ease of viewing and measurement considerations.

The math function waveform can be measured using Cursors and/or Quick Meas.

Math scale and offset

Any math function may be manually scaled by pressing the **Scale** or **Offset** softkeys and adjusting the value.

Math Scale and Offset are Set Automatically

Any time the currently displayed math function definition is changed, the function is automatically scaled for optimum vertical scale and offset. If you manually set scale and offset for a function, select a new function, then select the original function, the original function will be automatically rescaled.

- 1 In the Waveform Math Menu, press the **Scale** or **Offset** softkeys to set your own scale factors (units/division) or offset (units)

for the selected math function. The **Function** softkey must be set to **f(t): Displayed** in order to set scale and offset.

- 2 Press the **Scale** or **Offset** softkey, then turn the Entry knob to rescale or change the offset value for your math function.

Units

Units for each input channel can be set to Volts or Amps using the **Units** softkey in the channel's **Probe** menu. Scale and offset units are:

Math function	Units
add or subtract	V or A
multiply	V^2 , A^2 , or W (Volt-Amp)
d/dt	V/s or A/s (V/second or A/second)
$\int dt$	Vs or As (V-seconds or A-seconds)
FFT	dB* (decibels)
$\sqrt{\text{ (square root)}}$	$V^{1/2}$, $A^{1/2}$, or $W^{1/2}$ (Volt-Amp)

* When the FFT source is channel 1, 2, 3 or 4, FFT units will be displayed in dBV when channel units is set to Volts and channel impedance is set to 1 M Ω . FFT units will be displayed in dBm when channel units is set to Volts and channel impedance is set to 50 Ω . FFT units will be displayed as dB for all other FFT sources or when a source channel's units has been set to Amps.

A scale unit of **U** (undefined) will be displayed for math functions when two source channels are used and they are set to dissimilar units and the combination of units can not be resolved.

Multiply

When you select the multiply math function, the voltage values of the channel chosen in **Source 1** are multiplied point by point by the voltage values of the channel chosen in **Source 2**, and the result is displayed. Multiply is useful for seeing power relationships when one of the channels is proportional to the current.

Example: Multiply channel 1 by channel 2

- **Scale** – lets you set your own vertical scale factors for multiply expressed as V^2/div (Volts-squared/division), A^2/div (Amps-squared/division), or W/div (Watts/division or Volt-Amps/division). Units are set in the channel **Probe** menu. Press the **Scale** softkey, then turn the Entry knob to rescale the math waveform.
- **Offset** – lets you set your own offset for the multiply math function. The offset value is in V^2 (Volts-squared), A^2 (Amps-squared), or W (Watts) and is represented by the center horizontal grid line of the display. Press the **Offset** softkey, then turn the Entry knob to change the offset for the math waveform.

The figure below shows an example of multiply.

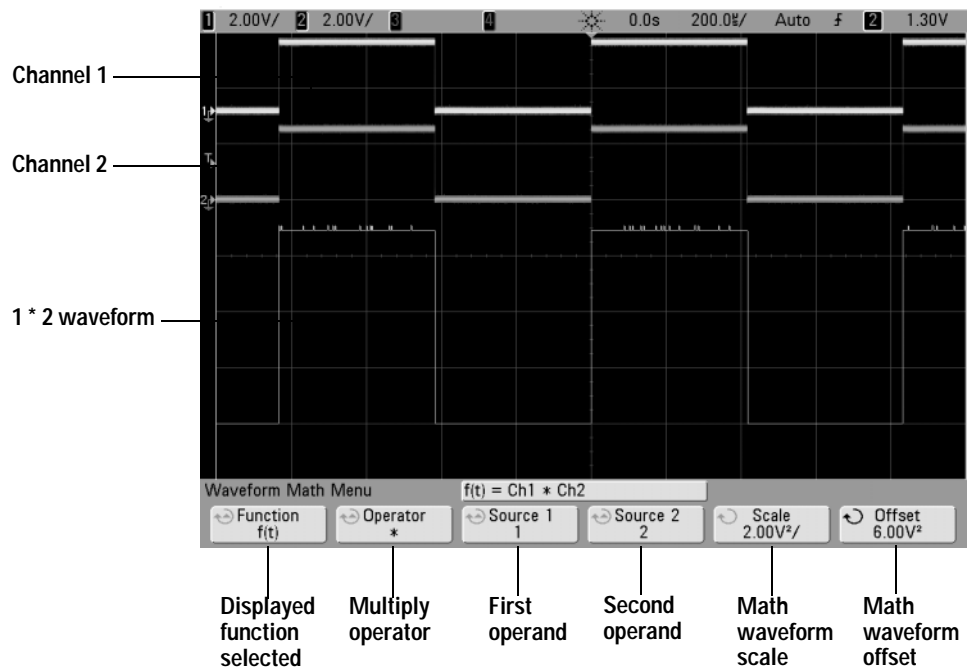

Figure 30 Multiply

Add or Subtract

When you select add or subtract, the **Source 1** and **Source 2** channel voltage values are added or subtracted point by point, and the result is displayed.

You can use subtract to make a differential measurement or to compare two waveforms. If your waveforms' DC offsets are larger than the dynamic range of the oscilloscope's input channels you will need to use a differential probe instead.

Example: Subtract channel 2 from channel 1

- **Scale** – lets you set your own vertical scale factors for subtract, expressed as V/div (Volts/division) or A/div (Amps/division). Press the **Scale** softkey, then turn the Entry knob to rescale. Units are set in the channel **Probe** menu.
- **Offset** – lets you set your own offset for the math function. The offset value is in Volts or Amps and is represented by the center horizontal grid line of the display. Press the **Offset** softkey, then turn the Entry knob to change the offset of the math waveform.

A scale unit of **U** (undefined) will be displayed for scale and offset if the two source channels are set to dissimilar units. Units are set using the channel's **Probe Units** softkey.

The figure below shows an example of subtract.

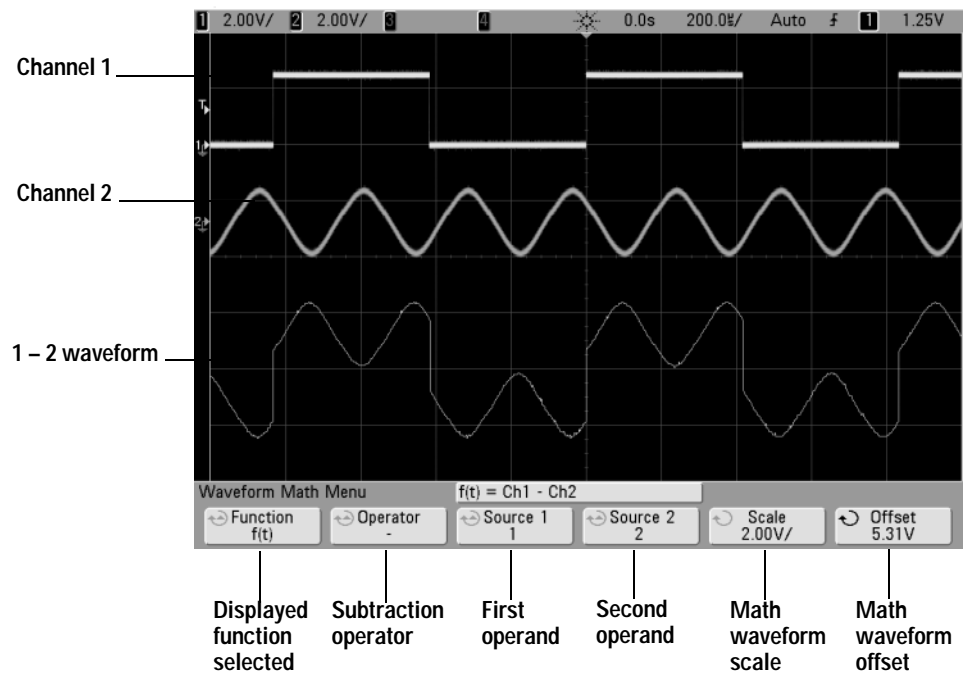

Figure 31 Subtract

Differentiate

d/dt (differentiate) calculates the discrete time derivative of the selected source. You can use differentiate to measure the instantaneous slope of a waveform. For example, the slew rate of an operational amplifier may be measured using the differentiate function.

Because differentiation is very sensitive to noise, it is helpful to set acquisition mode to **Averaging** in the **Acquire** menu.

d/dt plots the derivative of the selected source using the “average slope estimate at 4 points” formula. The equation is:

$$d_i = \frac{y_{i+4} + 2y_{i+2} - 2y_{i-2} - y_{i-4}}{8\Delta t}$$

Where

d = differential waveform

y = channel 1, 2, 3, or 4, or g(t) (internal arithmetic operation) data points

i = data point index

Δt = point-to-point time difference

In horizontal sweep **Zoom** mode, the d/dt function does not display in the zoomed portion of the display.

- 1 Press the **Math** key, press the **Function** softkey and select **f(t)**, press the **Operator** softkey and select **d/dt**. Press the **Source**, **Scale**, or **Offset** softkeys if you want to change the source, scaling, or offset for the differentiate function.
 - **Source** – selects the source for d/dt. (See page 220 for information about using **g(t)** as the source.)
 - **Scale** – lets you set your own vertical scale factors for d/dt expressed in units/second/division, where units can be V (Volts), A (Amps), or W (Watts). Units are set in the channel **Probe** menu. Press the **Scale** softkey, then turn the Entry knob to rescale d/dt.

- **Offset** —lets you set your own offset for the dV/dt math function. The offset value is in units/second where units can be V (Volts), A (Amps), or W (Watts) and is represented by the center horizontal grid line of the display. Press the **Offset** softkey, then turn the Entry knob to change the offset for d/dt .

A scale unit of **U** (undefined) will be displayed for scale and offset if the two source channels are set to dissimilar units. Units are set using the channel's **Probe Units** softkey.

The figure below shows an example of differentiate.

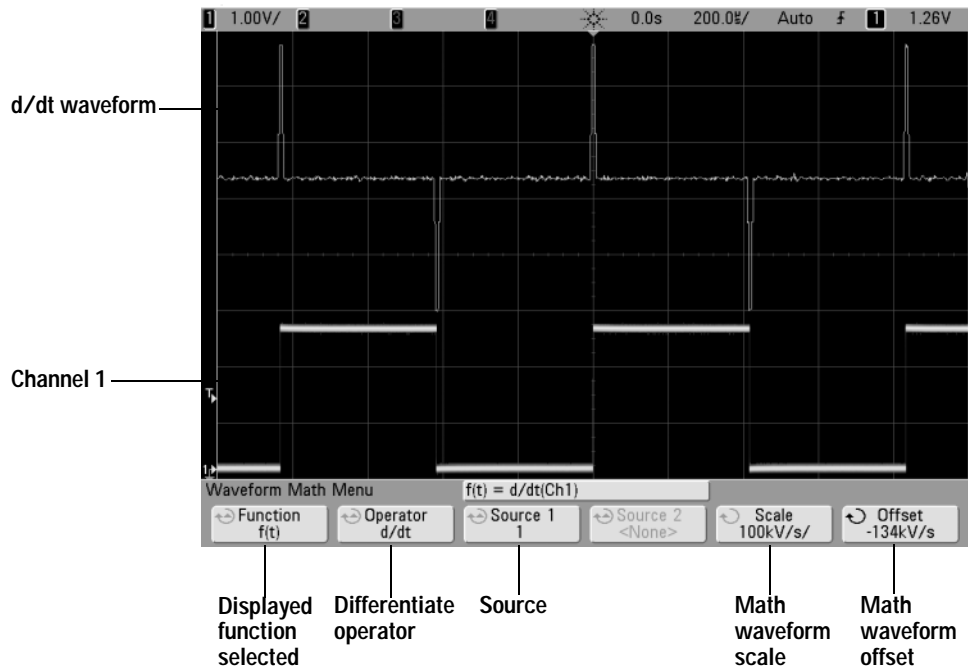

Figure 32 Differentiate

Integrate

$\int dt$ (integrate) calculates the integral of the selected source. You can use integrate to calculate the energy of a pulse in volt-seconds or measure the area under a waveform.

$\int dt$ plots the integral of the source using the “Trapezoidal Rule”. The equation is:

$$I_n = c_o + \Delta t \sum_{i=0}^n y_i$$

Where

I = integrated waveform

Δt = point-to-point time difference

y = channel 1, 2, 3, or 4, or g(t) (internal arithmetic operation)

c_o = arbitrary constant

i = data point index

In horizontal sweep **Zoom** mode, the $\int dt$ function does not display in the Zoom portion of the display.

- 1 Press the **Math** key, press the **Function** softkey and select **f(t)**, press the **Operator** softkey and select $\int dt$. Press the **Source**, **Scale**, or **Offset** softkeys if you want to change the source, scaling, or offset for the differentiate function.
 - **Source** – selects the source for $\int dt$. (See page 220 for information about using **g(t)** as the source.)
 - **Scale** – lets you set your own vertical scale factors for $\int dt$ expressed in unit-seconds/division, where units can be V (Volts), A (Amps), or W (Watts). Units are set in the channel **Probe** menu. Press the **Scale** softkey, then turn the Entry knob to rescale $\int dt$.
 - **Offset** – lets you set your own offset for the $\int Vdt$ math function. The offset value is in unit-seconds where units can be V (Volts), A (Amps), or W (Watts) and is represented by the center horizontal grid line of the display. Press the **Offset** softkey, then turn the Entry knob to change the offset for $\int dt$. The integrate calculation is relative to the source signal’s offset. The following examples illustrate the effects of signal offset.

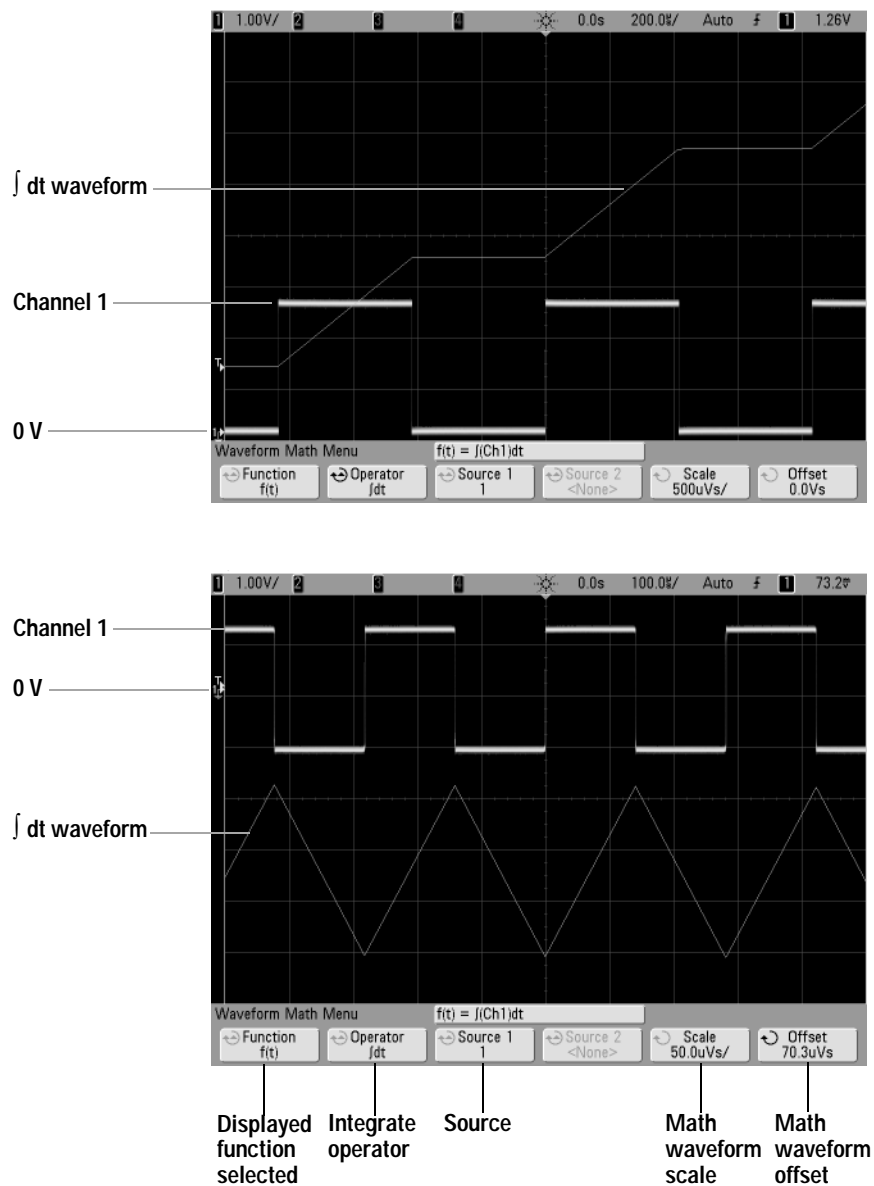

Figure 33 Integrate and Signal Offset

FFT Measurement

FFT is used to compute the fast Fourier transform using analog input channels or an arithmetic operation $g(t)$. FFT takes the digitized time record of the specified source and transforms it to the frequency domain. When the FFT function is selected, the FFT spectrum is plotted on the oscilloscope display as magnitude in dBV versus frequency. The readout for the horizontal axis changes from time to frequency (Hertz) and the vertical readout changes from volts to dB.

Use the FFT function to find crosstalk problems, to find distortion problems in analog waveforms caused by amplifier non-linearity, or for adjusting analog filters.

FFT Units

0 dBV is the amplitude of a 1 Vrms sinusoid. When the FFT source is channel 1 or channel 2 (or channel 3 or 4 on 4-channel models), FFT units will be displayed in dBV when channel units is set to Volts and channel impedance is set to 1 M Ω .

FFT units will be displayed in dBm when channel units is set to Volts and channel impedance is set to 50 Ω .

FFT units will be displayed as dB for all other FFT sources or when a source channel's units has been set to Amps.

DC Value

The FFT computation produces a DC value that is incorrect. It does not take the offset at center screen into account. The DC value is not corrected in order to accurately represent frequency components near DC.

Aliasing

When using FFTs, it is important to be aware of frequency aliasing. This requires that the operator have some knowledge as to what the frequency domain should contain, and also consider the sampling rate, frequency span, and oscilloscope

vertical bandwidth when making FFT measurements. The FFT sample rate is displayed directly above the softkeys when the FFT menu is displayed.

Aliasing happens when there are frequency components in the signal higher than half the sample rate. Since the FFT spectrum is limited by this frequency, any higher components are displayed at a lower (aliased) frequency.

The following figure illustrates aliasing. This is the spectrum of a 990 Hz square wave, which has many harmonics. The FFT sample rate is set to 100 kSa/s, and the oscilloscope displays the spectrum. The displayed waveform shows the components of the input signal above the Nyquist frequency to be mirrored (aliased) on the display and reflected off the right edge.

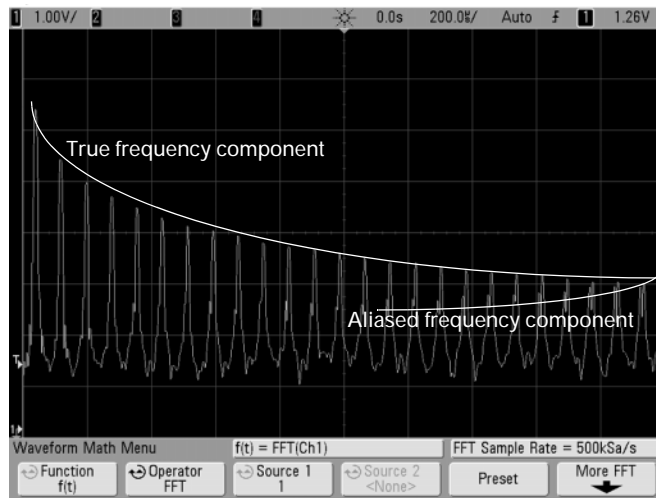

Figure 34 Aliasing

Since the frequency span goes from ≈ 0 to the Nyquist frequency, the best way to prevent aliasing is to make sure that the frequency span is greater than the frequencies of significant energy present in the input signal.

Spectral Leakage

The FFT operation assumes that the time record repeats. Unless there is an integral number of cycles of the sampled waveform in the record, a discontinuity is created at the end of the record. This is referred to as leakage. In order to minimize spectral leakage, windows that approach zero smoothly at the beginning and end of the signal are employed as filters to the FFT. The FFT menu provides four windows: Hanning, flattop, rectangular, and Blackman-Harris. For more information on leakage, see Agilent Application Note 243, “The Fundamentals of Signal Analysis” at <http://cp.literature.agilent.com/litweb/pdf/5952-8898E.pdf>.

FFT Operation

- 1 Press the **Math** key, press the **Function** softkey and select **f(t)**, press the **Operator** softkey and select **FFT**.

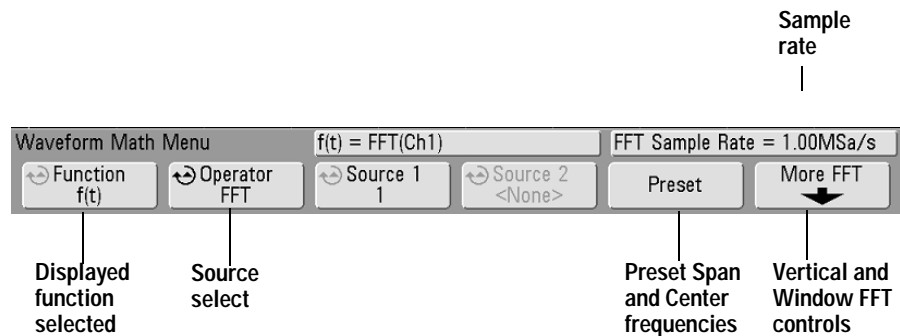

- **Source 1** – selects the source for the FFT. (See page 220 for information about using **g(t)** as the source.)
 - **Preset** – sets the frequency Span and Center to values that will cause the entire available spectrum to be displayed. The maximum available frequency is half the effective FFT sample rate, which is a function of the time per division setting. The current FFT sample rate is displayed above the softkeys.
 - **More FFT** – displays the More FFT Settings menu.
- 2 Press the More FFT softkey to display additional FFT settings.

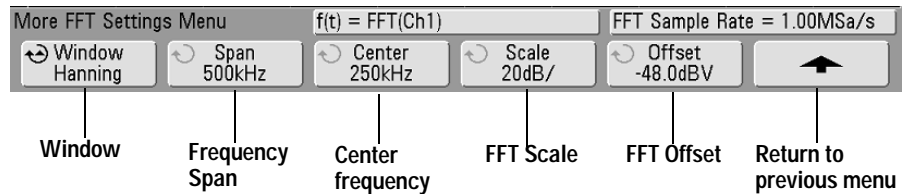

- **Window** – selects a window to apply to your FFT input signal:
 - **Hanning** – window for making accurate frequency measurements or for resolving two frequencies that are close together.
 - **Flat Top** – window for making accurate amplitude measurements of frequency peaks.
 - **Rectangular** – good frequency resolution and amplitude accuracy, but use only where there will be no leakage effects. Use on self-windowing waveforms such as pseudo-random noise, impulses, sine bursts, and decaying sinusoids.
 - **Blackman Harris** – window reduces time resolution compared to a rectangular window, but improves the capacity to detect smaller impulses due to lower secondary lobes.
- **Span** – sets the overall width of the FFT spectrum that you see on the display (left to right). Divide span by 10 to calculate the number of Hertz per division. It is possible to set Span above the maximum available frequency, in which case the displayed spectrum will not take up the whole screen. Press the **Span** softkey, then turn the Entry knob to set the desired frequency span of the display.
- **Center** – sets the FFT spectrum frequency represented at the center vertical grid line of the display. It is possible to set the Center to values below half the span or above the maximum available frequency, in which case the displayed spectrum will not take up the whole screen. Press the **Center** softkey, then turn the Entry knob to set the desired center frequency of the display.

- **Scale** – lets you set your own vertical scale factors for FFT expressed in dB/div (decibels/division). Press the **Scale** softkey, then turn the Entry knob to rescale your math function.
- **Offset** – lets you set your own offset for the FFT. The offset value is in dB and is represented by the center horizontal grid line of the display. Press the **Offset** softkey, then turn the Entry knob to change the offset of your math function.

Scale and offset considerations

If you do not manually change the FFT scale or offset settings, when you turn the horizontal sweep speed knob, the span and center frequency settings will automatically change to allow optimum viewing of the full spectrum. If you do manually set scale or offset, turning the sweep speed knob will not change the span or center frequency settings, allowing you see better detail around a specific frequency. Pressing the FFT **Preset** softkey will automatically rescale the waveform and span and center will again automatically track the horizontal sweep speed setting.

- 3 To make cursors measurements, press the **Cursors** key and set the **Source** softkey to **Math: f(t)**.

Use the X1 and X2 cursors to measure frequency values and difference between two frequency values (ΔX). Use the Y1 and Y2 cursors to measure amplitude in dB and difference in amplitude (ΔY).

- 4 To make other measurements, press the **Quick Meas** key and set the **Source** softkey to **Math: f(t)**.

You can make peak-to-peak, maximum, minimum, and average dB measurements on the FFT waveform. You can also find the frequency value at the first occurrence of the waveform maximum by using the X at Max Y measurement.

The following FFT spectrum was obtained by connecting the front panel Probe Comp signal (approximately 1.2 kHz square wave) to channel 1. Set sweep speed to 5 ms/div, vertical sensitivity to 500 mV/div, Units/div to 10 dBV, Offset to -34.0 dBV, Center frequency to 5.00 kHz, frequency Span to 10.0 kHz, and window to Hanning.

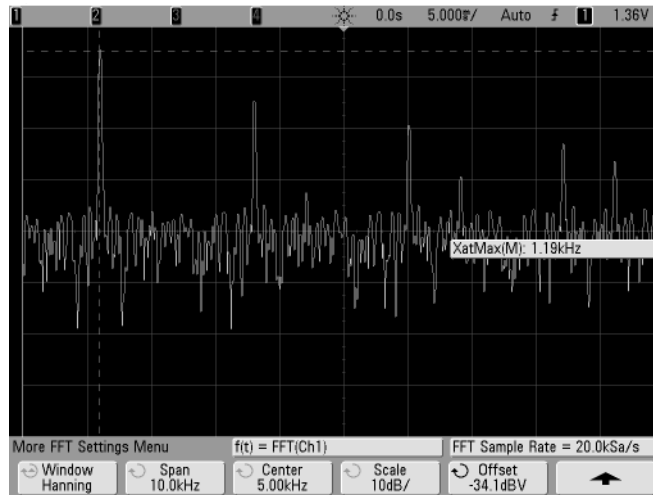

Figure 35 FFT measurements

FFT Measurement Hints

The number of points acquired for the FFT record is 1000 and when frequency span is at maximum, all points are displayed. Once the FFT spectrum is displayed, the frequency span and center frequency controls are used much like the controls of a spectrum analyzer to examine the frequency of interest in greater detail. Place the desired part of the waveform at the center of the screen and decrease frequency span to increase the display resolution. As frequency span is decreased, the number of points shown is reduced, and the display is magnified.

While the FFT spectrum is displayed, use the **Math** and **Cursors** keys to switch between measurement functions and frequency domain controls in FFT menu.

Decreasing the effective sampling rate by selecting a slower sweep speed will increase the low frequency resolution of the FFT display and also increase the chance that an alias will be displayed. The resolution of the FFT is the effective sample rate divided by the number of points in the FFT. The actual resolution of the display will not be this fine as the shape of the window will be the actual limiting factor in the FFT's ability to

resolve two closely spaced frequencies. A good way to test the ability of the FFT to resolve two closely spaced frequencies is to examine the sidebands of an amplitude modulated sine wave.

For the best vertical accuracy on peak measurements:

- Make sure the probe attenuation is set correctly. The probe attenuation is set from the Channel menu if the operand is a channel.
- Set the source sensitivity so that the input signal is near full screen, but not clipped.
- Use the Flat Top window.
- Set the FFT sensitivity to a sensitive range, such as 2 dB/division.

For best frequency accuracy on peaks:

- Use the Hanning window.
- Use Cursors to place an X cursor on the frequency of interest.
- Adjust frequency span for better cursor placement.
- Return to the Cursors menu to fine tune the X cursor.

For more information on the use of FFTs please refer to Agilent Application Note 243, "The Fundamentals of Signal Analysis" at <http://cp.literature.agilent.com/litweb/pdf/5952-8898E.pdf>. Additional information can be obtained from Chapter 4 of the book "Spectrum and Network Measurements" by Robert A. Witte.

Square Root

Square root ($\sqrt{\quad}$) calculates the square root of the selected source.

In horizontal Zoom mode, the square root function does not display in the Zoom portion of the display.

1 Press the **Math** key, press the **Function** softkey and select **f(t)**, press the **Operator** softkey and select $\sqrt{\quad}$ (square root). Press the **Source 1**, **Scale**, or **Offset** softkeys if you want to change the source, scaling, or offset for the square root function.

- **Source 1** – selects the source for $\sqrt{\quad}$ (square root). (See page 220 for information about using **g(t)** as the source.)
- **Scale** – lets you set your own vertical scale factors for $\sqrt{\quad}$ (square root) expressed as $V^{1/2}/\text{div}$ (Volts-square-root/division), $A^{1/2}/\text{div}$ (Amps-square-root/division), or $W^{1/2}/\text{div}$ (Watts-square-root/division or Volt-Amps-square-root/division). Units are set in the channel **Probe** menu. Press the **Scale** softkey, then turn the Entry knob to rescale $\sqrt{\quad}$ (square root).
- **Offset** – lets you set your own offset for the multiply math function. The offset value is in $V^{1/2}$ (Volts-square-root), $A^{1/2}$ (Amps-square-root), or $W^{1/2}$ (Watts-square-root) and is represented by the center horizontal grid line of the display. Press the **Offset** softkey, then turn the Entry knob to change the offset for $\sqrt{\quad}$ (square root).

A scale unit of **U** (undefined) will be displayed for scale and offset if the two source channels are set to dissimilar units. Units are set using the channel's **Probe Units** softkey.

The figure below shows an example of $\sqrt{\quad}$ (square root).

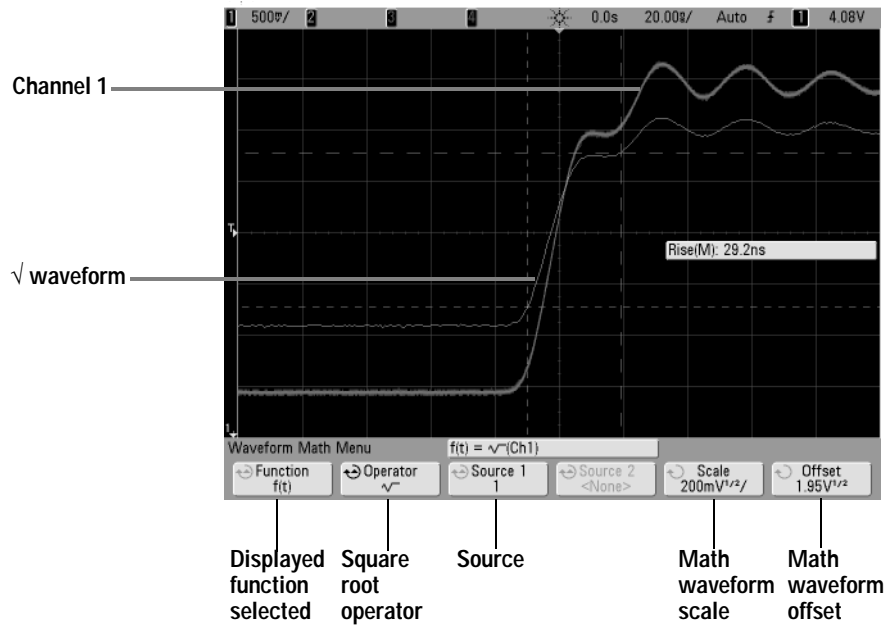

Figure 36 Square Root

Cursor Measurements

You can measure waveform data using cursors. Cursors are horizontal and vertical markers that indicate X-axis values (usually time) and Y-axis values (usually voltage) on a selected waveform source. The position of the cursors can be moved by turning the Entry knob. When you press the **Cursors** key, it will illuminate and the cursors will turn on. To turn cursors off, press this key again until it is not illuminated, or press the **Quick Meas** key.

Cursors are not always limited to the visible display. If you set a cursor, then pan and zoom the waveform until the cursor is off screen, its value will not be changed, and if you pan the waveform back again it will have the cursor in the original place.

To make cursor measurements

A brief description of how to make cursor measurements is given on page 102.

The following steps guide you through using the front-panel **Cursors** key. You can use the cursors to make custom voltage or time measurements on the signal.

- 1 Connect a signal to the oscilloscope and obtain a stable display.
- 2 Press the **Cursors** key (the key will illuminate, indicating that cursors are “on”). Use the softkeys in the Cursors menu to set up your measurement.
 - **Mode**
 - **Manual** – X, $1/\Delta X$, and ΔY values are displayed. Use the Entry knob and softkeys to change cursor positions.
 - **Track Waveform** – (This feature is enabled at time of purchase with License MST, or with N5466A post-purchase.) Y1 cursor tracks the waveform assigned to Source 1 as X1 is moved, and Y2 cursor tracks the waveform assigned to Source 2 as X2 is moved.

- **Binary** – Logic levels of displayed waveforms at the current X1 and X2 cursor positions are displayed above the softkeys in binary. The display is color coded to match the color of the related channel's waveform.
- **Hex** – Logic levels of displayed waveforms at the current X1 and X2 cursor positions are displayed above the softkeys in hexadecimal.

In **Hex** and **Binary** modes, a level can be displayed as 1 (higher than trigger level), 0 (lower than trigger level), indeterminate state (), or X (don't care). In Binary mode, X is displayed if the channel is turned off. In Hex mode, the channel is interpreted as a low if turned off.

- **Source** – selects a channel or math function for the cursor measurements.
- **X Y** – Select either the X cursors or the Y cursors for adjustment with the Entry knob.
- **X1, X2** – adjust horizontally and normally measure time.
- **Y1, Y2** – adjust vertically and normally measure voltage.
- **X1 X2** or **Y1 Y2** – move the cursors together when turning the Entry knob.

NOTE

If you intend to make cursor measurements on a trace that you recall from memory, be sure to recall both setup and trace. See “To recall waveform trace and/or oscilloscope setup” on page 368.

- **Manual** – ΔX , $1/\Delta X$, and ΔY values are displayed. ΔX is the difference between the X1 and X2 cursors and ΔY is the difference between the Y1 and Y2 cursors.

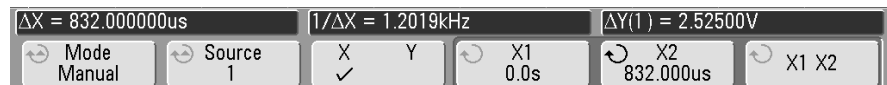

- **Track Waveform** – As you move a marker horizontally, the vertical amplitude of the waveform is tracked and measured. At the bottom of the display, the time and voltage positions are shown for the markers. The vertical (Y) and horizontal (X) differences between the markers are shown as ΔX and ΔY values.

- **Binary** – Logic levels of displayed waveforms at the current X1 and X2 cursor positions are displayed above the softkeys in binary. The display is color coded to match the color of the related channel's waveform.

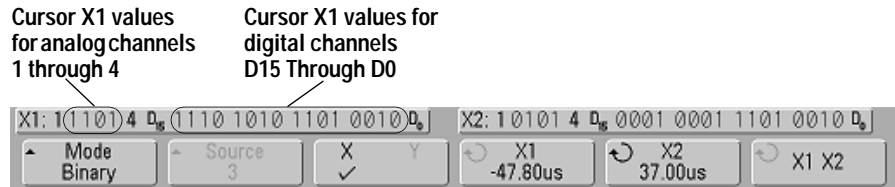

- **Hex** – Logic levels of displayed waveforms at the current X1 and X2 cursor positions are displayed above the softkeys in hexadecimal.



In hexadecimal and binary mode, a level can display as 1 (higher than trigger level), 0 (lower than trigger level), indeterminate state (↕), or X (don't care). In binary mode, X is displayed if the channel is turned off. In hex mode, the channel is interpreted as a 0 if turned off.

- 3 Press the **Source** softkey to select the analog channel or math source on which the Y cursors will indicate measurements.

The source in **Normal** cursor mode can be any analog channel or math source. If you select binary or hexadecimal mode, the **Source** softkey is disabled since you are displaying binary or hexadecimal levels for all channels.

4 Select the X and Y softkeys to make a measurement.

- **X Y** – Press this softkey to select either X cursors or Y cursors for adjustment. The cursor currently assigned to the Entry knob displays brighter than the other cursors.

X cursors are vertical dashed lines that adjust horizontally and normally indicate time relative to the trigger point. When used with the FFT math function as a source, the X cursors indicate frequency.

Y cursors are horizontal dashed lines that adjust vertically and normally indicate Volts or Amps, dependent on the channel **Probe Units** setting. When math functions are used as a source, the measurement units correspond to that math function.

- **X1 and X2** – The X1 cursor (short-dashed vertical line) and X2 cursor (long-dashed-vertical line) adjust horizontally and indicate time relative to the trigger point for all sources except math FFT (frequency is indicated). In XY horizontal mode, the X cursors display channel 1 values (Volts or Amps). The cursor values for the selected waveform source are displayed within the X1 and X2 softkeys.

The difference between X1 and X2 (ΔX) and $1/\Delta X$ are displayed on the dedicated line above the softkeys or in the display area when some menus are selected.

Turn the Entry knob to adjust the X1 or X2 cursor when its softkey is selected.

- **Y1 and Y2** – The Y1 cursor (short-dashed horizontal line) and Y2 cursor (long-dashed horizontal line) adjust vertically and indicate values relative to the waveform's ground point, except math FFT where the values are relative to 0 dB. In XY horizontal mode, the Y cursors display channel 2 values (Volts or Amps). The cursor values for the selected waveform source are displayed within the Y1 and Y2 softkeys.

The difference between Y1 and Y2 (ΔY) is displayed on the dedicated line above the softkeys or in the display area when some menus are selected.

Turn the Entry knob to adjust the Y1 or Y2 cursor when its softkey is selected.

- **X1 X2** – Press this softkey to adjust the X1 and X2 cursors together by turning the Entry knob. The ΔX value will remain the same since the cursors adjust together.

You can adjust the X cursors together to check for pulse width variations in a pulse train.

- **Y1 Y2** – Press this softkey to adjust the Y1 and Y2 cursors together by turning the Entry knob. The ΔY value will remain the same since the cursors adjust together.

NOTE

After adjusting the X1, X2, X1 X2, Y1, Y2, or Y1 Y2 controls, you can press the Entry knob to adjust the next control.

Cursor Examples

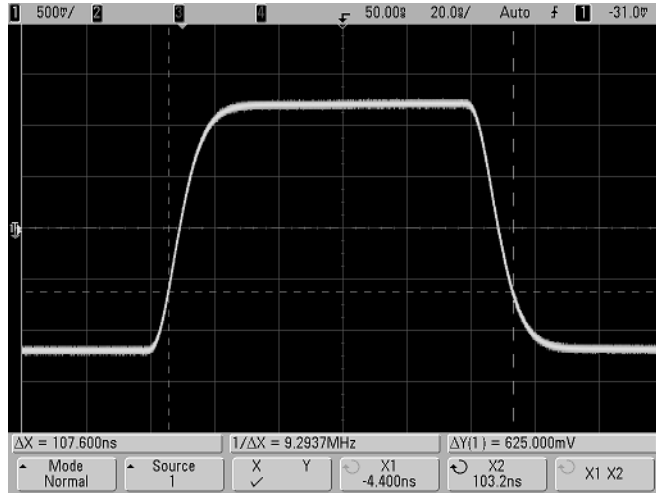

Figure 37 Cursors measure pulse widths other than middle threshold points

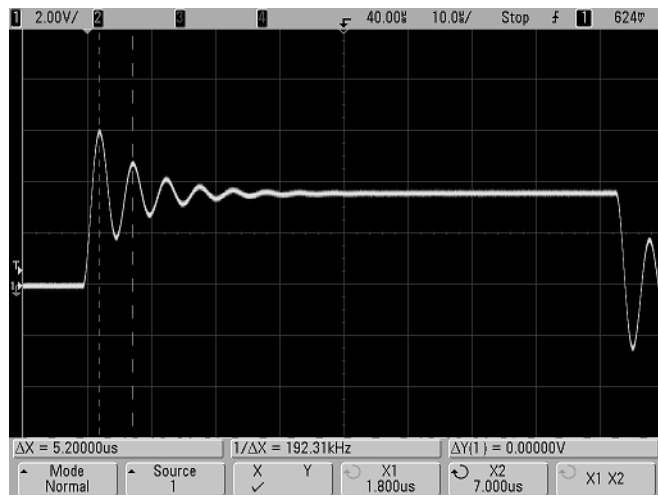

Figure 38 Cursors measure frequency of pulse ringing

Expand the display with zoom sweep, then characterize the event of interest with the cursors.

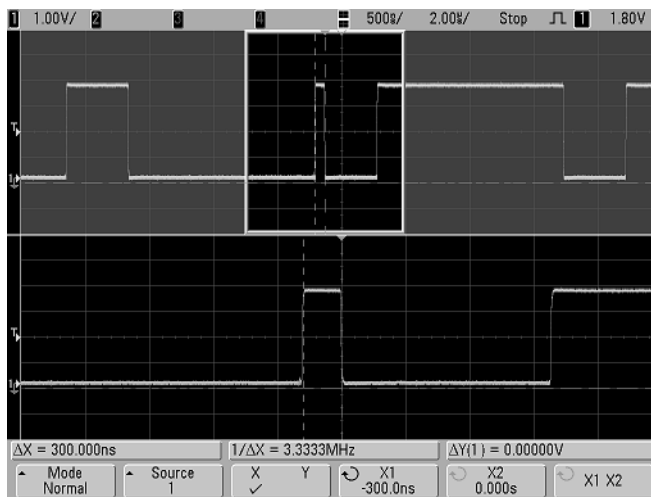

Figure 39 Cursors track zoom sweep

Put the **X1** cursor on one side of a pulse and the **X2** cursor on the other side of the pulse.

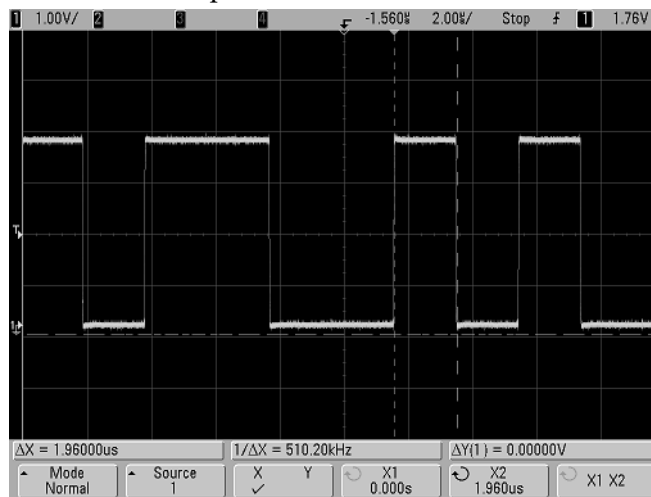

Figure 40 Measuring pulse width with cursors

Press the **X1 X2** softkey and move the cursors together to check for pulse width variations in a pulse train.

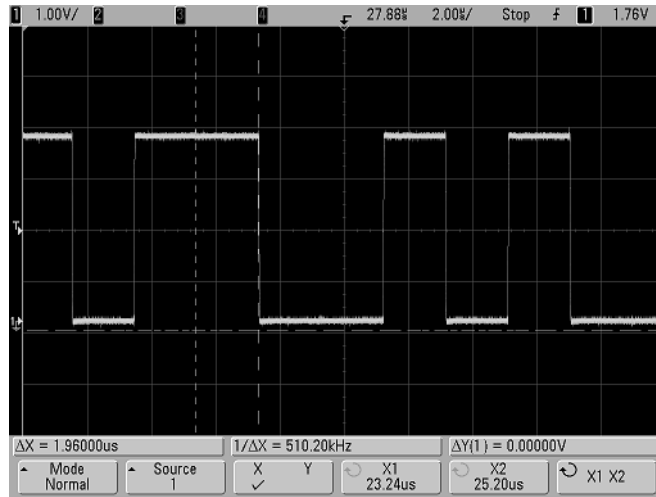

Figure 41 Moving the cursors together to check pulse width variations

Automatic Measurements

The following automatic measurements can be made in the Quick Meas menu.

Time Measurements

- Counter
- Duty Cycle
- Frequency
- Period
- Rise Time*
- Fall Time*
- + Width
- – Width
- X at Max Y*
- X at Min Y*

Phase and Delay

- Phase*
- Delay*

Voltage Measurements

- Average*
- Amplitude*
- Base*
- Maximum*
- Minimum*
- Peak-to-Peak*
- Ratio*
- RMS*
- Std Deviation*
- Top*

Preshoot and Overshoot

- Preshoot*
- Overshoot*

* Measurement on analog channels only.

To make an automatic measurement

A brief description of how to make automatic measurements is given on page 103.

Quick Meas makes automatic measurements on any channel source or any running math function. The results of the last four measurements selected are displayed on the dedicated line above the softkeys, or in the display area when some menus are selected. Quick Meas also makes measurements on stopped waveforms when you are panning and zooming.

Cursors are turned on to show the portion of the waveform being measured for the most recently selected measurement (right-most on the measurement line).

- 1 Press the **Quick Meas** key to display the automatic measurement menu.

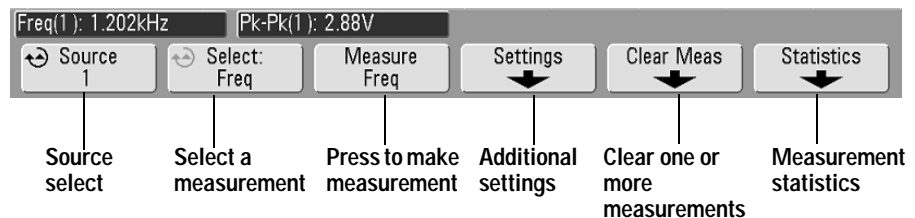

- 2 Press the **Source** softkey to select the channel or running math function on which the measurement will be made.

Only channels or math functions that are displayed are available for measurements. If you choose an invalid source channel for a measurement, the measurement will default to the nearest in the list that makes the source valid.

If a portion of the waveform required for a measurement is not displayed or does not display enough resolution to make the measurement, the result will display “No Edges”, “Clipped”, “Low Signal”, “< value”, or “> value”, or a similar message to indicate that the measurement may not be reliable.

- 3 Press the **Select** softkey then rotate the Entry knob to select a measurement to be made.



- 4 The **Settings** softkey will be available to make additional measurement settings on some measurements.
- 5 Press the **Measure** softkey to make the measurement. (By default, measurement statistics are displayed. See page 249.)
- 6 To turn off **Quick Meas**, press the **Quick Meas** key again until it is not illuminated.
- 7 To stop making one or more measurements, press the **Clear Meas** softkey and choose the measurement to clear, or press **Clear All**.



- 8 After all measurements have been cleared, when **Quick Meas** is pressed again, the default measurements will be Frequency and Peak-Peak.

Measurement Statistics

This feature is enabled at time of purchase with License MST, or with N5466A “InfiniiVision Feature Upgrade” post-purchase.

Press the **Quick Meas** key to enter the Measurement menu. By default, statistics are displayed, and frequency and voltage are measured on channel 1.

Select the measurements you desire for the channels you are using (see page 246).

From the Measurement menu, press the **Statistics** softkey to enter the Statistics menu.

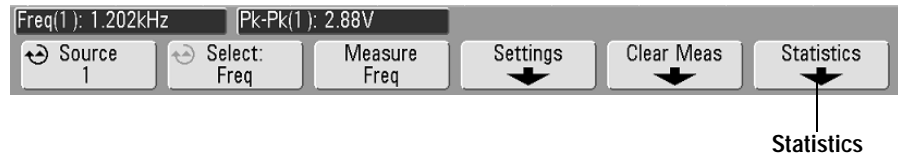

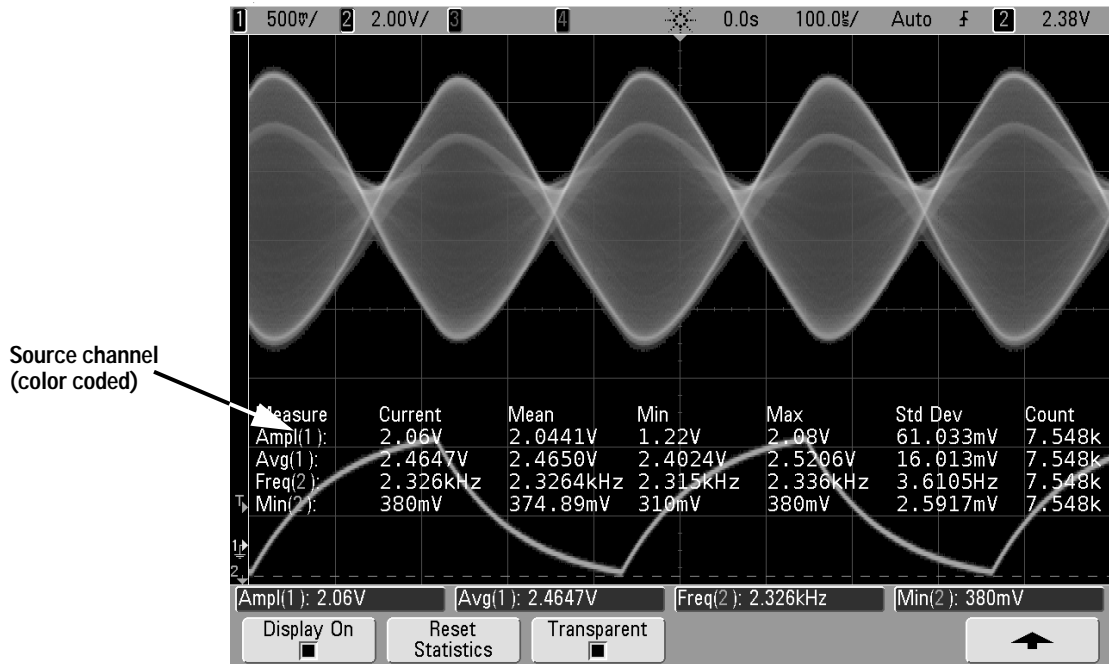

The following statistics are shown: Name of the measurement, current measured value, mean, minimum measured value, maximum measured value, standard deviation, and the number of times the measurement has been made (count).

The standard deviation shown in Statistics is calculated using the same formula used for calculating the standard deviation Quick Measurement. The formula is shown in the section titled “Std Deviation” on page 263.

The source channel of the measurement is shown in parenthesis after the measurement name. For example: “Freq(1)” indicates a frequency measurement on channel 1.

You can switch the statistics **Display On** or **Display Off**. Statistics continue to accumulate even when the statistics display is off.

When you navigate away from the Measurements menu, the statistics display will no longer be displayed, but statistical data collection will continue. Return to the Measurements menu to see the data again.

To reset the statistics measurements, press the **Reset Statistics** softkey. This resets all statistics and begins recording statistical data again.

Each time a new measurement (for example: frequency, period, or amplitude) is added the statistics are reset and accumulation of statistical data begins again.

When the **Single** key is pressed, statistics are reset and a single measurement is done (count = 1). Successive **Single** acquisitions accumulate statistical data (and the count is incremented).

Press the **Transparent** softkey to disable the Transparent mode. This shows statistics with a gray background. Press the **Transparent** softkey again to enable Transparent mode. This writes measurement values, statistics, and cursor values on the screen without a background. This controls the display of statistics in both Quick Meas and the optional Mask test feature.

The **Increment Statistics** softkey only appears when the acquisition is stopped and the optional segmented memory feature is off. Press the Single or Run/Stop key to stop the acquisition. You can use the horizontal position control (in the Horizontal control section of the front panel) to pan through the waveform. Active measurements will stay on screen, allowing you to measure various aspects of the captured waveforms. Press **Increment Statistics** to add the currently measured waveform to the collected statistical data.

The **Analyze Segments** softkey only appears when the acquisition is stopped and the optional segmented memory feature is on. After an acquisition has completed (and the oscilloscope is stopped), you can press the **Analyze Segments** softkey to accumulate measurement statistics for the acquired segments.

You can also switch on infinite persistence (in the Display menu) and press the **Analyze Segments** softkey to create an infinite persistence display.

To set measurement thresholds

Setting measurement thresholds defines the vertical levels where measurements will be taken on an analog channel or math waveform.

Changing default thresholds may change measurement results

The default lower, middle, and upper threshold values are 10%, 50%, and 90% of the value between Top and Base. Changing these threshold definitions from the default values may change the returned measurement results for Average, Delay, Duty Cycle, Fall Time, Frequency, Overshoot, Period, Phase, Preshoot, Rise Time, +Width, and -Width.

- 1 From the **Quick Meas** menu, press the **Settings** softkey, then press the **Thresholds** softkey to set analog channel measurement thresholds.
- 2 Press the **Source** softkey to select the analog channel or math waveform source for which you want to change measurement thresholds. Each analog channel and the math waveform can be assigned unique threshold values.

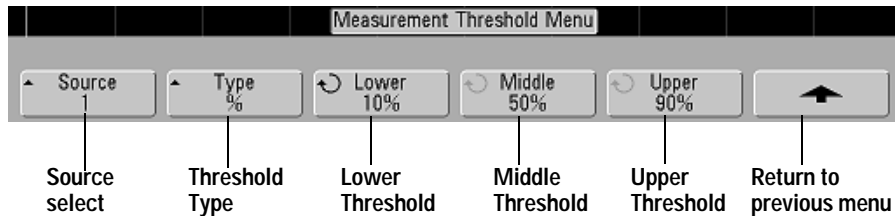

- 3 Press the **Type** softkey to set the measurement threshold to % (percentage of Top and Base value) or to **Absolute** (absolute value.)
 - Percentage thresholds can be set from 5% to 95%.
 - The units for absolute threshold for each channel is set in the channel probe menu.

- When the **Source** is set to **Math: f(t)**, the threshold **Type** can only be set to **Percent**.

Absolute threshold hints

- Absolute thresholds are dependent on channel scaling, probe attenuation, and probe units. Always set these values first before setting absolute thresholds.
- The minimum and maximum threshold values are limited to on-screen values.
- If any of the absolute threshold values are above or below the minimum or maximum waveform values, the measurement may not be valid.

- 4 Press the **Lower** softkey, then turn the Entry knob to set the lower measurement threshold value.

Increasing the lower value beyond the set middle value will automatically increase the middle value to be more than the lower value. The default lower threshold is 10% or 800 mV.

If threshold **Type** is set to **%**, the lower threshold value can be set from 5% to 93%.

- 5 Press the **Middle** softkey, then turn the Entry knob to set the middle measurement threshold value.

The middle value is bounded by the values set for lower and upper thresholds. The default middle threshold is 50% or 1.20 V.

- If threshold **Type** is set to **%**, the middle threshold value can be set from 6% to 94%.

- 6 Press the **Upper** softkey, then turn the Entry knob to set the upper measurement threshold value.

Decreasing the upper value below the set middle value will automatically decrease the middle value to be less than the upper value. The default upper threshold is 90% or 1.50 V.

- If threshold **Type** is set to **%**, the upper threshold value can be set from 7% to 95%.

Measurement Definitions

Time Measurements

FFT measurements

When you make an **X at Max Y** or **X at Min Y** measurement on a math FFT function, the resultant units will be in Hertz. No other time related automatic measurement can be made on the FFT math function. Use the cursors to make other measurements on FFT.

The default lower, middle, and upper measurement thresholds are 10%, 50%, and 90% between Top and Base values. See “To set measurement thresholds” on page 252 for other percentage threshold and absolute value threshold settings.

The following figure shows time measurement points.

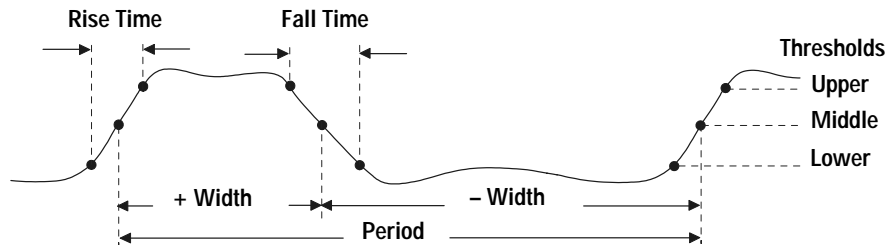

Digital channel time measurements

Automatic time measurements **Delay**, **Fall Time**, **Phase**, **Rise Time**, **X at Max Y**, and **X at Min Y**, and are not valid for digital channels on mixed-signal oscilloscopes.

Counter

The 6000 Series oscilloscopes have an integrated hardware frequency counter which counts the number of cycles that occur within a period of time (known as the *gate time*) to measure the frequency of a signal.

The gate time for the Counter measurement is automatically adjusted to be 100 ms or twice the current time window, whichever is longer, up to 1 second.

The Counter can measure frequencies up to the bandwidth of the oscilloscope. The minimum frequency supported is $1/(2 \times \text{gate time})$.

The measured frequency is normally displayed in 5 digits, but can be displayed in 8 digits when an external 10 MHz frequency reference is provided at the 10 MHz REF rear panel BNC and the gate time is 1 second (50 ms/div sweep speed or greater). See (“To supply a sample clock to the oscilloscope” on page 378.)

The hardware counter uses the trigger comparator output. Therefore, the counted channel’s trigger level (or threshold for digital channels) must be set correctly. The Y cursor shows the threshold level used in the measurement.

Any channel except Math can be selected as the source.

Only one Counter measurement can be displayed at a time.

Duty Cycle

The duty cycle of a repetitive pulse train is the ratio of the positive pulse width to the period, expressed as a percentage. The X cursors show the time period being measured. The Y cursor shows the middle threshold point.

$$\text{Duty cycle} = \frac{\text{Width}}{\text{Period}} \times 100$$

Frequency

Frequency is defined as $1/\text{Period}$. Period is defined as the time between the middle threshold crossings of two consecutive, like-polarity edges. A middle threshold crossing must also travel through the lower and upper threshold levels which eliminates runt pulses. The X cursors show what portion of the waveform is being measured. The Y cursor shows the middle threshold point.

To isolate an event for frequency measurement The following figure shows how to use zoom sweep to isolate an event for a frequency measurement. If the measurement is not possible in the zoom mode, then the normal time base is used. If the waveform is clipped, it may not be possible to make the measurement.

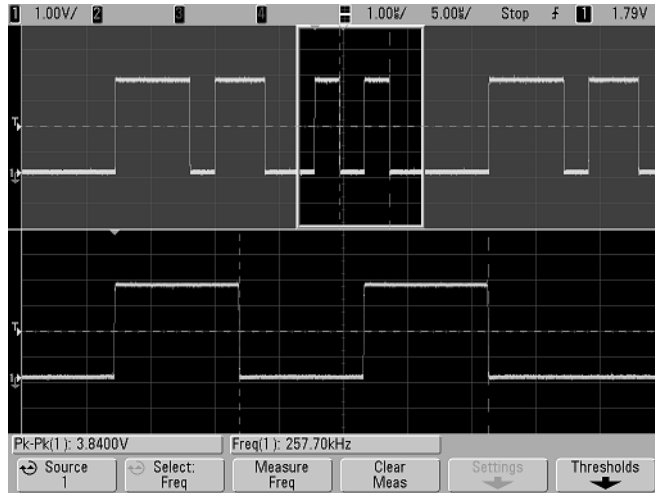

Table 14 Isolating event for Frequency measurement

Period

Period is the time period of the complete waveform cycle. The time is measured between the middle threshold points of two consecutive, like-polarity edges. A middle threshold crossing must also travel through the lower and upper threshold levels which eliminates runt pulses. The X cursors show what portion of the waveform is being measured. The Y cursor shows the middle threshold point.

Fall Time

The fall time of a signal is the time difference between the crossing of the upper threshold and the crossing of the lower threshold for a negative-going edge. The X cursor shows the edge being measured. For maximum measurement accuracy, set

the sweep speed as fast as possible while leaving the complete falling edge of the waveform on the display. The Y cursors show the lower and upper threshold points.

Rise Time

The rise time of a signal is the time difference between the crossing of the lower threshold and the crossing of the upper threshold for a positive-going edge. The X cursor shows the edge being measured. For maximum measurement accuracy, set the sweep speed as fast as possible while leaving the complete rising edge of the waveform on the display. The Y cursors show the lower and upper threshold points.

+ Width

+ Width is the time from the middle threshold of the rising edge to the middle threshold of the next falling edge. The X cursors show the pulse being measured. The Y cursor shows the middle threshold point.

– Width

– Width is the time from the middle threshold of the falling edge to the middle threshold of the next rising edge. The X cursors show the pulse being measured. The Y cursor shows the middle threshold point.

X at Max Y

X at Max Y is the X axis value (usually time) at the first displayed occurrence of the waveform Maximum, starting from the left-side of the display. For periodic signals, the position of the maximum may vary throughout the waveform. The X cursor shows where the current X at Max Y value is being measured.

To measure the peak of an FFT:

- 1 Select **FFT** as the Operator in the **Math** menu.
- 2 Choose **Math: f(t)** as the source in the **Quick Meas** menu.
- 3 Choose **Maximum** and **X at Max Y** measurements.

Maximum units are in dB and **X at Max Y** units are in Hertz for FFT.

X at Min Y

X at Min Y is the X axis value (usually time) at the first displayed occurrence of the waveform Minimum, starting from the left-side of the display. For periodic signals, the position of the minimum may vary throughout the waveform. The X cursor shows where the current X at Min Y value is being measured.

Delay and Phase Measurements

Digital channel measurements

Automatic measurements **Phase**, and **Delay** are not valid for digital channels on the mixed-signal oscilloscope or for the math FFT function. The two sources defined in the phase and delay measurement must be turned on.

Delay

Delay measures the time difference from the selected edge on source 1 and the selected edge on source 2 closest to the trigger reference point at the middle threshold points on the waveforms. Negative delay values indicate that the selected edge of source 1 occurred after the selected edge of source 2.

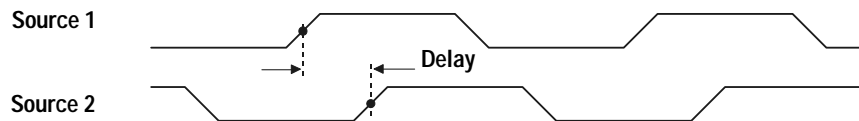

- 1 Press the **Quick Meas&Select** and select **Delay**. Press the **Settings** softkey to select the source channels and slope for the delay measurement.

The default Delay settings measure from the rising edge of channel 1 to the rising edge of channel 2.

- 2 Press the **Measure Delay** softkey to make the measurement.

The following example shows a delay measurement between the rising edge of channel 1 and the rising edge of channel 2.

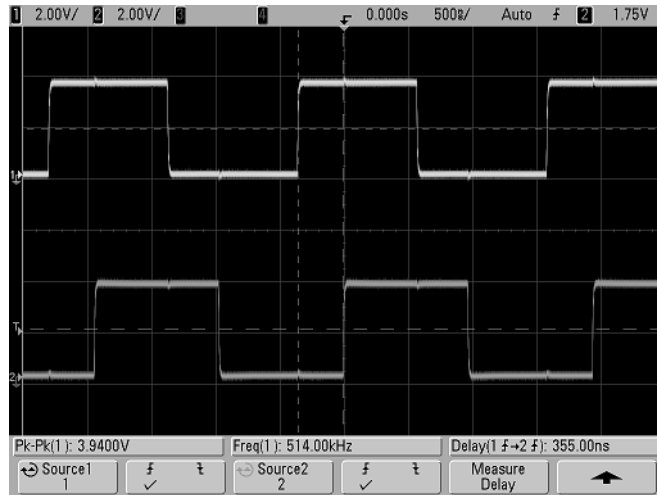
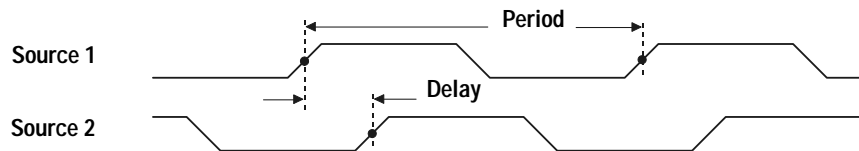

Figure 42 Delay Measurement

Phase

Phase is the calculated phase shift from source 1 to source 2, expressed in degrees. Negative phase shift values indicate that the rising edge of source 1 occurred after the rising edge of source 2.

$$\text{Phase} = \frac{\text{Delay}}{\text{Source 1 Period}} \times 360$$



- 1 Press the **Settings** softkey to select the source 1 and source 2 channels for the phase measurement.

The default Phase settings measure from channel 1 to channel 2.

The example below shows a phase measurement between the channel 1 and the math d/dt function on channel 1.

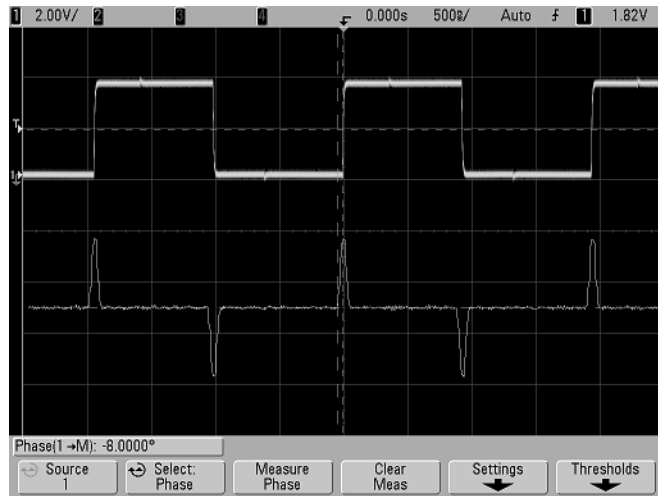

Figure 43 Phase Measurement

Voltage Measurements

Measurement units for each input channel can be set to Volts or Amps using the channel **Probe Units** softkey. A scale unit of **U** (undefined) will be displayed for math function 1-2 and for d/dt, and $\int dt$ when 1-2 or 1+2 is the selected source if channel 1 and channel 2 are set to dissimilar units in the channel **Probe Units** softkey.

Math Measurements and Units

Only Peak-Peak, Maximum, Minimum, Average, X at Min Y, and X at Max Y automatic measurements may be made on a math FFT function. See "Making time measurements automatically" for the FFT X at Max Y and X at Min Y measurement. Use the cursors to make other measurements on FFT. All voltage measurements may be made on other math functions. The resultant units are:

FFT:	dB* (decibels)
1 * 2:	V ² , A ² or W (Volt-Amp)
1 – 2:	V (Volts) or A (Amps)
d/dt:	V/s or A/s (V/second A/second)
∫ dt:	Vs or As (V-seconds or A-seconds)

* When the FFT source is channel 1, 2, 3, or 4, FFT units will be displayed in dBV when channel units is set to Volts and channel impedance is set to 1 MΩ. FFT units will be displayed in dBm when channel units is set to Volts and channel impedance is set to 50Ω. FFT units will be displayed as dB for all other FFT sources or when a source channel's units has been set to Amps.

The following figure shows the voltage measurement points.

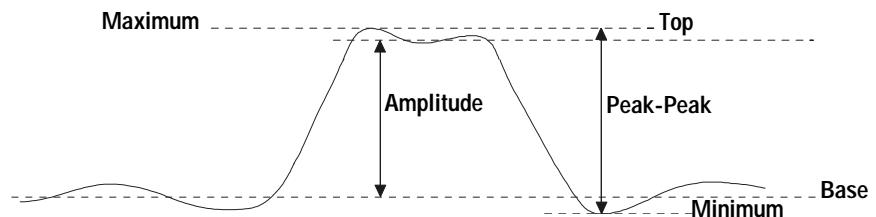

Digital channel voltage measurements

Automatic voltage measurements are not valid on digital channels on the mixed-signal oscilloscope.

Amplitude

The Amplitude of a waveform is the difference between its Top and Base values. The Y cursors show the values being measured.

Average

Average is the sum of the waveform samples divided by the number of samples over one or more full periods. If less than one period is displayed, Average is calculated on the full width of the display. The X cursors show what portion of the displayed waveform is being measured.

$$\text{Average} = \frac{\sum x_i}{n} \quad \begin{array}{l} \text{where } x_i = \text{value at } i\text{th point being measured} \\ n = \text{number of points in measurement interval} \end{array}$$

Base

The Base of a waveform is the mode (most common value) of the lower part of the waveform, or if the mode is not well defined, the base is the same as Minimum. The Y cursor shows the value being measured.

Maximum

Maximum is the highest value in the waveform display. The Y cursor shows the value being measured.

Minimum

Minimum is the lowest value in the waveform display. The Y cursor shows the value being measured.

Peak-Peak

The peak-to-peak value is the difference between Maximum and Minimum values. The Y cursors show the values being measured.

Ratio

The Ratio measurement displays the ratio of the AC RMS voltages of two sources, expressed in dB. Press the **Settings** softkey to select the source channels for the measurement.

RMS

RMS (DC) is the root-mean-square value of the waveform over one or more full periods. If less than one period is displayed, RMS (DC) average is calculated on the full width of the display. The X cursors show what interval of the waveform is being measured.

$$\text{RMS (dc)} = \sqrt{\frac{\sum_{i=1}^n x_i^2}{n}}$$

where x_i = value at i th point being measured
 n = number of points in measurement interval

Std Deviation

The Std Deviation measurement shows the standard deviation of the displayed voltage values. It is an RMS measurement across the full screen with the DC component removed. It is useful, for example, for measuring power supply noise.

The standard deviation of a measurement is the amount that a measurement varies from the mean value. The Mean value of a measurement is the statistical average of the measurement.

The following figure graphically shows the mean and standard deviation. Standard deviation is represented by the Greek letter sigma: σ . For a Gaussian distribution, two sigma ($\pm 1\sigma$) from the mean, is where 68.3 percent of the measurement results reside. Six sigma ($\pm 3\sigma$) from is where 99.7 percent of the measurement results reside.

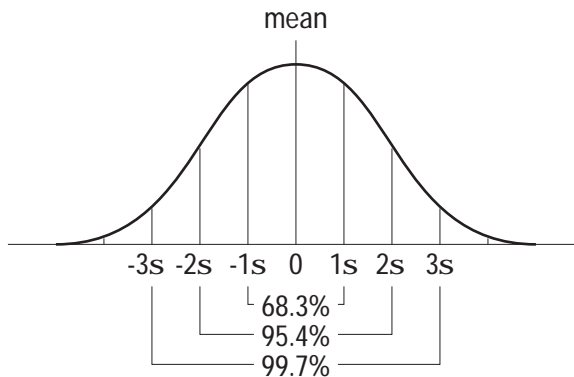

The mean is calculated as follows:

$$\bar{x} = \frac{\sum_{i=1}^N x_i}{N}$$

where:

\bar{x} = the mean.

N = the number of measurements taken.

x_i = the i^{th} measurement result.

The standard deviation is calculated as follows:

$$\sigma = \sqrt{\frac{\sum_{i=1}^N (x_i - \bar{x})^2}{N - 1}}$$

where:

σ = the standard deviation.

N = the number of measurements taken.

x_i = the i^{th} measurement result.

\bar{x} = the mean.

Top

The Top of a waveform is the mode (most common value) of the upper part of the waveform, or if the mode is not well defined, the top is the same as Maximum. The Y cursor shows the value being measured.

To isolate a pulse for Top measurement The following figure shows how to use zoom sweep to isolate a pulse for a **Top** measurement.

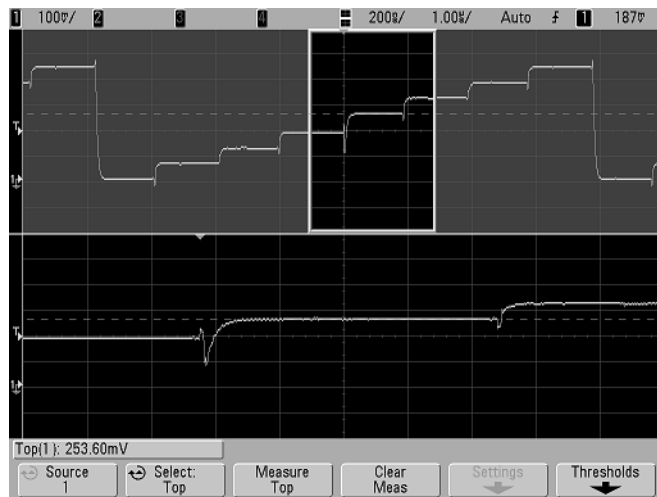

Figure 44 Isolating area for Top measurement

Overshoot and Preshoot Measurements

Digital channel time measurements

Automatic measurements **Preshoot** and **Overshoot** are not valid measurements for the math FFT function or for digital channels on the mixed-signal oscilloscope.

Preshoot

Preshoot is distortion that precedes a major edge transition expressed as a percentage of Amplitude. The X cursors show which edge is being measured (edge closest to the trigger reference point).

$$\text{Rising edge preshoot} = \frac{\text{Base} - \text{D local Minimum}}{\text{Amplitude}} \times 100$$

$$\text{Falling edge preshoot} = \frac{\text{local Maximum} - \text{D Top}}{\text{Amplitude}} \times 100$$

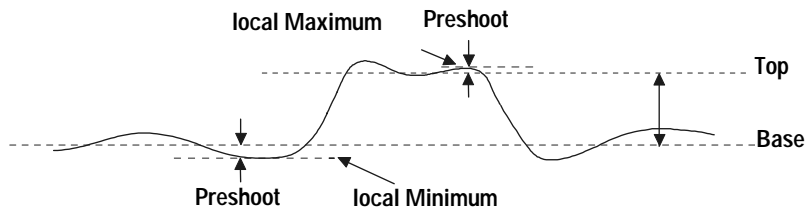

Overshoot

Overshoot is distortion that follows a major edge transition expressed as a percentage of Amplitude. The X cursors show which edge is being measured (edge closest to the trigger reference point).

$$\text{Rising edge overshoot} = \frac{\text{local Maximum} - \text{D Top}}{\text{Amplitude}} \times 100$$

$$\text{Falling edge overshoot} = \frac{\text{Base} - \text{D local Minimum}}{\text{Amplitude}} \times 100$$

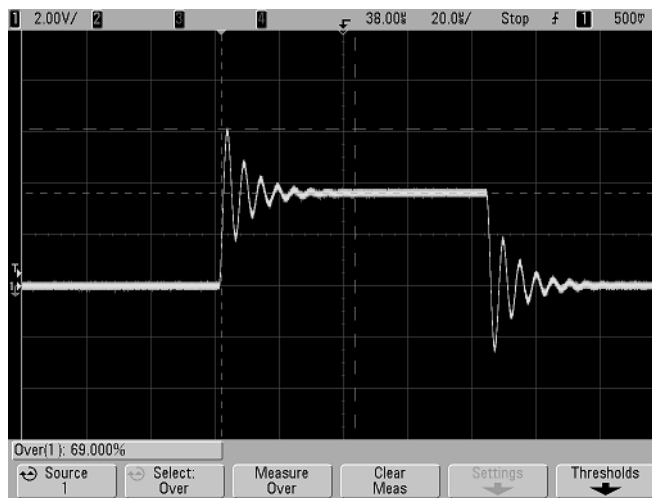
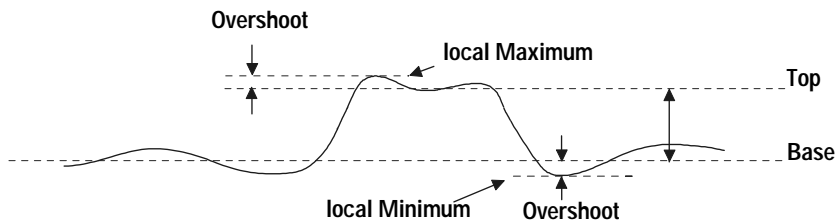
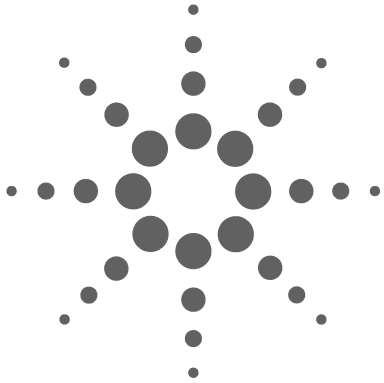

Figure 45 Automatic Overshoot measurement



6 Displaying Data

- Pan and Zoom 270
- Antialiasing 272
- Using the XGA video output 272
- Display Settings 273
- Varying the intensity to view signal detail 275
- Acquisition Modes 277
- Segmented Memory 283
- Using Mask Test 287
- Using Serial Decode 301
 - To decode I²C data 302
 - To decode SPI data 306
 - To decode CAN data 311
 - To decode LIN data 319
 - To decode FlexRay 325
 - To decode UART/RS232 data 336
- To reduce the random noise on a signal 343
- To capture glitches or narrow pulses with peak detect and infinite persistence 345
- How AutoScale Works 348



Pan and Zoom

The ability to pan (move horizontally) and zoom (expand or compress horizontally) an acquired waveform is important because of the additional insight it can reveal about the captured waveform. This additional insight is often gained from seeing the waveform at different levels of abstraction. You may want to view both the big picture and the specific little picture details.

The ability to examine waveform detail after the waveform has been acquired is a benefit generally associated with digital oscilloscopes. Often this is simply the ability to freeze the display for the purpose of measuring with cursors or printing the screen. Some digital oscilloscopes go one step further by including the ability to further examine the signal details after acquiring them by panning and zooming through the waveform.

There is no limit imposed on the zoom ratio between the sweep speed used to acquire the data and the sweep speed used to view the data. There is, however, a useful limit. This useful limit is somewhat a function of the signal you are analyzing.

In normal display mode, with vectors (connect-the-dots) off, you can zoom in to the point where there are no samples on the screen. Obviously, this is far beyond the useful limit. Likewise, with vectors on, you can see the linear interpolation between the points, but again, this is of very limited value.

Zoom

The screen will still contain a relatively good display if you zoom in horizontally by a factor of 1000 and zoom in vertically by a factor of 10 to display the information from where it was acquired. Remember that you can only make automatic measurements on displayed data.

To pan and zoom a waveform

- 1 Press the **Run/Stop** key to stop acquisitions. The **Run/Stop** key is illuminated red when the oscilloscope is stopped.
- 2 Turn the sweep speed knob to zoom horizontally and turn the volts/division knob to zoom vertically.

The ∇ symbol at the top of the display indicates the time reference point where the zoom-in/zoom-out is referenced.

- 3 Turn the Horizontal Position knob ($\blacktriangleleft\blacktriangleright$) to pan horizontally and turn the channel's vertical position knob (\blacklozenge) to pan vertically.

The stopped display may contain several triggers worth of information, but only the last trigger acquisition is available for pan and zoom.

To set the waveform expansion reference point

When you change a channel's volts/division setting, the waveform display can be set to expand (or compress) about the signal ground level or the center of the display.

Expand About Ground The displayed waveform will expand about the position of the channel's ground. This is the default setting. The ground level of the signal is identified by the position of the ground level ($\text{—}\blacktriangleleft$) icon at the far-left side of the display. The ground level will not move when you adjust the vertical sensitivity (volts/division) control.

If the ground level is off screen, the waveform will expand about the top or bottom edge of the screen based on where the ground is off screen.

Expand About Center The displayed waveform will expand about the center of the display.

To set the waveform expansion reference point

Press **Utility&Options&Preferences&Expand** and select **Ground or Center**.

Antialiasing

At slower sweep speeds, the sample rate is reduced and a proprietary display algorithm is used to minimize the likelihood of aliasing.

By default, Antialiasing is enabled. You should leave Antialiasing enabled unless there is a specific reason to switch it off.

If you need to switch Antialiasing off, press **Utilities&Options&Preferences** and press the **Antialiasing** softkey to switch the feature off. The displayed waveforms will be more susceptible to aliasing.

Using the XGA video output

A standard XGA video output connector is provided on the rear panel. You can connect a monitor to provide a larger display, or to provide a display at a viewing position away from the oscilloscope.

The oscilloscope's built-in display will remain on even when an external display is connected.

For optimal video quality and performance we recommend you use a shielded video cable with ferrite cores.

Display Settings

- Press the **Display** key to view the Display menu.

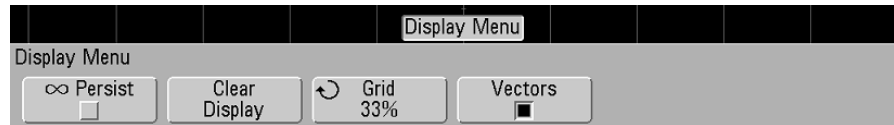

To manually control Display settings on 6000L models start the Remote Front Panel (see page 49) and select **Waveform** from the Main Menu or press ctrl+W to access the oscilloscope's Display Menu.

Infinite persistence

With infinite persistence, the oscilloscope updates the display with new acquisitions, but does not erase the results of previous acquisitions. All previous acquisitions are displayed in gray with reduced intensity. New acquisitions are shown in their normal color with normal intensity. Waveform persistence is kept only for the current display area; you can not pan and zoom the infinite persistence display.

Use infinite persistence to measure noise and jitter, to see the worst-case extremes of varying waveforms, to look for timing violations, or to capture events that occur infrequently.

To use infinite persistence to display multiple repetitive events

- 1 Connect a signal to the oscilloscope.
- 2 Press the **Display** key, then press ∞ **Persist** to turn on infinite persistence. The display will begin accumulating multiple acquisitions. The accumulated waveforms are shown in gray with reduced intensity.
- 3 Press the **Clear Display** softkey to erase previous acquisitions. The oscilloscope will again start to accumulate acquisitions.
- 4 Turn off infinite persistence, then press the **Clear Display** key to return the oscilloscope to the normal display mode.

Accumulating multiple acquisitions

Turning off infinite persistence does not clear the display. This allows you to accumulate multiple acquisitions, stop acquisitions, and then compare future acquisitions to the stored waveforms.

Clearing stored infinite persistence waveforms

In addition to clearing the display by pressing the **Clear Display** softkey, the display is also cleared of previous acquisitions if you press the **AutoScale** key.

Grid intensity

To adjust the grid (graticule) intensity, press **Display&Grid** and use the Entry knob  to adjust the intensity.

Vectors (connect the dots)

The Agilent 6000 Series oscilloscopes are designed to operate optimally with vectors on. This mode gives the most realistic waveforms in most situations.

When enabled, **Vectors** draws a line between consecutive waveform data points.

- Vectors give an analog look to a digitized waveform.
- Vectors allow you to see steep edges on waveforms, such as square waves.
- Vectors allow subtle detail of complex waveforms to be viewed, much like an analog oscilloscope trace, even when the detail is just a small number of pixels in size.

The oscilloscope switches vectors on whenever the acquisition system stops. Digital channels on the mixed-signal oscilloscope are not affected by the Display menu. They are always displayed with peak detect and vectors on. They also only contain one trigger worth of information.

Using Vectors (Display menu)

One of the most fundamental choices you must make about your display is whether to draw vectors (connect the dots) between the samples, or simply let the samples fill in the waveform. To some degree, this is a matter of personal preference, but it also depends on the waveform.

- You will probably operate the oscilloscope most often with vectors on. Complex analog signals like video and modulated signals show analog-like intensity information with vectors on.
- Turn vectors off when highly complex or multivalued waveforms are displayed. Turning vectors off may aid the display of multivalued waveforms such as eye diagrams.
- Having vectors on does not slow down the display rate.

Varying the intensity to view signal detail

The **Intensity** knob lets you adjust the plotted waveforms to account for various signal characteristics, such as fast sweep speeds and low trigger rates. Increasing the intensity lets you see the maximum amount of noise and infrequently occurring events. Reducing the intensity can expose more detail in complex signals as shown in the following figures. The intensity knob does not affect the digital channels.

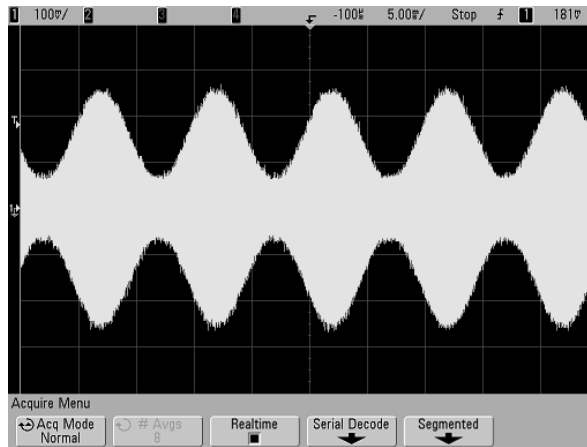

Figure 46 Amplitude Modulation with Noise Shown at 100% Intensity

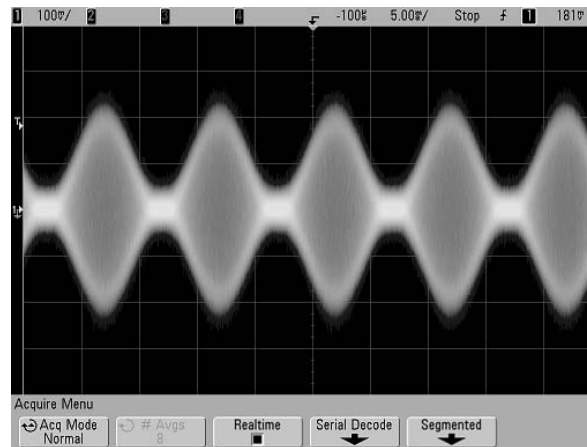

Figure 47 Amplitude Modulation with Noise Shown at 40% Intensity

Acquisition Modes

The 6000 Series oscilloscopes have the following acquisition modes:

- **Normal** – for most waveforms (with normal decimating at slower sweep speeds, no averaging).
- **Peak Detect** – for displaying narrow pulses that occur infrequently (at slower sweep speeds).
- **Averaging** – for reducing noise and increasing resolution (at all sweep speeds, without bandwidth or rise time degradation).
- **High Resolution** – for reducing random noise (at slower sweep speeds).

Realtime sampling (where the oscilloscope produces the waveform display from samples collected during one trigger event) can be turned off or on in the Normal, Peak Detect, and High Resolution modes.

At Slower Sweep Speeds

At slower sweep speeds, the sample rate drops because the acquisition time increases and the oscilloscope's digitizer is sampling faster than is required to fill memory.

For example, suppose an oscilloscope's digitizer has a sample period of 1 ns (maximum sample rate of 1 GSa/s) and a 1 M memory depth. At that rate, memory is filled in 1 ms. If the acquisition time is 100 ms (10 ms/div), only 1 of every 100 samples is needed to fill memory.

Selecting the Acquisition mode

To select the acquisition mode on 6000A Series oscilloscopes press the Acquire key on the front panel.

To manually control the acquisition mode on 6000L models start the Remote Front Panel (see page 49) and select **Waveform** from the Main Menu or press ctrl+A to access the oscilloscope's Acquire Menu.

Normal Mode

In Normal mode at slower sweep speeds, extra samples are decimated (in other words, some are thrown away). This mode yields the best display for most waveforms.

Peak Detect Mode

In Peak Detect mode at slower sweep speeds, minimum and maximum samples are kept in order to capture infrequent and narrow events (at the expense of exaggerating any noise). This mode displays all pulses that are at least as wide as the sample period (see Table 15).

Table 15 Agilent 6000 Series Model Numbers and Sampling Rates

Bandwidth	100 MHz	300 MHz	500 MHz	1 GHz
Maximum Sample Rate	2 GSa/s	2 GSa/s	4 GSa/s	4 GSa/s
A sample is taken every (sample period)	500 ps	500 ps	250 ps	250 ps
2-Channel DSO	DSO6012A	DSO6032A	DSO6052A	DSO6102A
4-Channel DSO	DSO6014A	DSO6034A	DSO6054A	DSO6104A
2-Channel + 16 Logic Channels MSO	MSO6012A	MSO6032A	MSO6052A	MSO6102A
4-Channel + 16 Logic Channels MSO	MSO6014A	MSO6034A	MSO6054A	MSO6104A
4-Channel DSO	DSO6014L		DSO6054L	DSO6104L

High Resolution Mode

In High Resolution mode, at slower sweep speeds extra samples are averaged in order to reduce random noise, produce a smoother trace on the screen, and effectively increase vertical resolution.

High Resolution mode averages sequential sample points within the same acquisition together. An extra bit of vertical resolution is produced for every factor of 4 averages. The number of extra bits of vertical resolution is dependent on the time per division setting (sweep speed) of the scope.

The slower the sweep speed, the greater the number of samples that are averaged together for each display point.

High Resolution mode can be used on both single-shot and repetitive signals and it does not slow waveform update because the computation is done in the MegaZoom custom ASIC. High Resolution mode limits the scope's real-time bandwidth because it effectively acts like a low-pass filter.

2 GSa/s Sample Rate	4 GSa/s Sample Rate	Bits of resolution
≤ 50 ns/div	≤ 50 ns/div	8
200 ns/div	100 ns/div	9
1 us/div	500 ns/div	10
5 us/div	2 us/div	11
≥ 20 us/div	≥ 10 us/div	12

Averaging Mode

The Averaging mode lets you average multiple acquisitions together to reduce noise and increase vertical resolution (at all sweep speeds). Averaging requires a stable trigger.

The number of averages can be set from 2 to 65536 in powers-of-2 increments.

A higher number of averages reduces noise more and increases vertical resolution.

# Avgs	Bits of resolution
2	8
4	9
16	10
64	11
≥ 256	12

The higher the number of averages, the slower the displayed waveform responds to waveform changes. You must compromise between how quickly the waveform responds to changes and how much you want to reduce the displayed noise on the signal.

To use the Averaging mode

- 1 Press the **Acquire** key, then press the **Acq Mode** softkey until the Averaging mode is selected.
- 2 Press the **#Avgs** softkey and turn the Entry knob to set the number of averages that best eliminates the noise from the displayed waveform. The number of acquisitions being averaged is displayed in the **# Avgs** softkey.

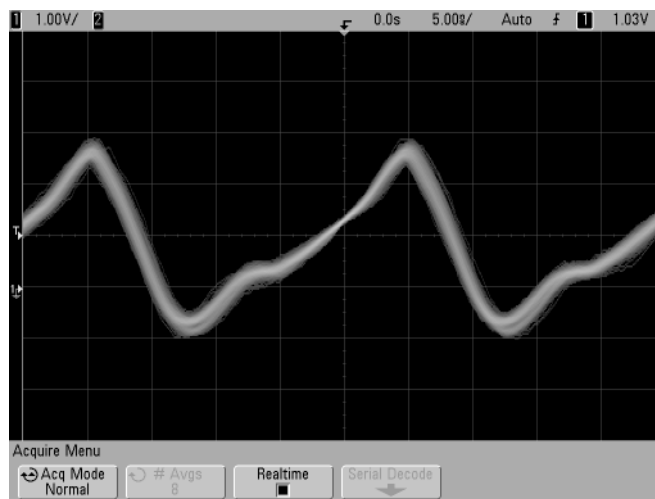

Figure 48 Random noise on the displayed waveform

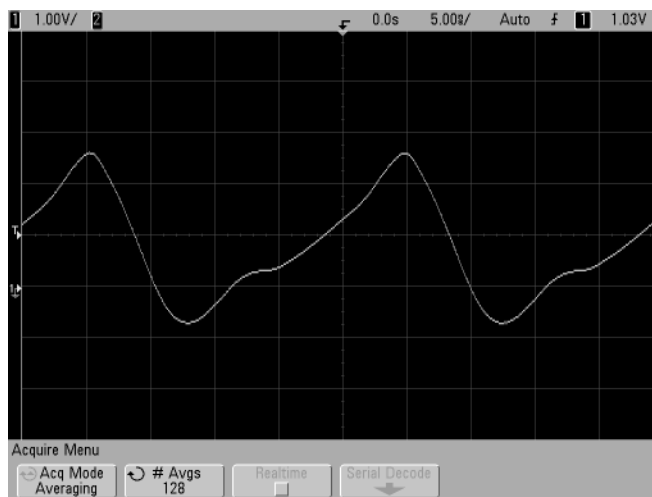

Figure 49 128 Averages used to reduce random noise

Realtime Sampling Option

Realtime sampling specifies that the oscilloscope produce the waveform display from samples collected during one trigger event (that is, one acquisition).

Use Realtime sampling to capture infrequent triggers, unstable triggers, or complex changing waveforms, such as eye diagrams.

Realtime sampling can be turned on in **Normal**, **Peak Detect**, or **High Resolution** acquisition modes. It cannot be turned on when the acquisition mode is **Averaging**.

When Realtime sampling is on (as in the default setup):

- When less than 1000 samples can be collected in the time spanned by the screen, a sophisticated reconstruction filter is used to fill in and enhance the waveform display.
- If you press the **Stop** key, and pan and zoom through the waveform using the Horizontal and Vertical controls, only the last trigger's acquisition will be displayed.

When Realtime sampling is off:

- The oscilloscope produces the waveform display from samples collected from multiple acquisitions. In this case, the reconstruction filter is not used.

Realtime Sampling and Oscilloscope Bandwidth

To accurately reproduce a sampled waveform, the sample rate should be at least four times the highest frequency component of the waveform. If not, it is possible for the reconstructed waveform to be distorted or aliased. Aliasing is most commonly seen as jitter on fast edges.

The maximum sample rate for 100 MHz and 300 MHz bandwidth oscilloscopes is 2 GSa/s.

The maximum sample rate for 1 GHz and 500 MHz bandwidth oscilloscopes is 4 GSa/s for a single channel in a channel pair. Channels 1 and 2 constitute a channel pair, and channels 3 and 4 constitute another channel pair. For example, the sample rate of a 4-channel oscilloscope is 4 GSa/s when channels 1 and 3, 1 and 4, 2 and 3, or 2 and 4 are on.

Whenever both channels in a channel pair are on, the sample rate for all channels is halved. For example, when channels 1, 2, and 3 are on, the sample rate for all channels is 2 GSa/s.

When Realtime sampling is on, the bandwidth of the oscilloscope is limited because the bandwidth of the reconstruction filter is set to $f_s/4$. For example, a 610x oscilloscope with channels 1 and 2 on has a bandwidth of 500 MHz when Realtime sampling on and 1 GHz when Realtime sampling is off.

To see the sample rate, press the **Menu/Zoom** key on the front panel. The sample rate is displayed in the line just above the softkeys.

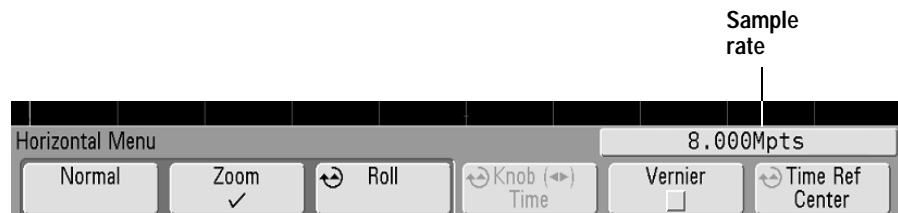

Segmented Memory

You can purchase the oscilloscope with the segmented memory option factory-installed (Option SGM) or you can easily install it yourself (order model number N5454A “Segmented Memory”).

When capturing multiple infrequent trigger events it is advantageous to divide the oscilloscope’s memory into segments. This lets you capture signal activity without capturing long periods of signal “dead time.”

Each segment is complete with all analog channel, digital channel (on MSO models), and serial decode data.

When using Segmented memory, use the Analyze Segments feature (see “Measurements, statistics, and infinite persistence” on page 285) to show infinite persistence across all acquired segments. See also “Infinite persistence” on page 273 for details.

Using segmented memory

- 1 Set up a trigger condition. (See “Triggering the Oscilloscope” on page 135 for details.)
- 2 Press the **Acquire** key in the Waveform section of the front panel.
- 3 Press the **Segmented** softkey to access the Segmented Memory Menu.
- 4 In the Segmented Memory Menu, press the **Segmented** softkey to enable segmented memory acquisitions.
- 5 Press the **# of Segs** softkey and rotate the Entry knob to select the number of segments into which you would like to divide the oscilloscope’s memory. Memory can be divided into as few as two segments and as many as 2000 segments.
- 6 Press the **Run** key or the **Single** key.

The oscilloscope will run and fill a memory segment for each trigger event. When the oscilloscope is busy acquiring multiple segments, the progress is displayed in the upper right area of the display. The oscilloscope will continue to trigger until memory is filled, then the oscilloscope will stop.

If the signal you are measuring has more than about 1 s of “dead time” (inactivity), consider selecting **Normal** trigger mode to prevent AutoTriggering. Press the **Mode/Coupling** key, then press the **Mode** softkey and select **Normal**.

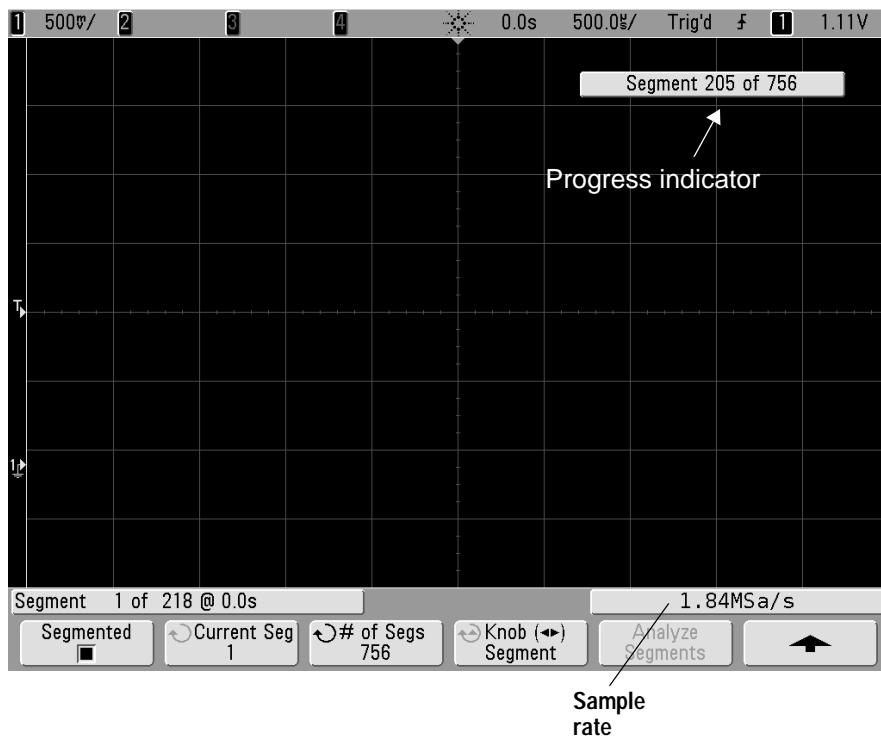

Navigating segments

Press the **Current Seg** softkey and turn the Entry knob to display to the desired segment along with a time tag indicating the time from the first trigger event.

You can also press the **Knob** softkey to toggle between **Current Segment** and **Time**. When **Current Segment** is selected, the Horizontal position control knob moves the display to the desired segment. When **Time** is selected, the Horizontal position control knob moves the display horizontally just as it does when Segmented Memory mode is not selected. The **Knob** softkey also appears in the Horizontal menu so you can make the same adjustments there.

Measurements, statistics, and infinite persistence

To perform measurements and view statistical information, press **Quick Meas** and set up your desired measurements. (See “Automatic Measurements” on page 246.) Then press **Analyze Segments**. Statistical data will be accumulated for the measurements you have chosen.

The **Analyze Segments** softkey only appears when the acquisition is stopped and the optional segmented memory feature is on.

You can also switch on infinite persistence (in the Display menu) and press the **Analyze Segments** softkey to create an infinite persistence display.

Re-arm time

After each segment fills, the oscilloscope re-arms and is ready to trigger in about 8 μs . Remember though, for example: if the horizontal time per division control is set to 5 $\mu\text{s}/\text{div}$, and the Time Reference is set to **Center**, it will take at least 50 μs to fill all ten divisions and re-arm. (That’s 25 μs to capture pre-trigger data and 25 μs to capture post-trigger data.)

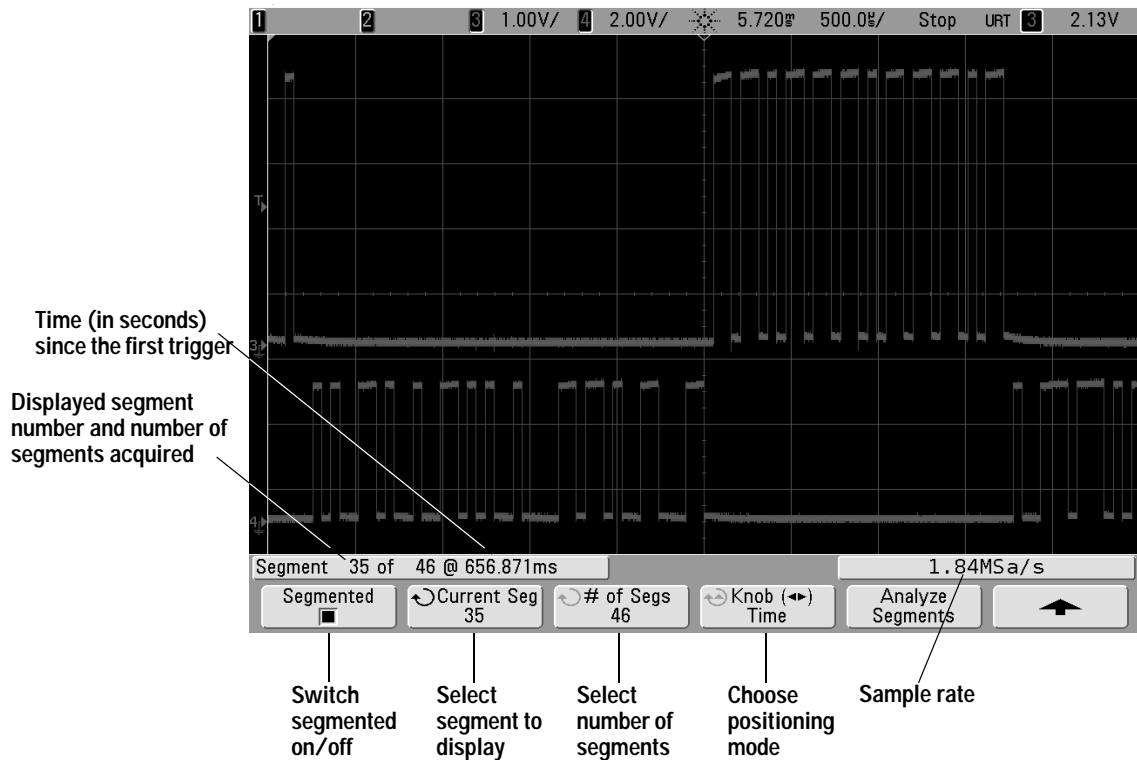

Saving data from segmented memory

You can save either the currently displayed segment (**Save Segment - Current**), or all segments (**Save Segment - All**) in the following data formats: CSV, ASCII XY, and BIN. Be sure to set the Length control to capture enough points to accurately represent the captured data. When the oscilloscope is busy saving multiple segments, progress is displayed in the upper right area of the display.

To select the current segment or all segments, press **Save/Recall**→**Save**→**Settings**→**Save Seg**. A USB storage device must be connected to the oscilloscope to enable this Save option. You can also save the screen image in BMP or PNG formats. For more information see “Save Segment” on page 364.

Using Mask Test

One way to verify a waveform's compliance to a particular set of parameters is to use mask testing. A mask defines a region of the scope's display in which the waveform must remain in order to comply with chosen parameters. Compliance to the mask is verified point-by-point across the display. Mask test operates on displayed analog channels; it does not operate on channels that are not displayed.

To enable mask test order option LMT at time of oscilloscope purchase, or order N5455A as a stand-alone item after oscilloscope purchase.

To create a mask from a “golden” waveform

A golden waveform meets all chosen parameters, and it is the waveform to which all others will be compared.

- 1 Configure the oscilloscope to display the golden waveform.
- 2 Press the **Acquire** key.
- 3 Press the **Mask Test** softkey (in the Acquire menu) to enter the mask test menu.

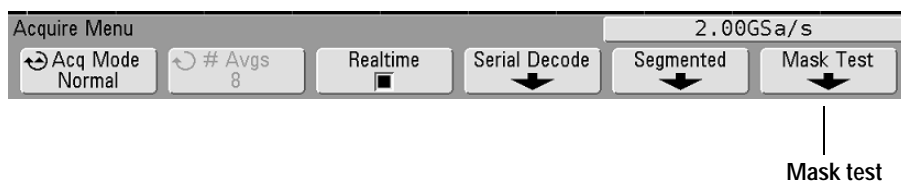

- 4 Press the **Automask** softkey.

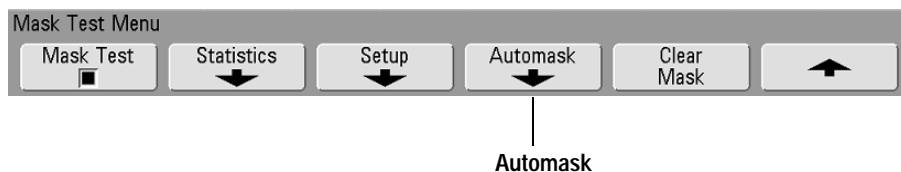

- 5 Press the **Source** softkey and ensure the analog channel from which to create the mask is selected.
- 6 Adjust the mask's horizontal tolerance ($\pm Y$) and vertical tolerance ($\pm X$). These are adjustable in graticule divisions or

in absolute units (volts or seconds), selectable using the **Units** softkey.

- 7 Press the **Create Mask** softkey. The mask is created and testing begins. Whenever the **Create Mask** key is pressed the old mask is erased and a new mask is created.

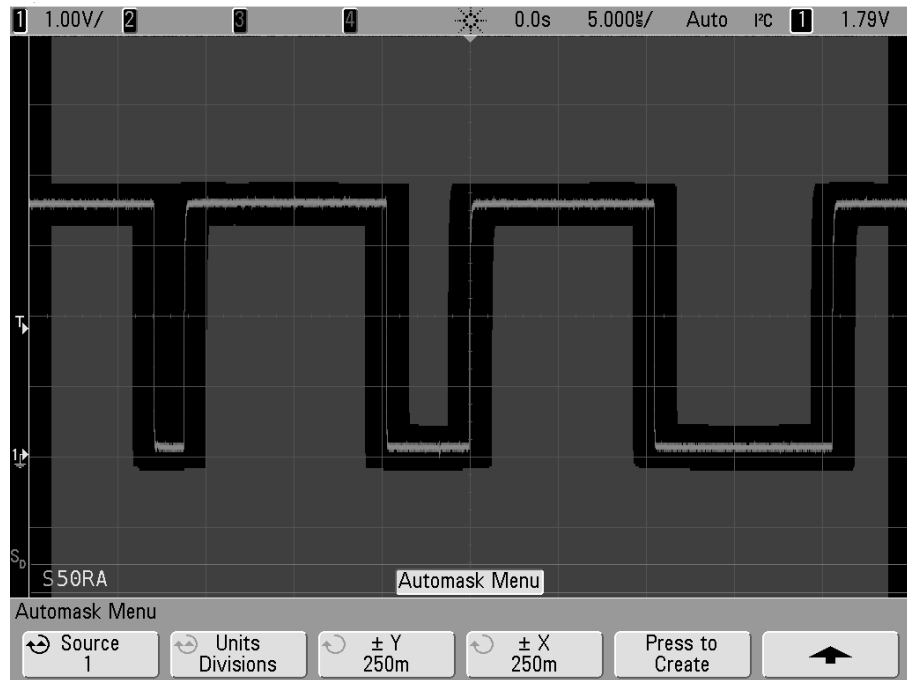

- 8 To clear the mask and switch off mask testing, press the up arrow softkey to return to the **Mask Test** menu, then press the **Clear Mask** softkey.

If infinite persistence display mode (see “Infinite persistence” on page 273) is “on” when mask test is enabled, it stays on. If infinite persistence is “off” when mask test is enabled, it is switched on when mask test is switched on, then infinite persistence is switched off when mask test is switched off.

Setup Options

Run Until

The Run Until softkey lets you specify a condition on which to terminate testing.

Forever The oscilloscope runs continuously. However, if an error occurs the action specified using the **On Error** softkey will occur.

Minimum # of Tests Choose this option and then use the **# of Tests** softkey to select the number of times the oscilloscope will trigger, display the waveform(s), and compare them to the mask. The oscilloscope will stop after the specified number of tests have been completed. The specified minimum number of tests may be exceeded. If an error occurs the action specified using the **On Error** softkey will occur. The actual number of tests completed is displayed above the softkeys.

Minimum Time Choose this option and then use the **Test Time** softkey to select how long the oscilloscope will run. When the selected time has passed the oscilloscope will stop. The specified time may be exceeded. If an error occurs the action specified using the **On Error** softkey will occur. The actual test time is displayed above the softkeys.

Minimum Sigma Choose this option and then use the **Sigma** softkey to select a minimum sigma. The mask test runs until enough waveforms are tested to achieve a minimum test sigma. (If an error occurs the oscilloscope will perform the action specified by the **On Error** softkey.) Note that this is a test sigma (the max achievable process sigma, assuming no defects, for a certain number of tested waveforms) as opposed to a process sigma (which is tied to the amount of failures per test). The sigma value may exceed the selected value when a small sigma value is chosen. The actual sigma is displayed.

On Error

The **On Error** setting specifies the action to take when the input waveform does not conform to the mask. This setting supersedes the **Run Until** setting.

Stop The oscilloscope will stop when the first error is detected (on the first waveform that does not conform to the mask). This setting supersedes the **Minimum # of Tests** and **Minimum Time** settings.

Save The oscilloscope will save based on the settings you have chosen. See “Saving oscilloscope data” on page 356.

Print The oscilloscope will print the waveform display when the first error is detected. This option is only available when a printer is connected as described in “To print the oscilloscope’s display” on page 353.

Note that you can choose to Print or Save, but you can not select both.

Source Lock

When you turn on Source Lock using the **Source Lock** softkey, the mask is redrawn to match the source whenever you move the waveform. For example: if you change the horizontal timebase or the vertical gain the mask is redrawn with the new settings.

When you turn off Source Lock, the mask is not redrawn when horizontal or vertical settings are changed.

The Source softkey in the Mask Setup Menu is the same as the Source softkey in the Automask Menu.

Mask Test Trigger Output

The oscilloscope's trigger output (located on the rear panel) can be activated by mask test results.

Press **Utility**→**Options**→**Rear Panel**→**Trig Out** and select **Mask**. Use the **Mask Out** softkey to select the desired mode.

Table 16

Run mode	Mask Out setting	Trigger Output (rear panel)
Single	Pass	A pulse is produced if the mask test passed.
Single	Fail	A pulse is produced if the mask test failed.
Run	Pass	A pulse is produced if all mask tests have passed
Run	Fail	A pulse is produced if any mask test has failed

The Pass/fail status is evaluated periodically. When the evaluation of the testing period results in a pulse output, the trigger output pulses high (+ 5 V). Otherwise, the trigger output remains at low (0 V).

Statistics

From the Mask Test Menu, press the **Statistics** softkey to enter the Mask Statistics Menu.

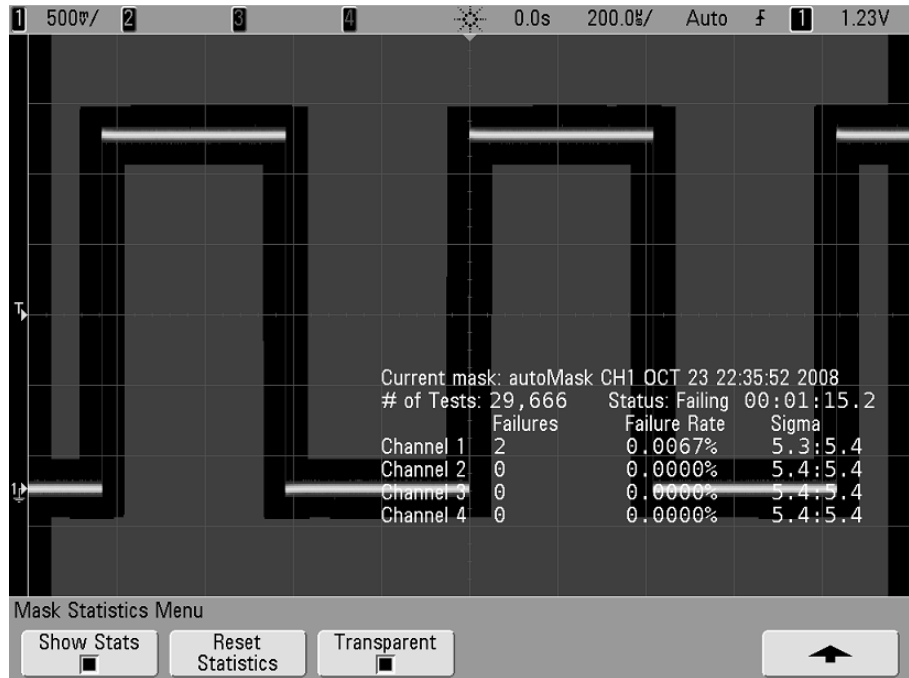

When you enable **Show Statistics** the following information is displayed:

- Current mask, name of mask, Channel number, date and time
- # of Tests (total number of mask tests executed)
- Status (Passing, Failing, or Untested)
- Accumulated test time (in hours, minutes, seconds, and tenths of seconds)

And for each analog channel:

- Number of failures (acquisitions in which the signal excursion went beyond the mask)
- Failure rate (percentage of failures)

- Sigma (the ratio of process sigma to maximum achievable sigma, based on number of waveforms tested)

Reset Statistics

Press this softkey to reset the statistics counters to zero.

Note that statistics are also reset when:

- Mask Test is switched on after being switched off
- Clear Mask softkey is pressed
- An Automask is created

Additionally, the accumulated time counter is reset whenever the oscilloscope is run after the acquisition was stopped.

Transparent

Enable Transparent mode to write measurement values and statistics on the screen without a background. Disable the Transparent mode to show them with a light blue background. This controls the display of statistics for both Quick Meas and the optional Mask test feature.

To manually modify a mask file

You can manually modify a mask file that you created using the Automask function.

- 1 Follow the steps 1-7 in “To create a mask from a “golden” waveform” on page 287. Do not clear the mask after creating it.
- 2 Attach a USB mass storage device to the oscilloscope.
- 3 Press the **Save/Recall** key.
- 4 Press the **Save** softkey.
- 5 Press the **Format** softkey and select **Mask**.
- 6 Press the second softkey and select a destination folder on your USB mass storage device.
- 7 Press the **Press to Save** softkey. This creates an ASCII text file that describes the mask.
- 8 Remove the USB mass storage device and connect it to a PC.

9 Open the .msk file you created using a text editor (such as Wordpad).

10 Edit, save, and close the file.

The mask file contains the following sections:

- Mask File Identifier
- Mask Title
- Mask Violation Regions
- Oscilloscope Setup Information

Mask File Identifier

The Mask File Identifier is MASK_FILE_548XX.

Mask Title

The Mask Title is a string of ASCII characters.

Example: autoMask CH1 OCT 03 09:40:26 2008

When a mask file contains the keyword “autoMask” in the title, the edge of the mask is passing by definition. Otherwise, the edge of the mask is defined as a failure.

Mask Violation Regions

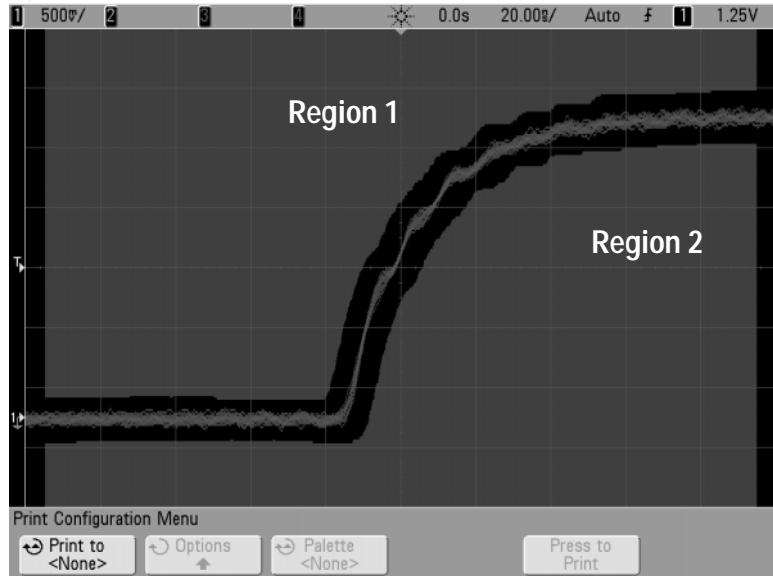

Up to 8 regions can be defined for a mask. They can be numbered 1-8. They can appear in any order in the .msk file. The numbering of the regions must go from top to bottom, left to right. The lowest numbered region

An Automask file contains two special regions: the region “glued” to the top of the display, and the region that is “glued” to the bottom. The top region is indicated by y-values of “MAX” for the first and last points. The bottom region is indicated by y-values of “MIN” for the first and last points.

The top region must be the lowest numbered region in the file. The bottom region must be the highest numbered region in the file.

Region number 1 is the top mask region. The vertices in Region 1 describe points along a line; that line is the bottom edge of the top portion of the mask.

Similarly, the vertices in Region 2 describe the line that forms the top of the bottom part of the mask.

The vertices in a mask file are normalized. There are four parameters that define how values are normalized:

- X1
- ΔX
- Y1
- Y2

These four parameters are defined in the Oscilloscope Setup portion of the mask file.

The Y-values (normally voltage) are normalized in the file using the following equation:

$$Y_{\text{norm}} = (Y - Y1) / \Delta Y$$

$$\text{where } \Delta Y = Y2 - Y1$$

To convert the normalized Y-values in the mask file to voltage:

$$Y = (Y_{\text{norm}} * \Delta Y) + Y1$$

$$\text{where } \Delta Y = Y2 - Y1$$

The X-values (normally time) are normalized in the file using the following equation:

$$X_{\text{norm}} = (X - X1) / \Delta X$$

To convert the normalized X-values to time:

$$X = (X_{\text{norm}} * \Delta X) + X1$$

Oscilloscope Setup Information

The keywords “setup” and “end_setup” (appearing alone on a line) define the beginning and end of the oscilloscope setup region of the mask file. The oscilloscope setup information contains remote programming language commands that the oscilloscope executes when the mask file is loaded.

Any legal remote programming command can be entered in this section.

The mask scaling controls how the normalized vectors are interpreted. This in turn controls how the mask is drawn on the display. The remote programming commands that control mask scaling are:

```
:MTES:SCAL:BIND 0
```

```
:MTES:SCAL:X1 -400.000E-06
```

```
:MTES:SCAL:XDEL +800.000E-06
```

```
:MTES:SCAL:Y1 +359.000E-03
```

```
:MTES:SCAL:Y2 +2.35900E+00
```

Building A Mask File

The following mask uses all eight mask regions. The most difficult part of creating a mask file is normalizing the X and Y values from the time and voltage values. This example shows an easy way to convert voltage and time to normalized X and Y values in the mask file.

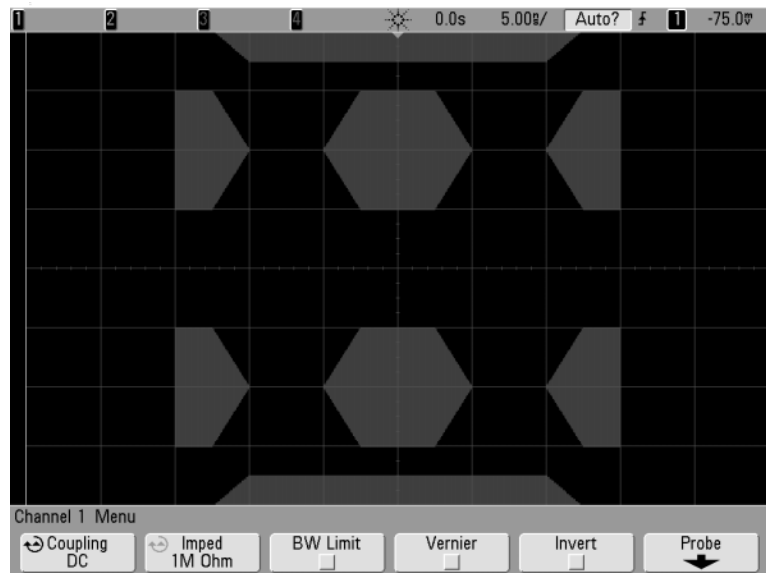

The following mask file produced the mask shown above:

MASK_FILE_548XX

"All Regions"

```
/* Region Number */ 1
/* Number of vertices */ 4
-12.50, MAX
-10.00, 1.750
10.00, 1.750
12.50, MAX
```

```
/* Region Number */ 2
/* Number of vertices */ 5
-10.00, 1.000
-12.50, 0.500
-15.00, 0.500
-15.00, 1.500
-12.50, 1.500
```

```
/* Region Number */ 3
/* Number of vertices */ 6
-05.00, 1.000
-02.50, 0.500
02.50, 0.500
05.00, 1.000
02.50, 1.500
-02.50, 1.500
```

```
/* Region Number */ 4
/* Number of vertices */ 5
10.00, 1.000
12.50, 0.500
15.00, 0.500
15.00, 1.500
12.50, 1.500
```

```
/* Region Number */ 5
/* Number of vertices */ 5
-10.00, -1.000
-12.50, -0.500
-15.00, -0.500
-15.00, -1.500
-12.50, -1.500
```

```
/* Region Number */ 6
```

```
/* Number of vertices */ 6
```

```
-05.00, -1.000
-02.50, -0.500
02.50, -0.500
05.00, -1.000
02.50, -1.500
-02.50, -1.500
```

```
/* Region Number */ 7
```

```
/* Number of vertices */ 5
```

```
10.00, -1.000
12.50, -0.500
15.00, -0.500
15.00, -1.500
12.50, -1.500
```

```
/* Region Number */ 8
```

```
/* Number of vertices */ 4
```

```
-12.50, MIN
-10.00, -1.750
10.00, -1.750
12.50, MIN
```

```
setup
```

```
:MTES:ENAB 1
```

```
:CHAN1:RANG +4.00E+00;OFFS +0.0E+00;COUP DC;IMP ONEM;DISP 1;BWL 0;INV 0
:CHAN1:LAB "1";UNIT VOLT;PROB +1.0E+00;PROB:SKEW +0.0E+00;STYP SING
:CHAN2:RANG +16.0E+00;OFFS +1.62400E+00;COUP DC;IMP FIFT;DISP 0;BWL 0;INV 0
:CHAN2:LAB "2";UNIT VOLT;PROB +1.0E+00;PROB:SKEW +0.0E+00;STYP SING
:CHAN3:RANG +40.0E+00;OFFS +0.0E+00;COUP DC;IMP ONEM;DISP 0;BWL 0;INV 0
:CHAN3:LAB "3";UNIT VOLT;PROB +1.0E+00;PROB:SKEW +0.0E+00;STYP SING
:CHAN4:RANG +40.0E+00;OFFS +0.0E+00;COUP DC;IMP ONEM;DISP 0;BWL 0;INV 0
:CHAN4:LAB "4";UNIT VOLT;PROB +1.0E+00;PROB:SKEW +0.0E+00;STYP SING
:EXT:BWL 0;IMP ONEM;RANG +5E+00;UNIT VOLT;PROB +1.0E+00;PROB:STYP SING
:TIM:MODE MAIN;REF CENT;MAIN:RANG +50.00E-09;POS +0.0E+00
:TRIG:MODE EDGE;SWE AUTO;NREJ 0;HFR 0;HOLD +60E-09
:TRIG:EDGE:SOUR CHAN1;LEV -75.00E-03;SLOP POS;REJ OFF;COUP DC
:ACQ:MODE RTIM;TYPE NORM;COMP 100;COUNT 8;SEGM:COUN 2
:DISP:LAB 0;CONN 1;PERS MIN;SOUR PMEM1
:HARD:APR "";AREA SCR;FACT 0;FFE 0;INKS 1;PAL NONE;LAY PORT
:SAVE:FIL "mask_0"
:SAVE:IMAG:AREA GRAT;FACT 0;FORM NONE;INKS 0;PAL COL
:SAVE:WAV:FORM NONE
:MTES:SOUR CHAN1;ENAB 1;LOCK 1
:MTES:AMAS:SOUR CHAN1;UNIT DIV;XDEL +3.00000000E-001;YDEL +2.00000000E-001
```

```
:MTES:SCAL:BIND 0;X1 +0.0E+00;XDEL +1.0000E-09;Y1 +0.0E+00;Y2 +1.0000E+00  
:MTES:RMOD FOR;RMOD:TIME +1E+00;WAV 1000;SIGM +6.0E+00  
:MTES:RMOD:FACT:STOP 0;PRIN 0;SAVE 0  
end_setup
```

How is mask testing done?

InfiniiVision oscilloscopes start mask testing by creating a database that is 256 x 1000 for the waveform viewing area. Each location in the array is designated as either a violation or a pass area. Each time a data point from a waveform occurs in a violation area a failure is logged. Every active analog channel is tested against the mask database for each acquisition. Over 2 billion failures can be logged per-channel. The number of acquisitions tested is also logged and displayed as “# of Tests”.

The mask file allows greater resolution than the 256 X 1000 database. Some quantization of data occurs to reduce the mask file data for display on-screen.

Troubleshooting Mask Setup

If you press **Create Mask** and the mask appears to cover the entire screen, check the $\pm Y$ and $\pm X$ settings in the Automask menu. If these are set to zero the resulting mask will be extremely tight around the waveform.

If you press **Create Mask** and it appears that no mask was created, check the $\pm Y$ and $\pm X$ settings. They may be set so large that the mask is not visible.

Using Serial Decode

Agilent's hardware accelerated serial decode options can be licensed on 4-channel or 4+16-channel 6000 Series oscilloscopes. Three serial decode licenses are available:

- The N5423A (Option LSS) license provides the ability to decode I²C (Inter-IC) and SPI (Serial Peripheral Interface) serial busses.
- The N5424A (Option AMS) license provides the ability to decode CAN (Controller Area Network) and LIN (Local Interconnect Network) serial busses.
- The N5432A (Option FRS) license provides the ability to trigger on and decode FlexRay automotive serial busses. See page 164 for FlexRay triggering information.
- The N5457A (Option 232) license provides the ability to decode many UART (Universal Asynchronous Receiver/Transmitter) protocols including RS232 (Recommended Standard 232).

Adding the Automotive Serial (AMS) serial decode license will add more CAN and LIN trigger types to the trigger menu. See page 156 or page 177 for details.

To determine whether these licenses are installed on your oscilloscope press the **Utility** key, then press the **Options** softkey, the **Features** softkey, and the **Show license information** softkey.

To order serial decode licenses, contact your local Agilent Technologies representative (see www.agilent.com/find/contactus).

To decode I²C data

NOTE

Because of oscilloscope hardware resource limitations, you cannot decode I²C data while LIN triggering is selected.

NOTE

For I²C triggering setup see page 169.

To manually control Serial Decode on 6000L models start the Remote Front Panel (see page 49) and select **Waveform** from the Main Menu or press ctrl+A to access the oscilloscope's Acquire Menu.

- 1 Select the I²C serial decode mode:
 - a Press the **Acquire** key.
 - b Press the **Serial Decode** softkey.

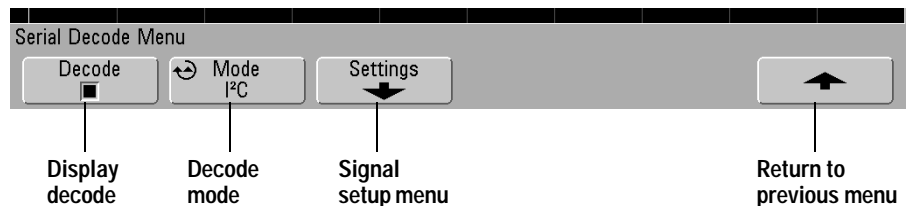

- c In the Serial Decode Menu, press the **Mode** softkey.
- d Use the Entry knob (or repeatedly press and release the **Mode** softkey) to select the **I²C** serial decode mode.

2 Specify the I²C signals:

NOTE

If you have already set up an I²C trigger, the signals have already been specified, and you can continue on with step 4.

Changing I²C signals in the Serial Decode setup also changes them in the Trigger setup.

a Press the **Settings** softkey to access the I²C Signals Menu.

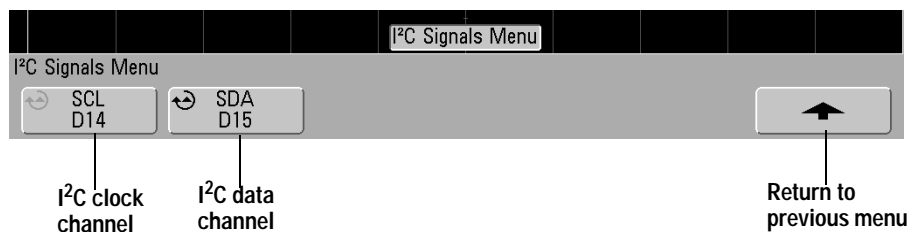

- b Press the **SCL** softkey, and use the Entry knob to select the channel probing the clock signal.
 - c Press the **SDA** softkey, and use the Entry knob to select the channel probing the data signal.
- 3 For the I²C signals, make sure the trigger or threshold levels are set to the middle of the signals:
 - For analog channels, turn the Trigger Level knob.
 - For digital channels, press the **D15 Thru D0** key and the **Thresholds** softkey to access the threshold level setting softkeys.
 - 4 If the decode line does not appear on the display, press the up-arrow softkey to return to the previous menu, then press the **Decode** softkey to turn it on.
 - 5 If the oscilloscope is stopped, press the **Run/Stop** key to acquire and decode data.

NOTE

If the setup does not produce a stable trigger, the I²C signal may be slow enough that the oscilloscope is AutoTriggering. Press the **Mode/Coupling** key, then press the **Mode** softkey to set the trigger mode from **Auto** to **Normal**.

You can use the **Zoom** horizontal sweep mode for easier navigation of the acquired data.

Interpreting Decoded I²C Data

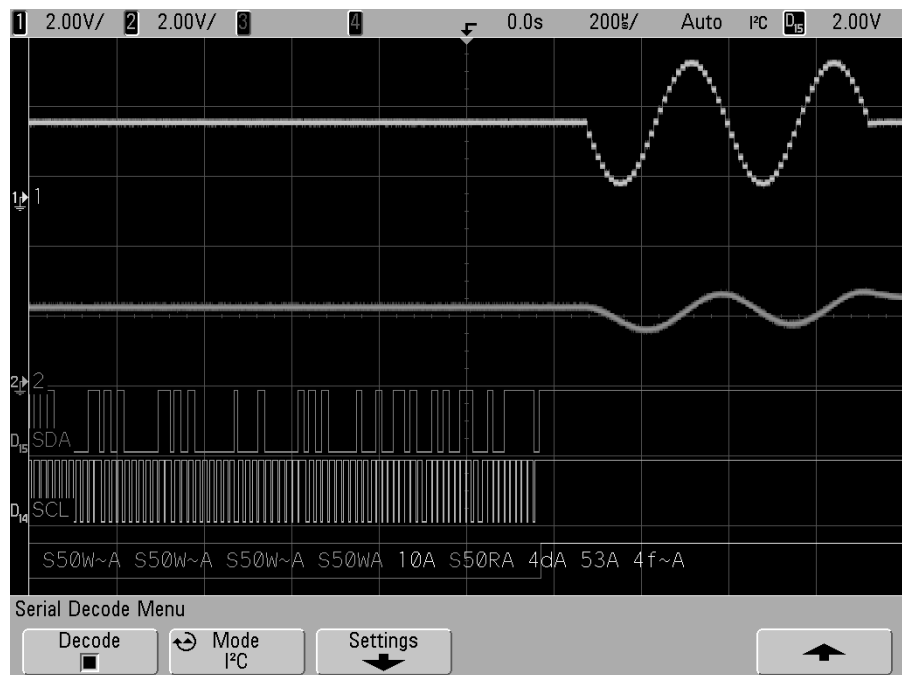

- Angled waveforms show an active bus (inside a packet/frame).
- Mid-level blue lines show an idle bus.
- In the decoded hexadecimal data:
 - Address values appear at the start of a frame.
 - Write addresses appear in light-blue along with the “W” character.
 - Read addresses appear in yellow along with the “R” character.
 - Restart addresses appear in green along with the “S” character.
 - Data values appear in white.
 - “A” indicates Ack (low), “~A” indicates No Ack (high).
 - Decoded text is truncated at the end of the associated frame when there is insufficient space within frame boundaries.
- Red dots in the decode line indicate that more data can be displayed. Scroll or expand the horizontal scale to view the data.
- Aliased bus values (undersampled or indeterminate) are drawn in red.
- Unknown bus values (undefined or error conditions) are drawn in red.

To decode SPI data

NOTE

Because of oscilloscope hardware resource limitations, you cannot decode SPI data while CAN or LIN triggering is selected.

NOTE

For SPI triggering setup see page 188.

- 1 Select the SPI serial decode mode:
 - a Press the **Acquire** key.
 - b Press the **Serial Decode** softkey.

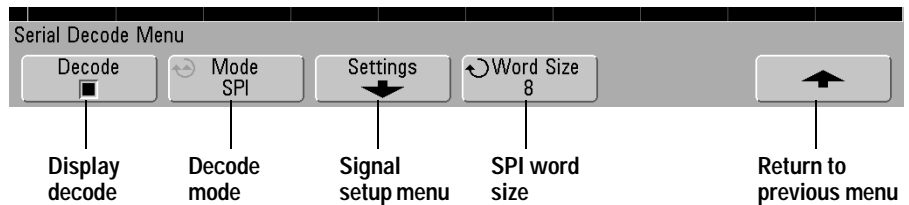

- c In the Serial Decode Menu, press the **Mode** softkey.
 - d Use the Entry knob (or repeatedly press and release the **Mode** softkey) to select the **SPI** serial decode mode.

- b Press the **Clock** softkey, and use the Entry knob to select the channel probing the clock signal.
 - c Press the rising or falling edge softkey to specify the edge that the clock occurs on.
 - d Press the **Data** softkey, and use the Entry knob to select the channel probing the data signal.
 - e Repeatedly press and release the **Frame by** softkey to select the method used to identify frames:
 - **~CS - Not Chip Select** – an active low chip select signal.
 - **CS - Chip Select** – an active high chip select signal.
 - **Clock Timeout** – clock idle for a period of time.
 - f If you chose framing by chip select or not chip select, press the **CS** or **~CS** softkey, and use the Entry knob to select the channel probing the chip select signal.

If you chose framing by clock timeout, press the **Timeout** softkey, and use the Entry knob to specify the idle time.
- 3 For the SPI signals, make sure the trigger or threshold levels are set to the middle of the signals:
 - For analog channels, turn the Trigger Level knob.
 - For digital channels, press the **D15 Thru D0** key and the **Thresholds** softkey to access the threshold level setting softkeys.
 - 4 Press the up-arrow softkey to return to the previous menu. Press the **Word Size** softkey, and use the Entry knob to select the number of bits in a word.
 - 5 If the decode line does not appear on the display, press the **Decode** softkey to turn it on.
 - 6 If the oscilloscope is stopped, press the **Run/Stop** key to acquire and decode data.

NOTE

If the setup does not produce a stable trigger, the SPI signal may be slow enough that the oscilloscope is AutoTriggering. Press the **Mode/Coupling** key, then press the **Mode** softkey to set the trigger mode from **Auto** to **Normal**.

You can use the **Zoom** horizontal sweep mode for easier navigation of the acquired data.

Interpreting Decoded SPI Data

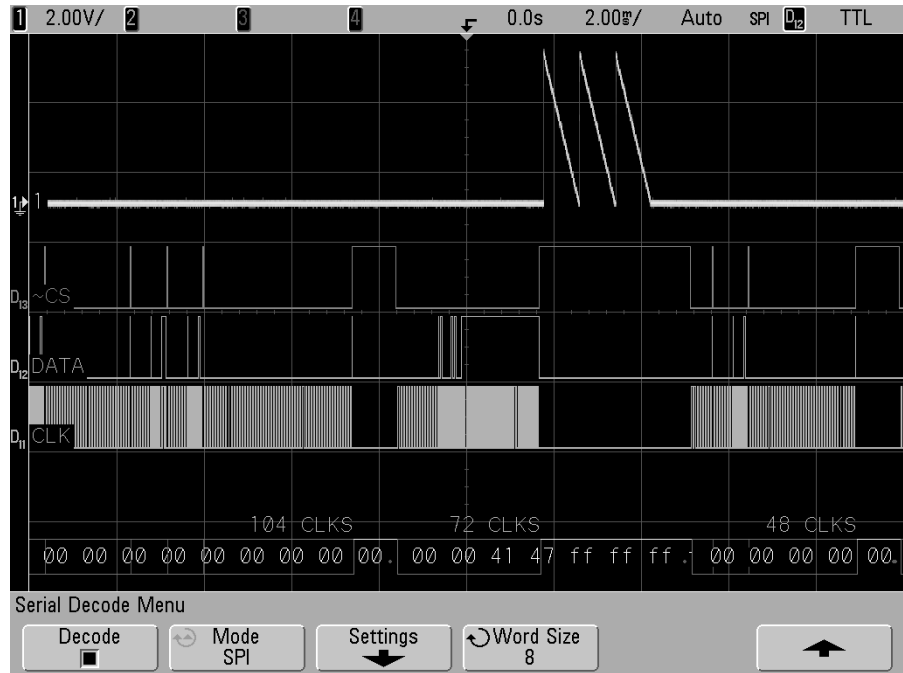

- Angled waveforms show an active bus (inside a packet/frame).
- Mid-level blue lines show an idle bus.
- The number of clocks in a frame appears in light-blue above the frame, to the right.
- Decoded hexadecimal data values appear in white.
- Decoded text is truncated at the end of the associated frame when there is insufficient space within frame boundaries.
- Red dots in the decode line indicate that there is data that is not being displayed. Scroll or expand the horizontal scale to view the information.
- Aliased bus values (undersampled or indeterminate) are drawn in red.
- Unknown bus values (undefined or error conditions) are drawn in red.

To decode CAN data

NOTE

For CAN triggering setup see page 156.

- 1 Connect the CAN signal to one of the oscilloscope's input channels.
- 2 Set up the trigger mode as described in “Triggering the Oscilloscope” on page 135. You can use CAN trigger or another trigger type.
- 3 Select the CAN serial decode mode:
 - a Press the **Acquire** key.
 - b Press the **Serial Decode** softkey.

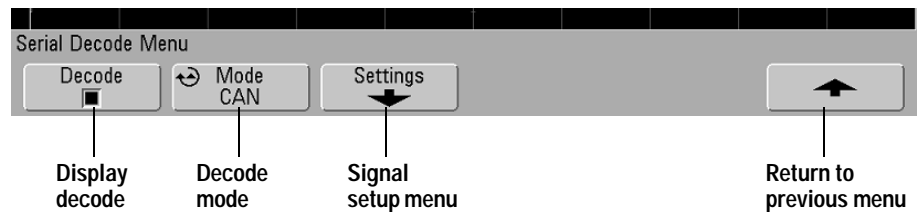

- c In the Serial Decode Menu, press the **Mode** softkey.
- d Use the Entry knob (or repeatedly press and release the **Mode** softkey) to select the **CAN** serial decode mode.

4 Specify the CAN signal:

- a Press the **Settings** softkey to access the CAN Signals Menu.

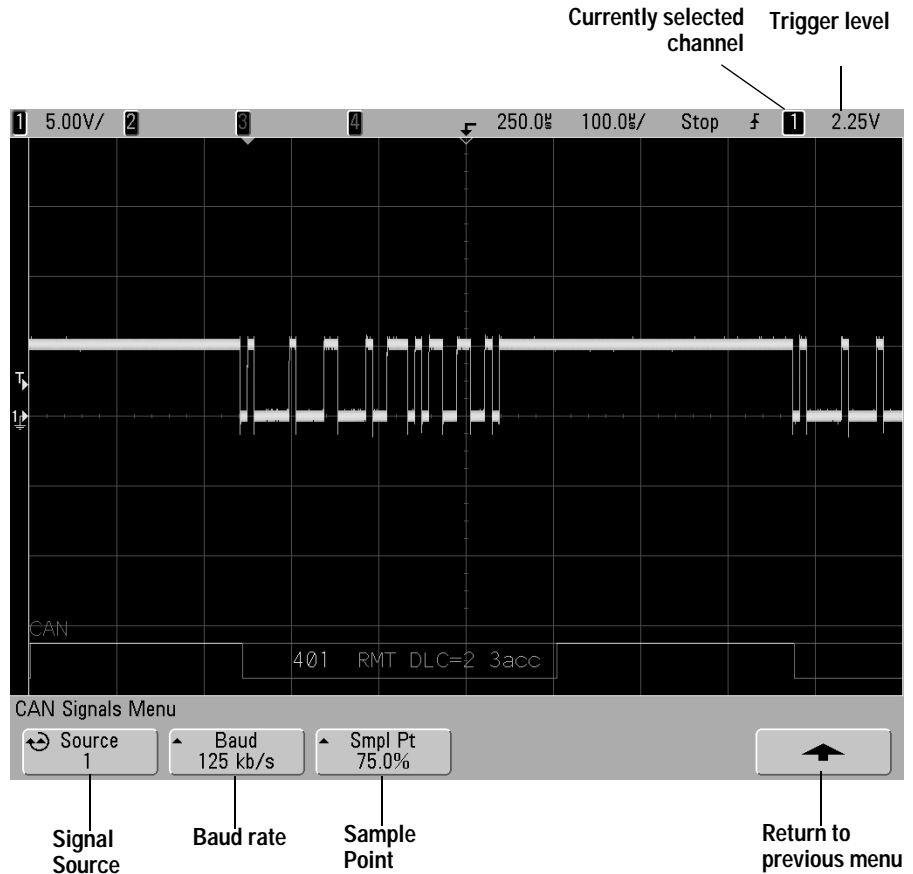

- 5 Press the **Source** softkey, and use the Entry knob to select the channel for the CAN signal. Make sure the trigger or threshold levels are set to the middle of the CAN signal.
- 6 Repeatedly press and release the **Baud** softkey to set the CAN signal baud rate to match your CAN bus signal.

The CAN baud rate can be set to:

10 kb/s	50 kb/s	100 kb/s	500 kb/s
20 kb/s	62.5 kb/s	125 kb/s	800 kb/s
33.3 kb/s	83.3 kb/s	250 kb/s	1 Mb/s
User Defined			

The default baud rate is 1 Mb/s

If the desired baud rate is not shown in the table, select User Defined. You can set the CAN baud rate from 10.0 kb/s to 1.000 Mb/s in increments of 100 b/s. Press the **User Baud** softkey and rotate the Entry knob to make your selection.

- 7 Repeatedly press and release the **Smpl Pt** softkey to select the point between phase segments 1 and 2 where the state of the bus is measured. This controls the point within the bit's time where the bit value is captured.

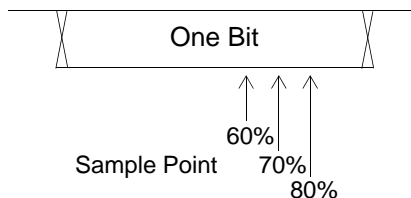

- 8 Set the trigger level.
 - For analog channels, turn the Trigger Level knob.
 - For digital channels, press the **D15 Thru D0** key and the **Thresholds** softkey to access the threshold level setting softkeys.

NOTE

Changing the Source settings in the Serial Decode setup also changes them in the Trigger setup.

- 9 Return to the previous menu by pressing the up-arrow softkey.
- 10 If the decode line does not appear on the display, press the **Decode** softkey to turn it on.

11 If the oscilloscope is stopped, press the **Run/Stop** key to acquire and decode data.

NOTE

If the setup does not produce a stable trigger, the CAN signal may be slow enough that the oscilloscope is AutoTriggering. Press the **Mode/Coupling** key, then press the **Mode** softkey to set the trigger mode from **Auto** to **Normal**.

You can use the **Zoom** horizontal sweep mode for easier navigation of the decoded data.

Interpreting Decoded CAN Data

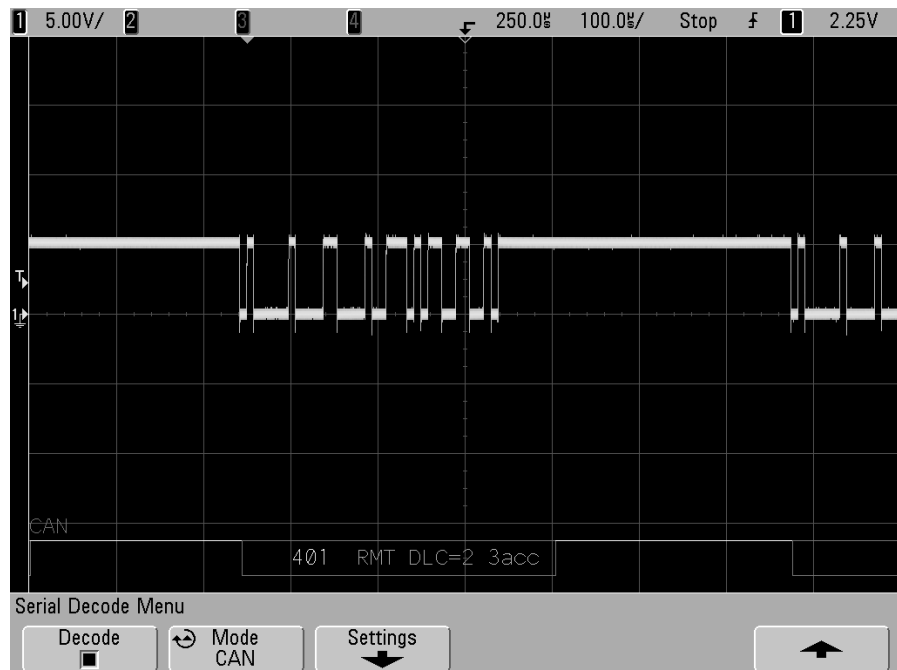

- Frame ID appears in hex digits in yellow. Frames of 11 or 29 bits are automatically detected.
- Remote frame (RMT) appears in green.

- Data length code (DLC) appears in blue for data frames and green for remote frames.
- Data bytes appear in hex digits in white for data frames.
- Cyclic redundancy check (CRC) appears in hex digits in blue when valid, or in red to indicate that the oscilloscope's hardware decode calculated a CRC that is different from the incoming CRC data stream.
- Angled waveforms show an active bus (inside a packet/frame).
- Mid-level blue lines show an idle bus.
- Decoded text is truncated at the end of the associated frame when there is insufficient space within frame boundaries.
- Red dots in the decode line indicate that there is data that is not being displayed. Scroll or expand the horizontal scale to view the information.
- Aliased bus values (undersampled or indeterminate) are drawn in red.
- Unknown bus values (undefined or error conditions) are drawn in red with a “?” label.
- Flagged error frames are drawn in red with an “ERR” label.

6 Displaying Data

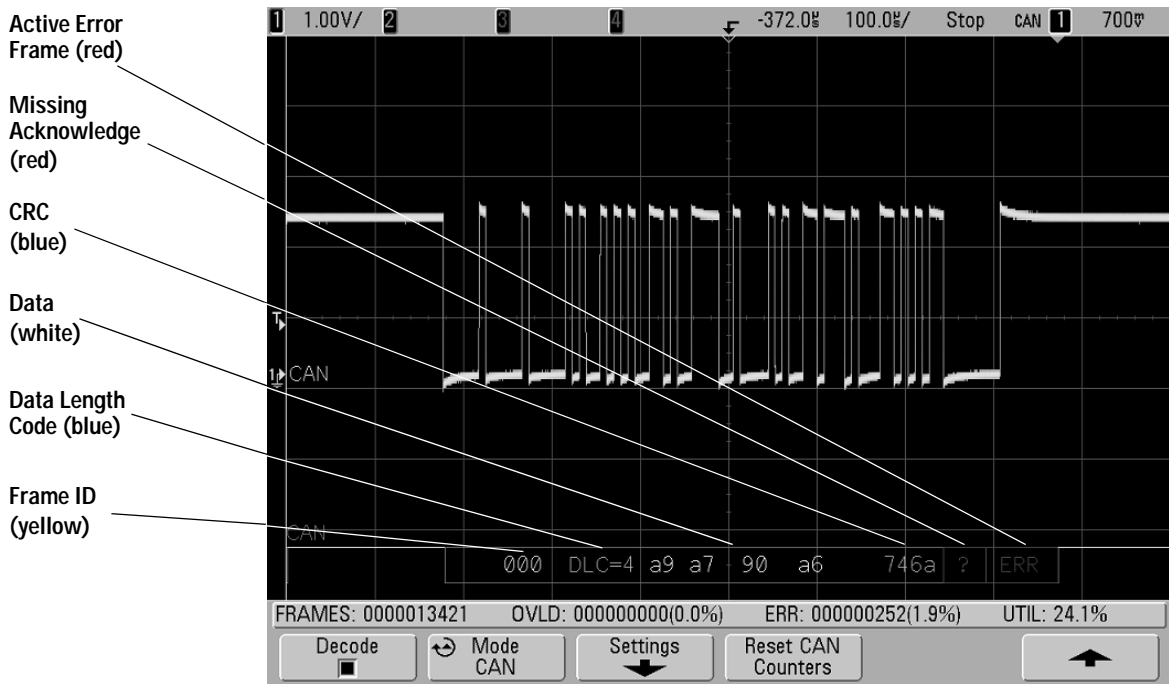

CAN Totalizer

The CAN totalizer provides a direct measure of bus quality and efficiency. The CAN totalizer measures total CAN frames, flagged error frames, overload frames, and bus utilization.

The totalizer is always running (counting frames and calculating percentages) and is displayed whenever CAN decode is displayed. The totalizer counts even when the oscilloscope is stopped (not acquiring data). Pressing the **Run/Stop** key does not affect the totalizer. When an overflow condition occurs, the counter displays **OVERFLOW**. The counters can be reset to zero by pressing the **Reset CAN Counters** softkey.

Types of Frames

- *Active error frames* are CAN frames in which a CAN node recognizes an error condition during a data or remote frame and issues an active error flag.
- A *partial frame* occurs when the oscilloscope detects any error condition during a frame that is not followed by an active error flag. Partial frames are not counted.

Counters

- The **FRAMES** counter gives the total number of completed remote, data, overload, and active error frames.
- The **OVL** counter gives the total number of completed overload frames and their percentage of the total number of frames.
- The **ERR** counter gives the total number of completed active error frames and their percentage of the total number of frames.
- The **UTIL** (bus load) indicator measures the percentage of time the bus is active. The calculation is done on 330 ms periods, approximately every 400 ms.

Example: If a data frame contains an active error flag, both the **FRAMES** counter and the **ERR** counter will be incremented. If a data frame contains an error that is not an active error it is considered a partial frame and no counters are incremented.

6 Displaying Data

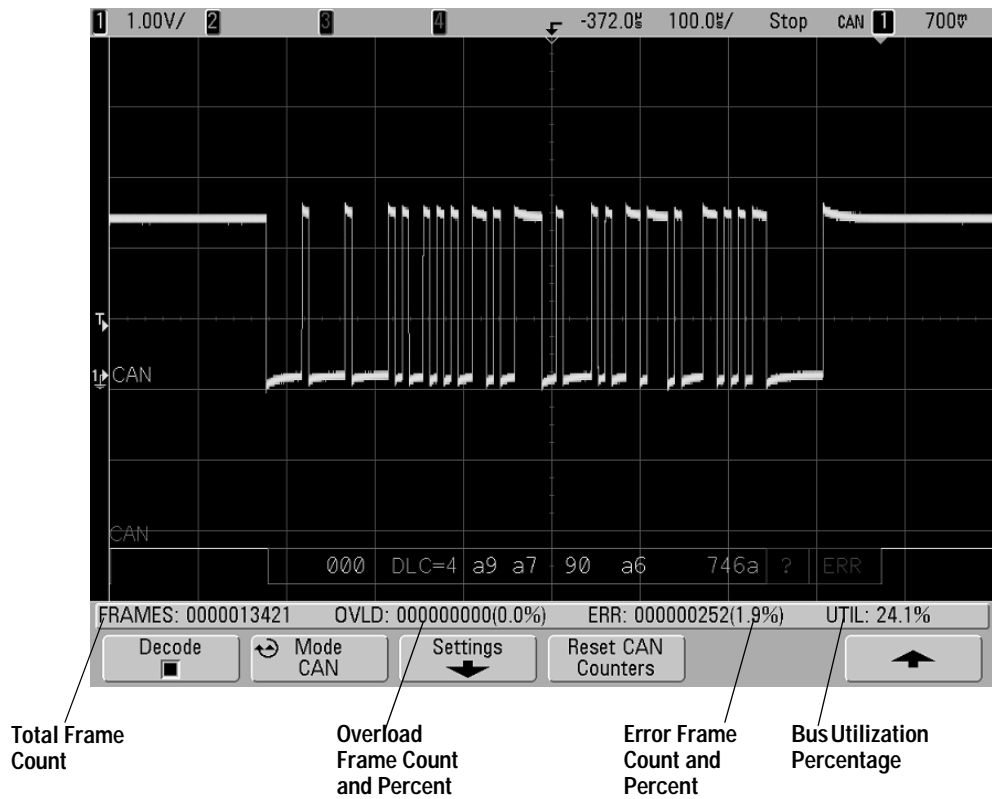

To decode LIN data

NOTE

For LIN triggering setup see page 177.

- 1 Select the LIN serial decode mode:
 - a Press the **Acquire** key.
 - b Press the **Serial Decode** softkey.

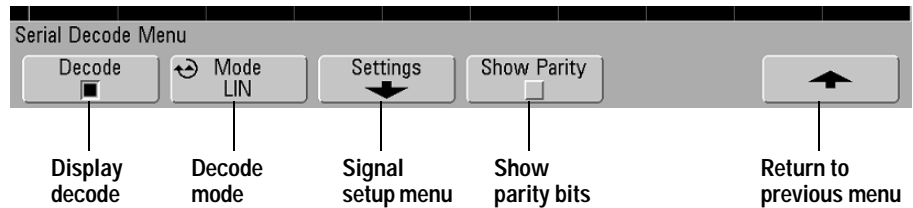

- c In the Serial Decode Menu, press the **Mode** softkey.
 - d Use the Entry knob (or repeatedly press and release the **Mode** softkey) to select the **LIN** serial decode mode.
- 2 Choose whether to include the parity bits in the identifier field.
 - a If you want to mask the upper two parity bits, ensure that the box under the **Show Parity** softkey is not selected.
 - b If you want to include the parity bits in the identifier field, ensure that the box under the **Show Parity** softkey is selected.

3 Specify the LIN signal:

- a Press the **Settings** softkey to access the LIN Signals Menu.

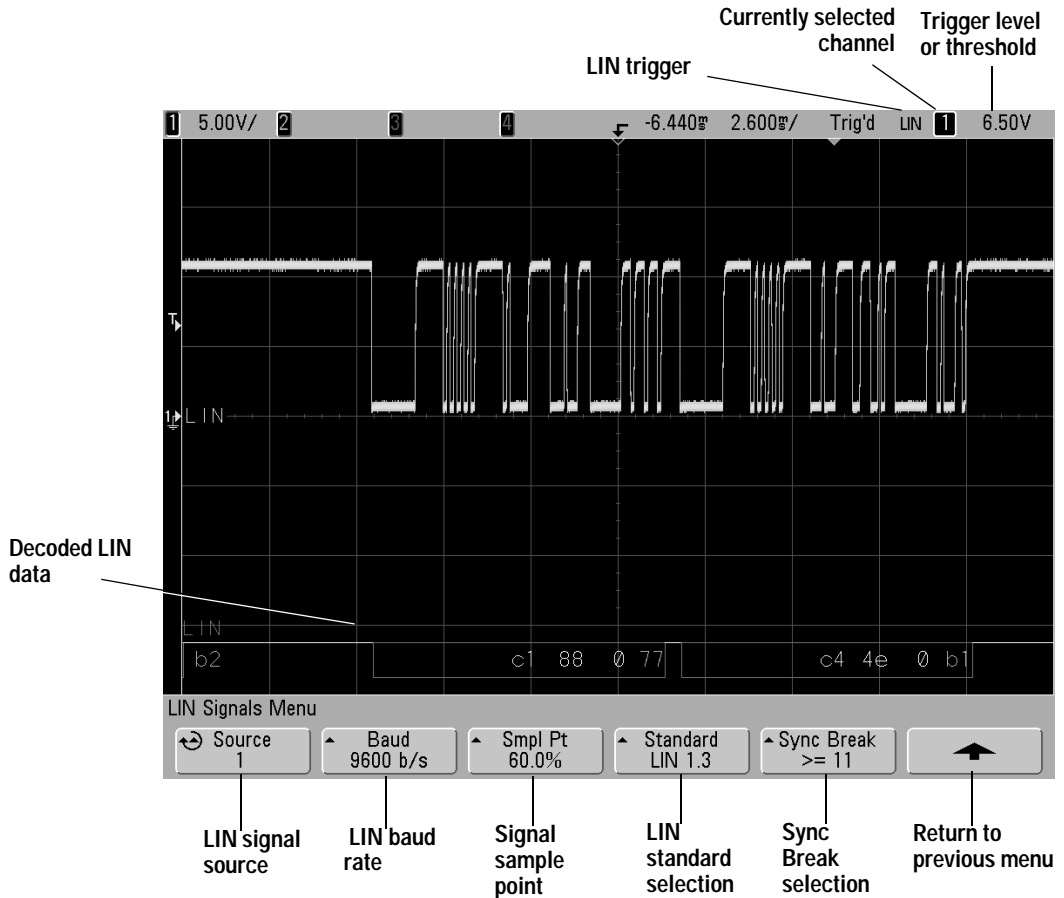

- b Press the **Source** softkey, and use the Entry knob to select the channel probing the LIN signal.
- c Press the **Baud** softkey and rotate the Entry knob to set the LIN signal baud rate to match your LIN bus signal.

The LIN baud rate can be set to 2400 b/s, 9600 b/s, 10.4 kb/s, 19.2 kb/s, 115.2 kb/s, 625 kb/s, or User Defined. The default baud rate is 2400 b/s.

If the desired baud rate is not shown in the list, select **User Defined**. You can set the LIN baud rate from 2.4 kb/s to 625 kb/s in increments of 100 b/s. Press the **User Baud** softkey and rotate the Entry knob to make your selection.

- d Repeatedly press and release the **Smpl Pt** softkey to select the sample point. This controls the point within the bit's time where the bit value is captured.

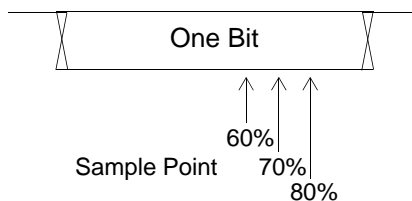

- e Repeatedly press and release the **Standard** softkey to select the LIN standard (LIN 1.3 or LIN 2.0) of the measured signal. For LIN 1.2 signals, use the LIN 1.3 setting. The LIN 1.3 setting assumes the signal follows the “Table of Valid ID Values” as shown in section A.2 of the LIN Specification dated December 12, 2002. If your signal does not comply with the table, use the LIN 2.0 setting.
- f Repeatedly press and release the **Sync Break** softkey to define the minimum number of clocks that define a Sync Break.
- 4 Make sure the trigger or threshold levels are set to the middle of the LIN signal.
- For analog channels, turn the Trigger Level knob.
 - For digital channels, press the **D15 Thru D0** key and the **Thresholds** softkey to access the threshold level setting softkeys.

NOTE

Changing the Trigger settings in the Serial Decode setup also changes them in the Trigger setup.

- g If the decode line does not appear on the display, press the up-arrow softkey to return to the previous menu, then press the **Decode** softkey.

- 5 If the oscilloscope is stopped, press the **Run/Stop** key to acquire and decode data.

NOTE

If the setup does not produce a stable trigger, the LIN signal may be slow enough that the oscilloscope is AutoTriggering. Press the **Mode/Coupling** key, then press the **Mode** softkey to set the trigger mode from **Auto** to **Normal**.

You can use the **Zoom** horizontal sweep mode for easier navigation of the decoded data.

Interpreting Decoded LIN Data

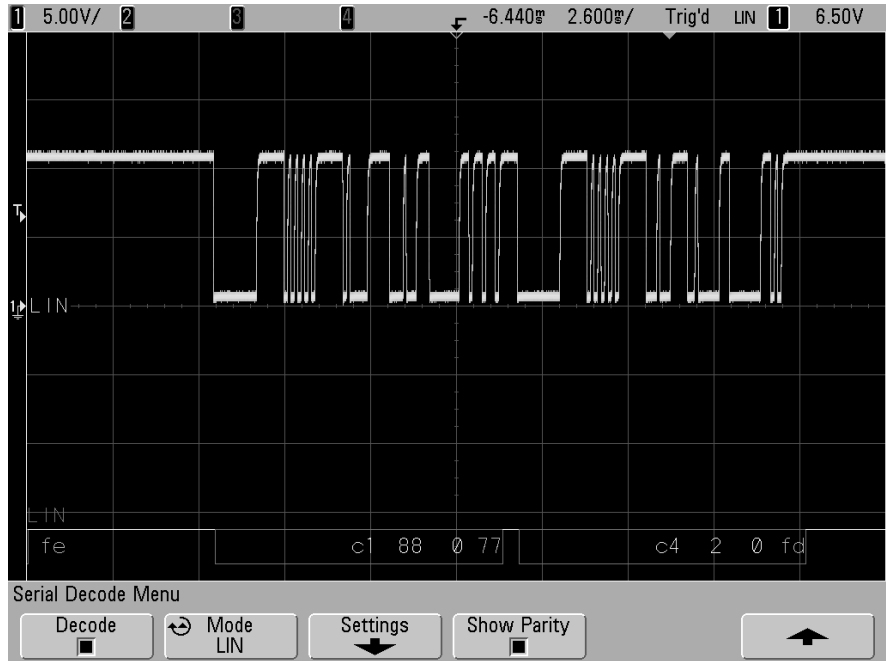

- Angled waveforms show an active bus (inside a packet/frame).
- Mid-level blue lines show an idle bus (LIN 1.3 only).
- The hexadecimal ID and parity bits (if enabled) appear in yellow. If a parity error is detected the hexadecimal ID and parity bits (if enabled) appear in red.
- Decoded hexadecimal data values appear in white.
- For LIN 1.3, the checksum appears in blue if correct, or red if incorrect. The checksum always appears in white for LIN 2.0.
- Decoded text is truncated at the end of the associated frame when there is insufficient space within frame boundaries.
- Red dots in the decode line indicate that there is data that is not being displayed. Scroll or expand the horizontal scale to view the information.
- Unknown bus values (undefined or error conditions) are drawn in red.
- If there is an error in the synch field, SYNC will appear in red.
- If the header exceeds the length specified in the standard, THM will appear red.
- If the total frame count exceeds the length specified in the standard, TFM will appear red (LIN 1.3 only).
- For LIN 1.3 a wakeup signal is indicated by WAKE in blue. If the wakeup signal is not followed by a valid wakeup delimiter a wakeup error is detected and displayed as WUP in red.

To decode FlexRay

To decode FlexRay data, you need a four-channel 7000 Series mixed signal oscilloscope, the Option FRS (N5432B) FlexRay triggering and decode option, which includes the Agilent VPT1000 protocol analyzer module, and cables. The Option FRS allows you to:

- Control the VPT1000 (without a PC).
- Trigger on FlexRay bus frames, synchronous timing slots/segments, or error conditions.
- Display decoded FlexRay bus data and synchronous timing.

Modes of VPT1000 Control/Operation

The oscilloscope and VPT1000 can be used in one of three ways:

- Oscilloscope controls the VPT1000, asynchronous mode monitoring (LAN connection required).
- Oscilloscope controls the VPT1000, synchronous mode monitoring (LAN connection required).
- PC controls the VPT1000. (Requires appropriate FlexRay protocol analysis software.)

When the oscilloscope controls the VPT1000, the system is a standalone, time-correlated measurement system (no external PC required).

Oscilloscope Controls the VPT1000, Asynchronous Mode Monitoring

Asynchronous analysis provides decoding of FlexRay frames based on user-selected channel and baud rate. These can be set in the oscilloscope's VPT1000 menu.

Oscilloscope Controls the VPT1000, Synchronous Mode Monitoring

In addition to decoding FlexRay frames (which is also available in Asynchronous mode), the synchronous mode also provides a time-correlated display of segment and slot timing boundaries. This requires importing a FIBEX (Field Bus Exchange format) file that defines the synchronous global FlexRay schedule.

PC Controls the VPT1000

For more advanced FlexRay protocol analysis, the VPT1000 can be controlled by a PC and configured for either synchronous or asynchronous operation using appropriate FlexRay protocol analysis software.

This type of system configuration provides higher-level FlexRay protocol analysis measurements on the PC and time-correlated FlexRay measurements on the oscilloscope's display.

Setting Up the Oscilloscope and the VPT1000

Connecting the Oscilloscope and the VPT1000

- 1 The oscilloscope power should already be on.
- 2 Connect power to the VPT1000. In about 10 seconds, the State LED will illuminate green.
- 3 Connect the MSO communication cable (that has the ODU connector on one end; supplied with Option FRS) between the VPT1000 and the oscilloscope's digital input connector on the oscilloscope's rear panel. The ODU end of this cable connects to the large, unlabeled connector on the VPT1000. (All of the VPT1000's connectors are ODU-type connectors.)
- 4 If the oscilloscope will control the VPT1000, the oscilloscope and the VPT1000 must be connected using the special LAN cable provided with the VPT1000. If the VPT1000 will be controlled by a PC, connect this cable to the PC.
- 5 Connect the FlexRay input cable from the VPT1000 FlexRay1 port or FlexRay2 port to the target system differential bus.

This cable has an ODU-type connector on one end and a DB-9 (DE-9) connector on the other.

- 6 Connect a differential probe (for example Agilent InfiniiMax 1130A Series probe) to one of the oscilloscope analog channels and to the FlexRay differential bus.

Setting up VPT1000/oscilloscope LAN communication

This is necessary when the oscilloscope controls the VPT1000 in either Asynchronous or Synchronous mode, but not when a PC with appropriate FlexRay protocol analysis software controls the VPT1000.

Note that the VPT1000 is shipped pre-configured with an IP address of 192.168.80.80, and a subnet mask of 255.255.240.0. These instructions assume the VPT1000 address has not been changed. To change the VPT1000's IP address, see page 398.

Set the oscilloscope's IP address

- 1 Press **Utility&IO&Control**. Deselect the LAN check box (turn it off) if not already deselected.
- 2 Press the **LAN Settings** softkey.
- 3 Press the **Config** softkey. Deselect **DHCP** and **AutoIP**.
- 4 Press the **Address** softkey. Press the **Modify** softkey. Set the oscilloscope's IP address to 192.168.80.1. (The first three dot-separated numbers in the oscilloscope's IP address must match the first three numbers in the VPT1000's IP address. The last dot-separated number in the IP address must be different from the VPT1000's). Press the **Apply** softkey.
- 5 Press the **Modify** softkey twice. Set the oscilloscope's Subnet mask to 255.255.240.0. Press the **Apply** softkey.
- 6 Press the **Modify** softkey twice. Set the oscilloscope's Gateway IP to 192.168.80.1. Press the **Apply** softkey.

Set the oscilloscope to communicate with the VPT1000

- 7 In the Waveform section on the front panel, press the **Acquire** key.

- 8 Press the **Serial Decode** softkey, and use the Entry knob to select **FlexRay**.
- 9 Press the **Decode** softkey to enable decode.
- 10 Press the **Settings** softkey to access the VPT1000 Menu.
- 11 Press the **Mode** softkey and select Asynchronous.
- 12 Press the **Baud** and **Channel** softkeys and set the parameters to match your target system. Note that FlexRay Channel A setting on the oscilloscope is associated with the FlexRay1 input of the VPT1000. FlexRay Channel B is associated with FlexRay2.

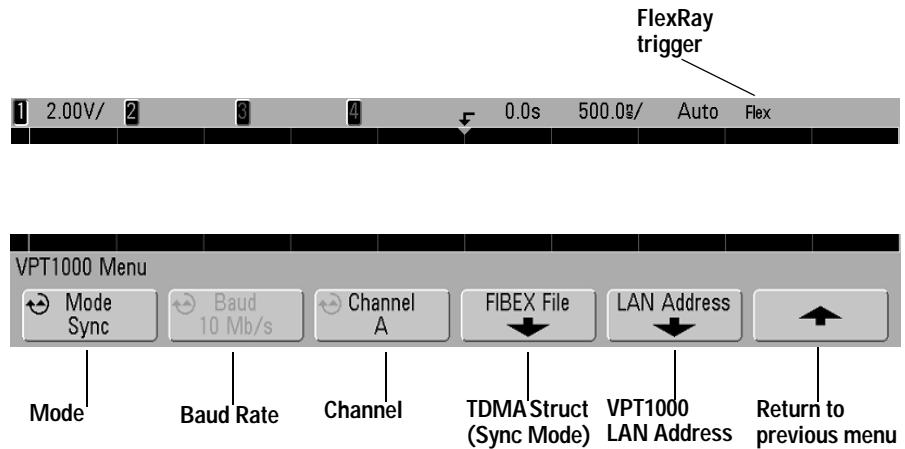

- 13 From the VPT1000 Menu, press the **LAN Address** softkey to access the VPT1000 LAN Addresses Menu.
- 14 Enter the VPT1000's 4-byte IP address:
 - a Press the **Value** softkey and use the Entry knob to select a byte value.
 - b Press the **Next** softkey to access the next byte.
- 15 When you have finished entering the IP address, press the **Apply** softkey.

The oscilloscope will begin showing asynchronous FlexRay decode if valid FlexRay traffic is on the bus.

Selecting Asynchronous, Synchronous, or PC mode

First, access the VPT1000 menu.

- 1 In the Waveform section on the front panel, press the **Acquire** key.
- 2 Press the **Serial Decode** softkey, and use the Entry knob to select **FlexRay**.
- 3 Press the **Decode** softkey to enable decode.
- 4 Press the **Settings** softkey to access the VPT1000 Menu.

NOTE

Changing the VPT1000 settings in the Serial Decode Menu also changes them in the FlexRay Trigger Menu.

- 5 Press the **Mode** softkey to select one of these operating modes:
 - **PC** – PC controls the VPT1000.
 - **Asynchronous** – oscilloscope controls the VPT1000 for frame decode information only.
 - **Synchronous** – oscilloscope controls the VPT1000 for frame decode along with synchronous slot/segment timing boundaries.

In PC Mode The VPT1000 must be connected to the PC via LAN. The PC must have the appropriate FlexRay protocol analysis software.

In Asynchronous Mode

This presumes you have established LAN communication as described in “Setting up VPT1000/oscilloscope LAN communication” on page 327.

- 1 Press the **Baud** softkey to select a baud rate of **2.5 Mb/s**, **5 Mb/s**, or **10 Mb/s** to match your target system.
- 2 Press the **Channel** softkey to select channel **A** or **B**.

In Synchronous Mode

This presumes you have established LAN communication as described in “Setting up VPT1000/oscilloscope LAN communication” on page 327.

To use synchronous mode, you must load a FIBEX file (.xml) which defines the global scheduling parameters of your target system.

- 1 Ensure the synchronous mode of operation is selected.
- 2 Copy the FIBEX file to a USB storage device.
- 3 Connect the USB storage device to the oscilloscope.
- 4 Press the **FIBEX File** softkey. Navigate to the FIBEX file and load it.

The oscilloscope stores the pertinent synchronous timing parameters in non-volatile memory. If your schedule changes you will need to re-load the new FIBEX file.

- 5 Press the **Channel** softkey to select channel **A** or **B**.

NOTE

If the VPT1000 loses synchronization, then press the **Mode** key (in the VPT1000 Menu) on the oscilloscope to cycle through the modes and restore synchronization.

NOTE

Before powering-off the oscilloscope, it is recommended that you change the VPT1000 mode to **PC**.

If oscilloscope is shut off while in Asynchronous or Synchronous modes, communication with the VPT1000 will not be automatically restored up on power up. To restore communication with the VPT1000, cycle the VPT1000 power, wait for its State indicator to turn from red to green, and then press the **Mode** key (in the VPT1000 Menu) on the oscilloscope to cycle through the modes.

To display decoded FlexRay data

- 1 Set up communication between the oscilloscope and the VPT1000. See “Setting Up the Oscilloscope and the VPT1000” on page 326.
- 2 For FlexRay triggering set up, see “Triggering on FlexRay Frames, Times, or Errors” on page 164.

While decoding FlexRay data, you can use FlexRay trigger or another trigger type, such as duration, I²C, Nth edge burst, sequence, SPI, or USB. When the oscilloscope is in FlexRay trigger mode, only FlexRay decode is available.

- 3 Select the FlexRay serial decode mode:
 - a Press the **Acquire** key.
 - b Press the **Serial Decode** softkey.

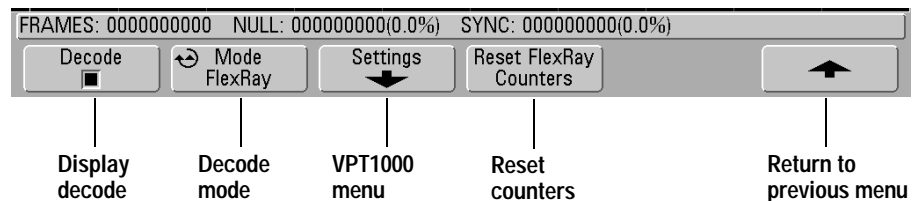

- c In the Serial Decode Menu, press the **Mode** softkey.
 - d Use the Entry knob (or repeatedly press and release the **Mode** softkey) to select the **FlexRay** serial decode mode.
- 4 Ensure **Decode** is switched on. The VPT1000 must be connected and running in asynchronous or synchronous mode for a meaningful display.
- 5 If the oscilloscope is stopped, press the **Run/Stop** key to acquire and decode data.
- 6 If decoded data does not appear, press the **Settings** softkey, then repeatedly press the **Mode** softkey (in the VPT1000 Menu) to cycle through the modes and establish synchronization.

You can use the **Zoom** horizontal sweep mode for easier navigation of the decoded data.

Interpreting Decoded FlexRay Frame Data

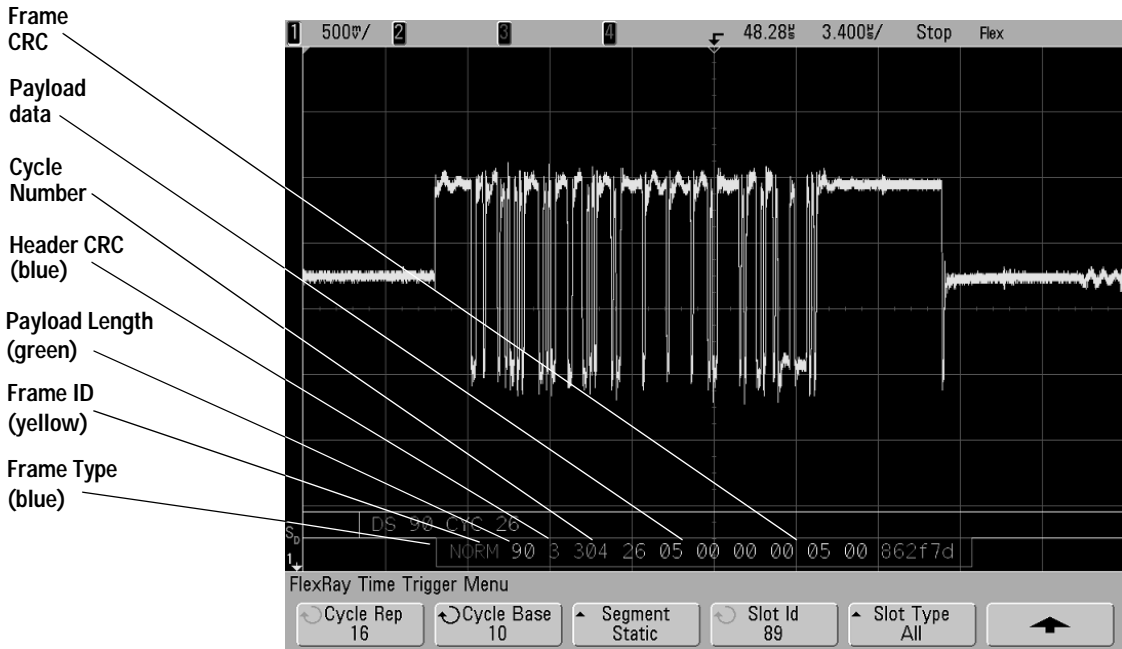

The FlexRay decode display shows frame decoding (bottom row) and if the VPT1000 is in the synchronous monitoring mode, global time-schedule decoding (top row).

Frame Decoding (bottom row of decode display)

- Frame type (NORM, SYNC, SUP, NULL in blue).
- Frame ID (decimal digits in yellow).
- Payload-length (decimal number of words in green).
- Header CRC (hex digits in blue plus red HCRC error message if invalid).
- Cycle number (decimal digits in yellow).
- Data bytes (HEX digits in white).
- Frame CRC (hex digits in blue plus red FCRC error message if invalid).
- Frame/coding errors (specific error symbol in red).

Interpreting Decoded FlexRay Time Data

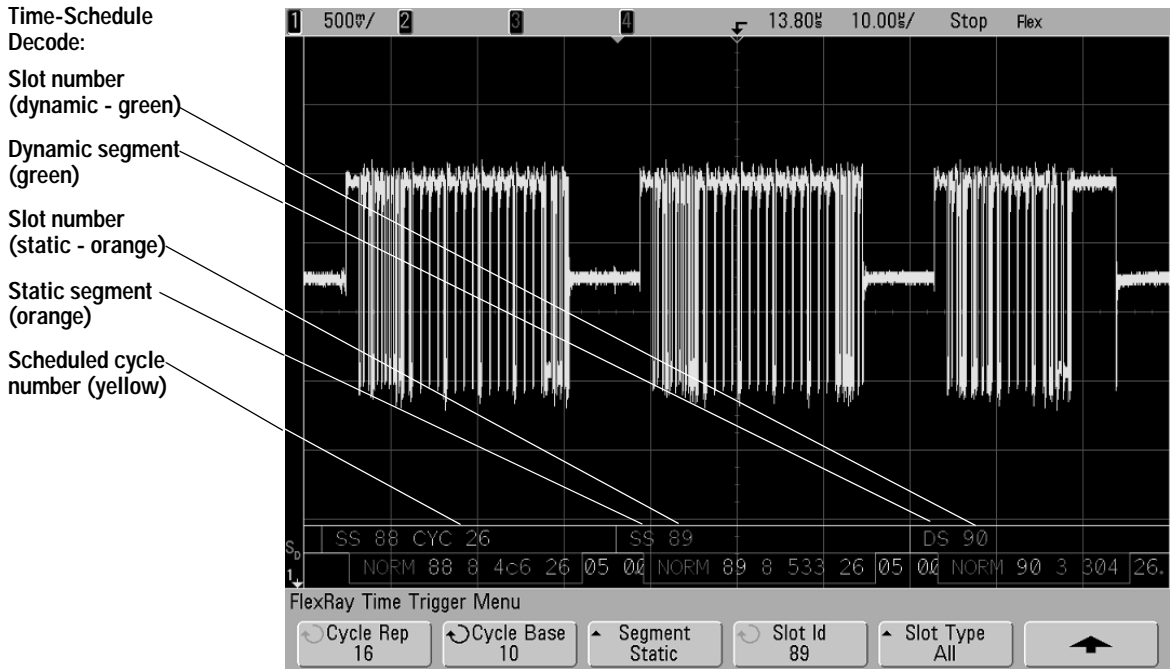

Global Time-Schedule Decoding (top row of decode display)

- Segment type: static = SS in orange, dynamic = DS in green, Symbol in yellow, Idle = NIT (network idle time) in white.
- Slot number: decimal digits in orange (static) or green (dynamic).
- Cycle number (CYC + decimal digits in yellow).
- Timing errors (specific error symbol in red).

FlexRay Totalizer

The FlexRay totalizer consists of counters that provide a direct measure of bus quality and efficiency. The totalizer appears on screen whenever FlexRay Decode is ON in the Serial Decode Menu.

The totalizer is running, counting frames and calculating percentages, even when the oscilloscope is stopped (not acquiring data).

When an overflow condition occurs, the counter displays **OVERFLOW**.

The counters can be reset to zero by pressing the **Reset FlexRay Counters** softkey.

Counters

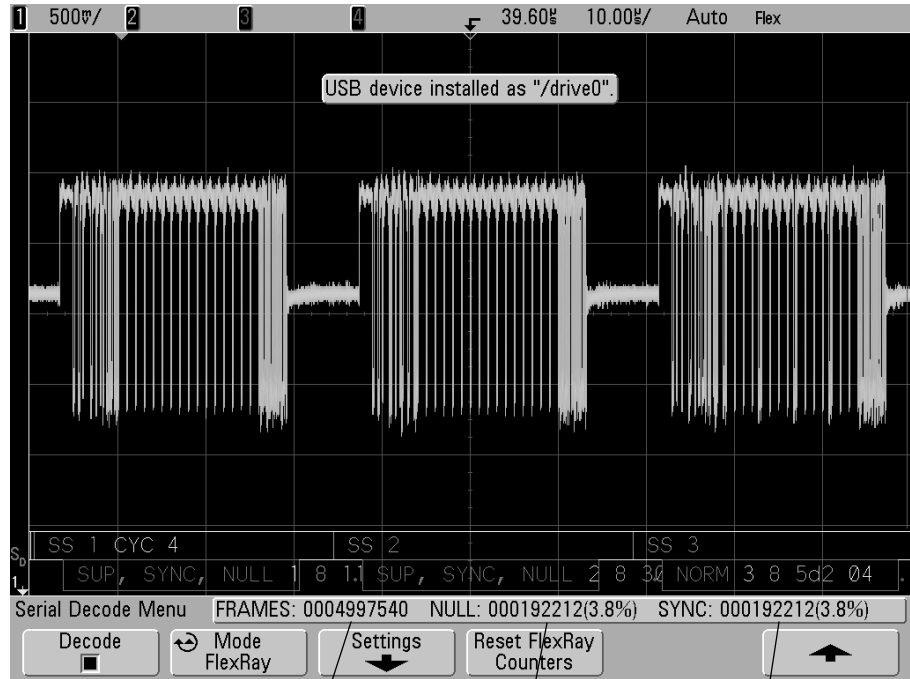

Total Frame Count

Null Frame Count and Percent

Sync Frame Count and Percent

- The FRAMES counter gives a real-time count of all frames received by the VPT1000.
- The NULL counter gives the number and percentage of null frames.
- The SYNC counter gives the number and percentage of sync frames.

To decode UART/RS232 data

NOTE

Because of oscilloscope hardware resource limitations, you cannot decode UART/RS232 data while CAN, LIN, or FlexRay triggering is selected.

NOTE

For UART/RS232 triggering setup see page 205.

1 Select the UART/RS232 serial decode mode:

- a Press the **Acquire** key.
- b Press the **Serial Decode** softkey.

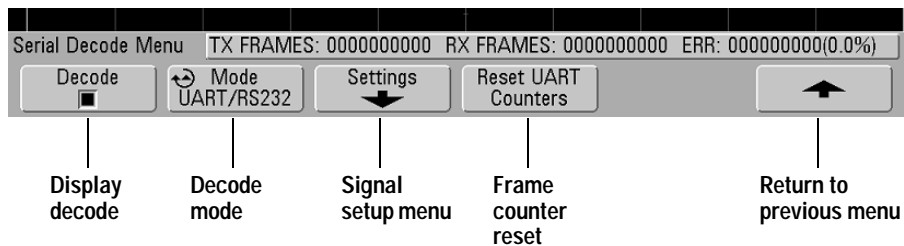

- c In the Serial Decode Menu, press the **Mode** softkey.
- d Use the Entry knob (or repeatedly press and release the **Mode** softkey) to select the **UART/RS232** serial decode mode if it is not already selected.

NOTE

Changing UART/RS232 signals in the Serial Decode setup also changes them in the Trigger setup.

- 2 Specify the UART/RS232 signals:
 - a Press the **Settings** softkey to access the UART/RS232 decode settings menu.

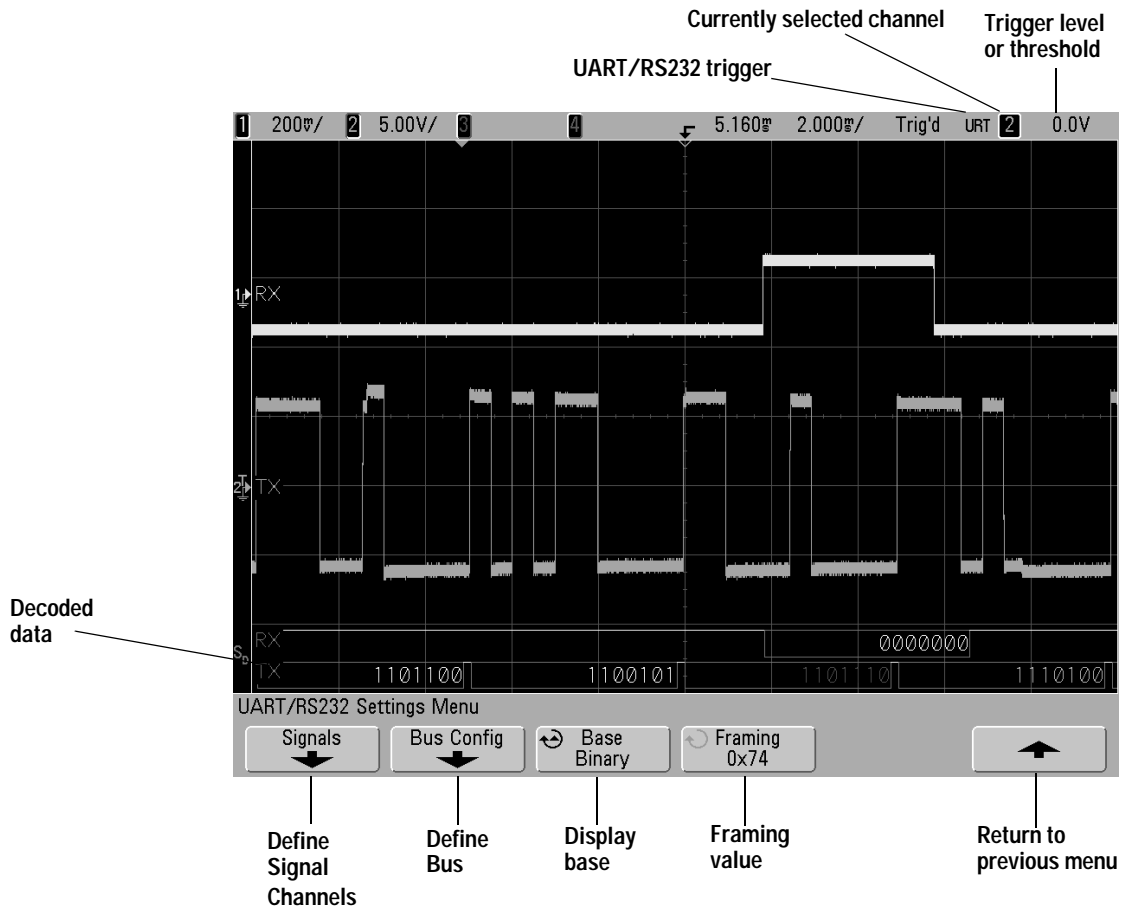

- b Press the **Signals** softkey, and select the oscilloscope channels that you have connected to the Rx and Tx signals.

See the UART/RS232 triggering section on page page 205 for detailed instructions.

3 Press the Return to previous menu (up arrow) softkey.

NOTE

Changing the Bus Configuration settings in the Serial Decode setup also changes them in the Trigger setup.

4 Press the **Bus Config** softkey.

- a **#Bits:** Set the number of bits in the UART/RS232 words to match your target system (selectable from 5-9 bits).
- b **Parity:** Choose odd, even, or none, based on your target system.
- c **Baud:** Select the baud rate to match the signal in your target system.
- d **Polarity:** Select idle low or idle high to match your target system's state when at idle. For RS232 select idle low.
- e **Bit Order:** Select whether the most significant bit (MSB) or the least significant bit (LSB) is presented after the start bit in the signal from your target system. For RS232 select LSB.

NOTE

In the decode display the most significant bit is always displayed on the left regardless of how Bit Order is set.

5 Press the Return to previous menu (up arrow) softkey.

6 Press the **Base** softkey to select the base (hex, binary, or ASCII) in which decoded words are displayed.

- When displaying words in ASCII, the 7-bit ASCII format is used. Valid ASCII characters are between 0x00 and 0x7F. To display in ASCII you must select at least 7 bits in the Bus Configuration. If ASCII is selected and the data exceeds 0x7F, the data is displayed in hex.
- When **#Bits** is set to 9, the 9th (alert) bit is displayed directly to the left of the ASCII value (which is derived from the lower 8 bits).

- 7 Optional: Press the **Framing** softkey and select a value. In the decode display the chosen value will be displayed in light blue. However, if a parity error occurs the data will be displayed in red.
- 8 Make sure the trigger or threshold levels are set to the middle of the signals:
 - For analog channels, turn the Trigger Level knob.
 - For digital channels, press the **D15-D0** key and the **Thresholds** softkey to access the threshold level setting softkeys.
- 9 If the decode line does not appear on the display, press the up arrow key to return to the previous menu, then press the **Decode** softkey to turn on serial decode.
- 10 If the oscilloscope is stopped, press the **Run/Stop** key to acquire and decode data.

NOTE

If the setup does not produce a stable trigger, the UART/RS232 signal may be slow enough that the oscilloscope is AutoTriggering. Press the **Mode/Coupling** key, then press the **Mode** softkey to set the trigger mode from **Auto** to **Normal**.

You can use the **Zoom** horizontal sweep mode for easier navigation of the acquired data.

Interpreting Decoded UART/RS232 Data

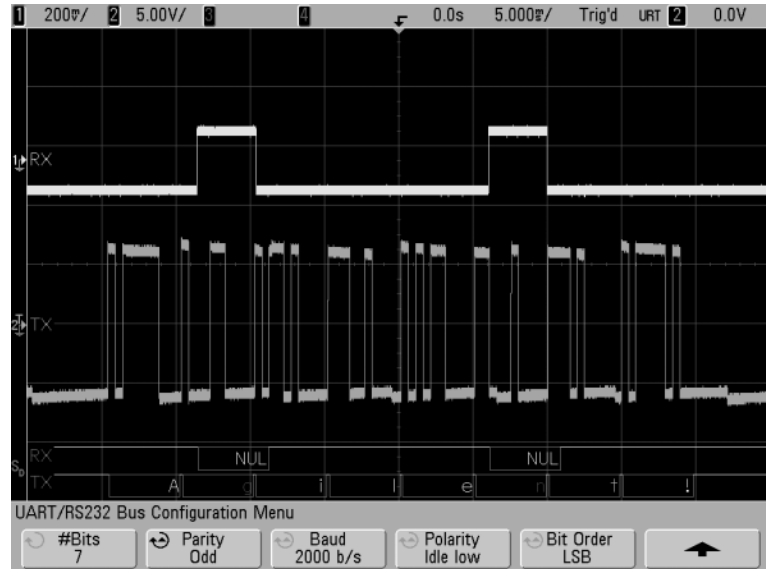

- Angled waveforms show an active bus (inside a packet/frame).
- Mid-level blue lines show an idle bus.
- When using 5-8 bit formats, the decoded data is displayed in white (in binary, hex, or ASCII).
- When using the 9 bit format, all data words are displayed in green, including the 9th bit. The 9th bit is displayed on the left.
- When a data word value is selected for framing, it is displayed in light blue. When using 9-bit data words, the 9th bit will also be displayed in light blue.
- Decoded text is truncated at the end of the associated frame when there is insufficient space within frame boundaries.
- When the horizontal scale setting does not permit the display of all available decoded data, red dots will appear in the decoded bus to mark the location of hidden data. Expand the horizontal scale to allow the data to display.
- An unknown (undefined) bus is shown in red.

- A parity error will cause the associated data word to be shown in red, which includes the 5-8 data bits and the optional 9th bit.

UART/RS232 Totalizer

The UART/RS232 totalizer consists of counters that provide a direct measure of bus quality and efficiency. The totalizer appears on screen whenever UART/RS232 Decode is ON in the Serial Decode Menu.

The totalizer is running, counting frames and calculating the percentage of error frames, even when the oscilloscope is stopped (not acquiring data).

The ERR (error) counter is a count of Rx and Tx frames with parity errors. The TX FRAMES and RX FRAMES counts include both normal frames and frames with parity errors. When an overflow condition occurs, the counter displays **OVERFLOW**.

The counters can be reset to zero by pressing the **Reset UART Counters** softkey.

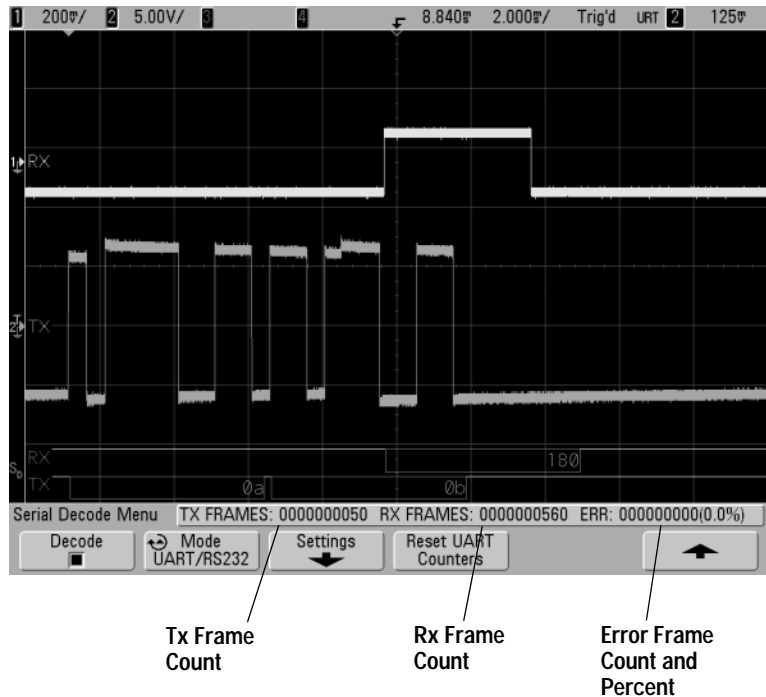

To reduce the random noise on a signal

If the signal you are probing is noisy, you can set up the oscilloscope to reduce the noise on the displayed waveform. First, you stabilize the displayed waveform by removing the noise from the trigger path. Second, you reduce the noise on the displayed waveform.

- 1 Connect a signal to the oscilloscope and obtain a stable display.
- 2 Remove the noise from the trigger path by turning on high-frequency rejection (HF reject), low-frequency rejection (LF reject), or noise rejection (see the following pages).
- 3 Use averaging (see page 279) to reduce noise on the displayed waveform.

HF Reject

High-frequency reject (HF reject) adds a low-pass filter with the 3-dB point at 50 kHz. HF reject removes high-frequency noise, such as AM or FM broadcast stations, from the trigger path.

- Press **Mode/Coupling&HF Reject**.

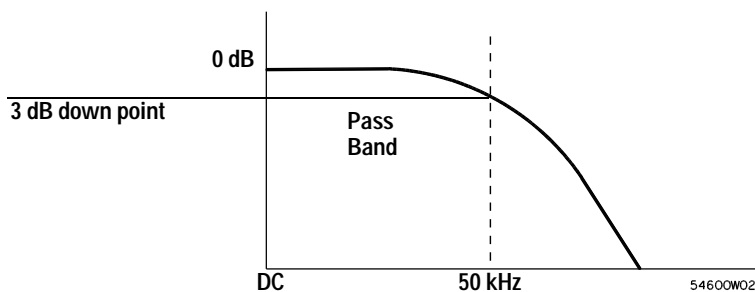

LF Reject

Low-frequency reject (LF reject) adds a high-pass filter with the 3-dB point at 50 kHz. LF reject removes low-frequency signals, such as power line noise, from the trigger path.

- Press **Mode/Coupling&Coupling&LF Reject**.

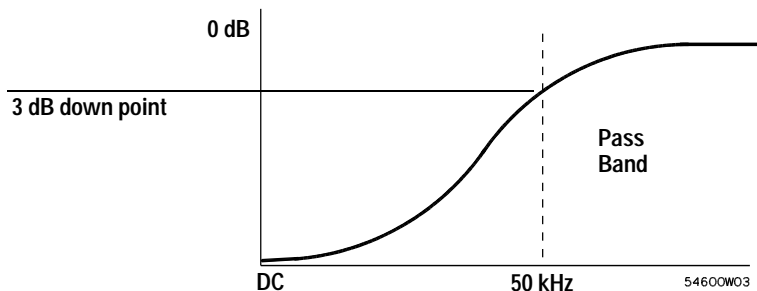

Noise rejection

Noise reject increases the trigger hysteresis band. By increasing the trigger hysteresis band, you reduce the possibility of triggering on noise. However, this also decreases the trigger sensitivity so that a slightly larger signal is required to trigger the oscilloscope.

- Press **Mode/Coupling&HF Reject**.

To capture glitches or narrow pulses with peak detect and infinite persistence

A glitch is a rapid change in the waveform that is usually narrow as compared to the waveform. Peak detect mode can be used to more easily view glitches or narrow pulses. In peak detect mode, narrow glitches and sharp edges are displayed more brightly than when in Normal acquire mode, making them easier to see.

To characterize the glitch, use the cursors or the automatic measurement capabilities of the oscilloscope.

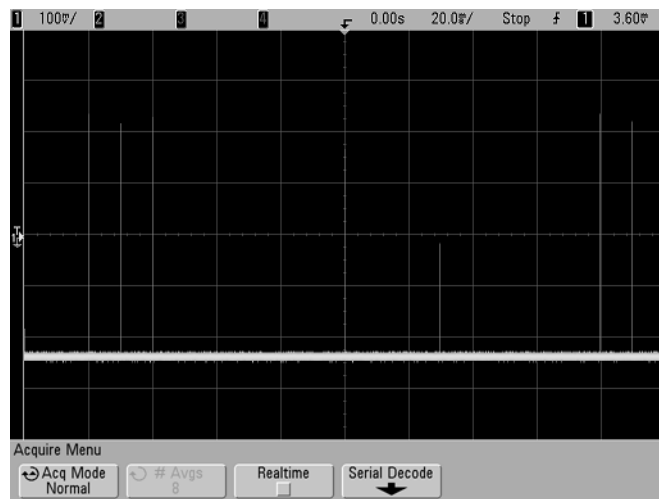

Figure 50 15 ns Narrow Pulse, 20 ms/div, Normal Mode



Figure 51 15 ns Narrow Pulse, 20 ms/div, Peak Detect Mode

Using peak detect mode to find a glitch

- 1 Connect a signal to the oscilloscope and obtain a stable display.
- 2 To find the glitch, press the **Acquire** key, then, press the **Acq Mode** softkey until **Peak Detect** is selected.
- 3 Press the **Display** key then press the ∞ **Persist** (infinite persistence) softkey.

Infinite persistence updates the display with new acquisitions but does not erase previous acquisitions. New sample points are shown at normal intensity while previous acquisitions are displayed in gray at lower intensity. Waveform persistence is not kept beyond the display area boundary.

Press the **Clear Display** softkey to erase previously acquired points. The display will accumulate points until ∞ **Persist** is turned off.

- 4 Characterize the glitch with zoom sweep:
 - a Press the **Menu/Zoom** key, then press the **Zoom** softkey.
 - b To obtain a better resolution of the glitch, expand the time base.
 - c Use the horizontal position knob (◀▶) to pan through the waveform to set the expanded portion of the normal sweep around the glitch.

How AutoScale Works

AutoScale automatically configures the oscilloscope to best display the input signals by analyzing any waveforms present at each channel and at the external trigger input. This includes the digital channels on MSO models.

AutoScale finds, turns on, and scales any channel with a repetitive waveform that has a frequency of at least 50 Hz, a duty cycle greater than 0.5%, and an amplitude of at least 10 mV peak-to-peak. Any channels that do not meet these requirements are turned off.

The trigger source is selected by looking for the first valid waveform starting with external trigger, then continuing with the highest number analog channel down to the lowest number analog channel, and finally (if the oscilloscope is an MSO) the highest number digital channel.

During AutoScale, the delay is set to 0.0 seconds, the sweep speed setting is a function of the input signal (about 2 periods of the triggered signal on the screen), and the triggering mode is set to edge. Vectors remain in the state they were before the AutoScale.

Undo AutoScale

Press the **Undo AutoScale** softkey to return the oscilloscope to the settings that existed before you pressed the **AutoScale** key.

This is useful if you have unintentionally pressed the **AutoScale** key or do not like the settings AutoScale has selected and want to return to your previous settings.

Specifying the Channels Displayed After AutoScale

The **Channels** softkey selection determines which channels will be displayed on subsequent AutoScales.

- **All Channels** – The next time you press **AutoScale**, all channels that meet the requirements of AutoScale will be displayed.
- **Only Displayed Channels** – The next time you press **AutoScale**, only the channels that are turned on will be examined for signal activity. This is useful if you only want to view specific active channels after pressing **AutoScale**.

Preserving the Acquisition Mode During AutoScale

The acquisition mode is normally switched to Normal when AutoScale is performed. AutoScale can be set to leave the acquisition mode unchanged if you prefer this option.

Choose Normal to make the oscilloscope switch to Normal acquisition mode whenever the **AutoScale** key is pressed. This is the default mode.

Choose Preserve to make the oscilloscope remain in the acquisition mode you have chosen when the **AutoScale** key is pressed.

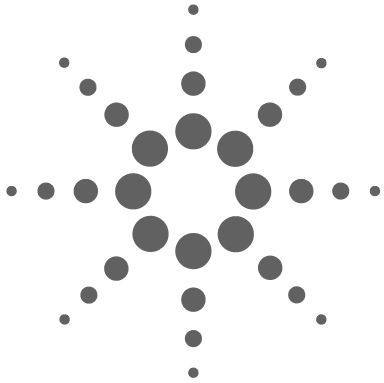

7 Saving and Printing Data

- Print options 353
- Supported Printers 355
- Saving oscilloscope data 356
- Selecting a destination for your saved data 357
- Selecting a file name 358
- Waveform Trace and Oscilloscope Setup 360
- Display Image and Waveform Data File Formats 360
- Choosing save settings 362
 - To save a waveform and/or setup to a USB device 366
 - To save a waveform and/or setup to the oscilloscope's internal memory 368
 - To recall waveform trace and/or oscilloscope setup 368
- File explorer 368
 - To use the file explorer 371
- Secure Environment Mode Option 372



Printing the oscilloscope's display

Quick Print

On earlier oscilloscopes the “**Print**” key was labeled “**Quick Print**” and the oscilloscope attempted to print or save as soon as the key was pressed.

On new oscilloscopes the key is labeled **Print**, and by default, when it is pressed the Print Configuration Menu is displayed.

Now you can select whether pressing the key displays the Print Configuration Menu or performs a Quick Print.

To select Print or Quick Print functionality:

- 1 Press Save/Recall.
- 2 Press the Quick Print softkey to set Quick Print on or off.

When Quick Print is enabled, a Save function is performed immediately when the **Print** (or **Quick Print**) key is pressed. The save parameters must be set up in the **Save/Recall** menu (see page 356) before pressing **Print**.

To print the oscilloscope's display

- 1 Connect a USB printer to either the USB port on the front panel or the rectangular USB host port on the rear panel. A list of supported printers is on page 355.
- 2 Press the **Print** key (labeled **Quick Print** on older models) on the front panel.
- 3 Press the **Press to Print** softkey.

NOTE

The oscilloscope will print the last menu visited before you pressed the **Print** key. Therefore, if you have measurements (Amplitude, Frequency, etc.) showing on the display before you select Print, the measurements will be shown on the printout.

To print the display showing the Print Configuration Menu at the bottom, press the **Print** key twice, then press the **Press to Print** softkey.

Print options

In print options, you can choose whether to:

- include setup information on the printout
- print on a white background to conserve printer ink
- print setup information on the same page or a new page
- print in portrait or landscape mode
- print in color or grayscale

The Print Configuration menu is displayed when you press the **Print** key. The print option softkeys and the **Press to Print** softkey are ghosted (not available) until a printer is connected.

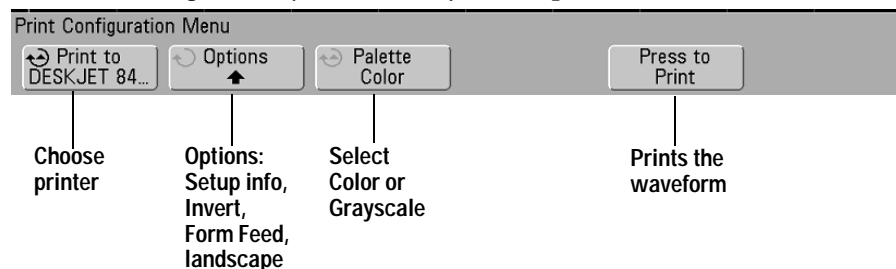

Selecting print options

Press the **Options** softkey to change the following options:

- **Setup Information** – Select to print oscilloscope setup information on your printout, including vertical, horizontal, trigger, acquisition, math, and display settings.
- **Invert Graticule Colors** – The **Invert Graticule Colors** option can be used to reduce the amount of black ink it takes to print oscilloscope images by changing the black background to white. **Invert Graticule Colors** is the default mode.

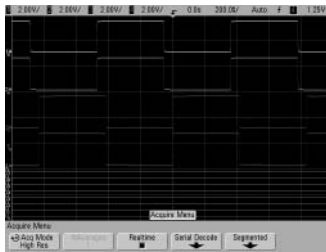

Graticule Not Inverted

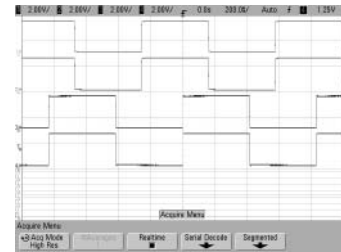

Graticule Inverted

- **Form Feed** – The **Form Feed** option can be selected to send a form feed command to the printer after the waveform is printed and before the setup information is printed. Switch **Form Feed** off if you want setup information printed on the same sheet of paper with the waveform. This option only has an effect when the **Setup Information** option is selected. Also, if the amount of setup information will not fit on the same page with the waveform, it will be printed on a new page regardless of the **Form Feed** setting.
- **Landscape** – Choose **Landscape** mode to print horizontally on the page instead of vertically (portrait mode).

Palette

Press the **Palette** softkey to change the following options.

- **Color** – When **Color** printing is selected, the traces are printed in color.
- **Grayscale** – When **Grayscale** printing is selected, the traces are printed in shades of gray rather than in color.

Supported Printers

For the most up-to-date listing of printers that are compatible with the InfiniiVision 6000 Series oscilloscopes, please visit www.agilent.com/find/InfiniiVision-printers.

Saving oscilloscope data

Here are a few points about saving oscilloscope data:

- You can save a waveform trace and recall it later. The recalled trace appears in cyan (blue).
- You can save oscilloscope setup parameters and recall them later. The setup file stores settings such as horizontal timebase, vertical sensitivity, trigger mode, trigger level, measurements, cursors, and math functions. This lets you easily and consistently set up the oscilloscope to make a particular measurement.
- There is a distinction between print and save: print always refers to printing the display to a printer. Save means saving data to a USB drive or the oscilloscope's internal memory.

The following table shows types of data and where the data can be saved.

Table 17 Saving Oscilloscope Data

Type of Data	Can be saved to:	
	USB drive	Oscilloscope's internal memory
Oscilloscope setup and waveform trace	Yes	Yes*
Display image and waveform data files (BMP, PNG, CSV, ASCII XY, ALB, BIN)	Yes	No
*If Secure Environment Mode option is installed then data is prevented from being stored in the oscilloscope's internal memory.		

NOTE

You can also save the oscilloscope's display image using a web browser. See "Printing the oscilloscope's display from a web browser" on page 55 for details.

Selecting a destination for your saved data

Press **Save/Recall**→**Save** to access the Save menu and select a destination for saving your data.

Press to go/Location/Save to softkey (Using the oscilloscope's File Explorer)

The second softkey from the left in the Save menu is the file explorer softkey.

If no USB storage device is connected to the oscilloscope, you will only be able to save Trace and Setup files to the oscilloscope's internal memory. You will not be able to save display image files or waveform data files as described on page 360 unless a USB storage device is connected.

Rotate the Entry knob to align the selection arrow with “C:” and push the **Press to go** softkey to select the destination. Then rotate the Entry knob to align the arrow with the “**setups**” directory and press the **Save to** softkey to select a file (**intern_n**) to be overwritten.

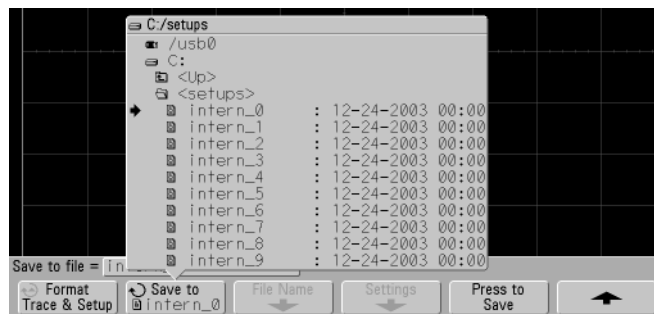

NOTE

The File Explorer in the Save and Recall menus can be used to save the following file types: oscilloscope setup, waveform trace, display image and waveform data. It can be used to recall oscilloscope setup and waveform trace files.

The File Explorer in the Utility menu can be used for loading files into the oscilloscope or deleting files.

If one or more USB storage devices are connected to the oscilloscope, you can navigate to the USB device using the same method. The following display image shows an image ready to be saved to a subfolder called “Rise time” on a USB device. Push the **Press to Save** softkey to save the image.

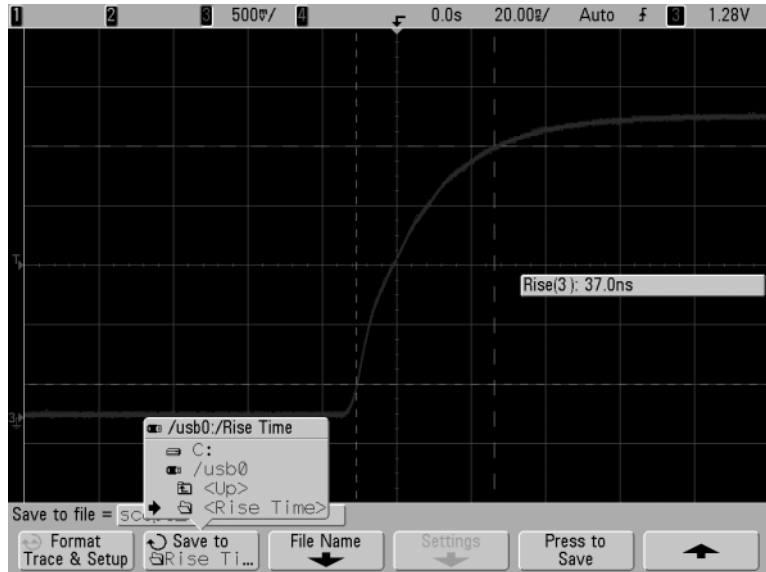

Selecting a file name

Overwriting a file

You can choose to overwrite an existing file name by browsing to that file and selecting it, then choosing **Press to Save**.

Creating a new file name

- 1 Press the **File Name** softkey in the Save menu. (You must have a USB storage device connected to the oscilloscope for this softkey to be active.)
- 2 Repeatedly turn and push the Entry knob to select letters and numbers for the new file name. Or, you can press the

- Spell** softkey and press the **Enter** softkey to create the new file name.
- 3 You can press the **Enter** softkey or the Entry knob to move the cursor forward within the file name.
 - 4 You can press the **Delete Character** softkey to delete the current character and shift the rest of the characters to the left.
 - 5 When you select the **Auto Increment** option, the oscilloscope will add a numeric suffix to your file name, and increment the number with each successive save. It will truncate characters as necessary when the file name length is at maximum and more digits are required for the numeric portion of the file name.
 - 6 Press the **Press to Save** softkey to save the file.

Waveform Trace and Oscilloscope Setup

When the **Trace & Setup** option is selected from the **Format** softkey, both waveform trace and oscilloscope setup are saved to the USB drive or the oscilloscope's internal memory. After saving, you can choose to recall the trace, the setup, or both.

The trace is saved with the file extension TIF and the setup is saved with the extension SCP. These extensions can be seen using the File Explorer, but they do not appear when using the file browser in the Recall menu. When using Mask Testing, the mask data file is saved also. Its extension is MSK.

Display Image and Waveform Data Files

You can save the display image in the following file formats:

- BMP
- PNG

You can save waveform data in the following formats:

- CSV
- ASCII
- BIN
- ALB
- MSK

Serial Decode Data

Serial decode data is saved in BMP and PNG image file formats and in ASCII XY data file format.

Display Image and Waveform Data File Formats

The data that is displayed on-screen is the data that will be saved to the file. Exception: when using Mask test the

Display image and waveform data files can be saved on a USB mass storage device, but they can not be saved to the oscilloscope's internal memory.

You can save the display image or waveform data in image (BMP, PNG) or data (CSV, ASCII, BIN, ALB) file formats. Press **Save/Recall**→**Save**→**Format** to select a format.

- **BMP (8-bit) image file** - The screen image is converted to a smaller, lower resolution bitmap file of the complete screen (including the status line and softkeys).
- **BMP (24-bit) image file** - This is a larger, high-resolution bitmap file of the complete screen.
- **PNG (24-bit) image file** - This is an image file that uses lossless compression. Files are much smaller than the BMP format.
- **CSV data file** - This creates a file of comma-separated variable values of all displayed channels and math waveforms. This format is suitable for spreadsheet analysis.
- **ASCII XY data file** - This creates a file of comma-separated variables for each displayed channel. If the oscilloscope acquisition is stopped, then data records greater than 1000 points can be written. This format is also suitable for spreadsheets.
- **BIN data file** - This creates a binary file with a header, and data in the form of time and voltage pairs. This file is much smaller than the ASCII XY data file. If the oscilloscope acquisition is stopped, then data records greater than 1000 points can be written.
- **ALB data file** - This creates a file in an Agilent proprietary format which can be read by Agilent logic analyzers. You can use Agilent's B4610A Data import tool for offline viewing and analysis.
- **Mask test data file** - This creates a mask file in an Agilent proprietary format which can be read by Agilent InfiniiVision oscilloscopes. A mask data file includes certain setup information, but not all setup information. To save all setup information including the mask data file, choose "Trace and Setup" format instead. (See also "Using Mask Test" on page 287.)

Choosing save settings

Press **Save/Recall**→**Save**→**Settings** to change the following options. A USB storage device (such as a thumb drive) must be connected to the oscilloscope.

These settings are not applicable when the format “Trace&Setup” is selected.

Setup Info

Select **Setup Info** if you want the oscilloscope setup information to be included. Oscilloscope setup information includes vertical, horizontal, trigger, acquisition, math, and display settings. The setup information will be sent to a separate file with a TXT extension.

Invert Graticule Colors

This setting is applicable when you have chosen BMP or PNG using the **Format** softkey.

The **Invert Graticule Colors** option can be used to reduce the amount of black ink it takes to print oscilloscope images by changing the black background to white. **Invert Graticule Colors** is the default mode. **Invert Graticule Colors** is available when the BMP and PNG formats are selected.

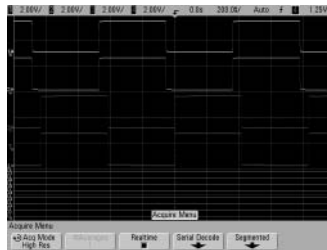

Graticule Not Inverted

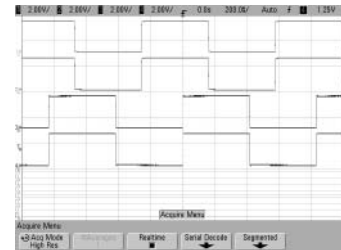

Graticule Inverted

Palette

Press the **Palette** softkey to change the following options. The **Palette** options are available when the BMP and PNG formats are selected.

- **Color** – When **Color** printing is selected, the traces are printed in color. Color printing is not applicable to CSV format.
- **Grayscale** – When **Grayscale** printing is selected, the traces are printed in shades of gray rather than in color. Grayscale printing is not applicable to CSV format.

Length Control

The **Length** softkey is available when the CSV, ASCII XY, BIN, or ALB formats are selected. **Length** sets the number of data points that will be output to the file. **Length** can be set to 100, 250, 500, or 1000 when the acquisition is running, or more when the acquisition is stopped. (CSV length is limited to 1000 points.) It is important to save enough points to represent the captured data accurately. Press the Single key to obtain the maximum record length.

The maximum available record length depends on whether one or two channels are active (turned on) per channel pair (channel pairs are channels 1&2 and channels 3&4), whether digital channels are on or off, and the horizontal timebase setting (how much data is shown on screen).

Only displayed data points are output (except when you are using segmented memory and the **Save Segment** control is set to **All segments**). Therefore, adjust the Horizontal controls to display the data you want to save.

The length control has no effect on the amount of Serial Decode data saved; all serial decode data will be output.

The Length control will perform a “1 of n” decimation of the data when necessary. For example: if the **Length** is set to 1000, and you are displaying a record that is 5000 data points in length, four of each five data points will be decimated, creating an output file 1000 data points in length. However, if serial decode is on, no decimation will occur.

For more information see “CSV and ASCII XY files” on page 396.

Save Segment

When using the optional segmented memory feature you can choose to save either the currently displayed segment or all acquired segments in memory. (See also page 286.) Press **Save/Recall**→**Save**→**Format** (choose CSV, ASCII XY, or BIN)→**Settings**→**Save Seg** to make your selection. Set the Length control appropriately (see Length Control, above).

Segmented memory save formats

Segmented memory data can be saved as a screen capture (in BMP or PNG format) or in CSV, ASCII XY, or BIN (data file format). The Save Segment setting is relevant to data file formats, not screen capture formats.

When saving waveform capture at maximum memory depth, you can expect the following approximate save times:

CSV	2 hours
ASCII XY	30 minutes
BIN	3 minutes

The primary difference between CSV format and ASCII XY data format is that in CSV all data are presented as columns in a single spreadsheet file, whereas in ASCII XY the data are presented in separate files for channel 1, channel 2, channel 3, channel 4, digital channels 0-7, digital channels 8-15, and math waveforms.

For more information, see:

- “Binary Data (.bin)” on page 388
- “CSV and ASCII XY files” on page 396

Format (ALB data file format settings in Save menu)

You can acquire data from the oscilloscope in ALB format, then analyze it offline (on a PC) using the Agilent *B4610A Data Import Tool for Offline Viewing and Analysis*. See Agilent publication number 5989-7834EN at www.Agilent.com.

When you choose any ALB format other than Default, waveforms from the analog channels (if displayed) are also digitized and displayed as digital waveforms. The analog channel's trigger level determines the point at which the voltage is considered a logic 1 or 0.

Available ALB serial formats include:

- Default
- CAN
- I2C
- LIN
- UART/RS232
- SPI (2 Wire Serial)
- SPI (3 Wire Serial)
- SPI (4 Wire Serial)

To select a serial format for the ALB data file:

- 1 Press **Save/Recall**→**Save**.
- 2 Press **Format** and select ALB.
- 3 Press **Settings**.
- 4 Press **Format** and select the format for the ALB data file.

If you connect your serial bus signals to the oscilloscope as shown in the following table, the labels in the analysis software will be correct. If you do not, then you will have to re-map the signals in the analysis software.

Table 18 Recommended Signal Mapping

Label	Signal	Scope Channel	Maps to Logic Analyzer Channel
TxRS232	Tx	Ch1	D0
RxRS232	Rx	Ch2	D1
I2C	Data	Ch1	D0
I2C	Clk	Ch2	D1

Table 18 Recommended Signal Mapping

Label	Signal	Scope Channel	Maps to Logic Analyzer Channel
SPI2 (2-wire)	Clk	Ch1	D0
SPI2	Data	Ch2	D1
SPI3 (3-wire)	~Chip Select	Ch1	D0
SPI3	Clk	Ch2	D1
SPI3	Data	Ch3	D2
SPI4 (4-wire)	~Chip Select	Ch1	D0
SPI4	Clk	Ch2	D1
SPI4	DataIn	Ch3	D2
SPI4	DataOut	Ch4	D3
CAN	Data	Ch1	D0
LIN	Data	Ch1	D0

To save a waveform and/or setup to a USB device

- 1 Insert a USB drive into the front or rear USB device port.
- 2 Press the **Save/Recall** key.
- 3 Press the **Save** softkey. The proposed file name will be shown in the “**Save to file**” prompt above the **Save** softkey. (If you want to change the file name, press the **File Name** softkey. See “Creating a new file name” on page 358 for details.)
- 4 Choose a file format using the **Format** softkey. For file format information see “Display Image and Waveform Data File Formats” on page 360.
- 5 Press the **Press to Save** softkey.

NOTE

When saving display image files, the oscilloscope will save an image using the last menu you visited before pressing the **Print** key. Therefore, if you have measurements (Amplitude, Frequency, etc.) showing on the display before you select Save, the measurements will be shown in the display image file.

To save an image of the display showing the Save/Recall Menu at the bottom, press the **Save/Recall** key twice, then press the **Press to Save** softkey.

To save a waveform and/or setup to the oscilloscope's internal memory

- 1 Press the **Save/Recall** key.
- 2 Press the **Save** softkey.
- 3 Press the **Format** softkey and choose **Trace and Setup**.
- 4 Press the **Save to** softkey. Then rotate the **Entry** knob to navigate to the "C:\setups" directory, then choose one of the files to overwrite (intern_0 through intern_9). You can push the **Entry** knob to make your directory and file selections.
- 5 Press the **Press to Save** softkey or select the file using the **Entry** knob and then press the **Entry** knob.

To recall waveform trace and/or oscilloscope setup

A recalled trace is typically used for a quick comparison of measurement results. For example, you might save a trace of a waveform to use as a reference, then make a similar measurement on a test system and then recall the saved trace to observe any differences.

- 1 Press the **Save/Recall** key.
- 2 Press the **Recall** softkey. The Recall Menu will be displayed.
- 3 Press the **Recall:** softkey in the Recall Menu and choose **Setup, Trace,** or **Trace and Setup**.
- 4 Press the second softkey from the left and navigate to the oscilloscope's internal memory location or the USB drive that holds the saved trace and/or setup. See "File explorer" (below) for more information.
- 5 Press the **Press to Recall** softkey.

File explorer

The File Explorer lets you navigate the file system. Using the File Explorer you can save, recall, load, and delete files.

File system The user-accessible file system consists of ten internal memory locations, plus external USB memory devices you connect to the USB device ports on the oscilloscope.

Internal memory The ten internal nonvolatile memory locations are located on the oscilloscope at C:\setups and are named intern_0 through intern_9. You can save waveform trace and oscilloscope setup in each of the ten internal memory locations, but you can not save display image files or waveform data files in the oscilloscope's internal memory. The latter must be stored on USB devices.

USB devices Most USB storage devices are compatible with the oscilloscope. However, certain devices may be incompatible, and may not be able to be read or written to.

When the USB storage device is connected to the oscilloscope's front or rear USB host port, a small four-color circle icon may be displayed briefly as the USB device is read.

You do not need to "eject" the USB device before removing it. Simply ensure that any file operation you've initiated is done, and remove the USB drive from the oscilloscope's host port.

Do not connect USB devices that identify themselves as hardware type "CD" because these devices are not compatible with the 6000 Series oscilloscopes.

If two USB mass storage devices are connected to the oscilloscope, the first one is designated "USB0" and the second one is designated "USB5," not "USB1." This numbering method is normal; it is inherent in the USB driver.

A file that has been deleted from the USB mass storage device cannot be recovered by the oscilloscope.

NOTE

Regarding USB Ports:

The USB port on the front panel, and the USB port on the rear panel labeled "HOST" are USB Series A receptacles. These are the receptacles to which you can connect USB mass storage devices and printers.

The square receptacle on the rear panel labeled "DEVICE" is provided for controlling the oscilloscope over USB. See the *InfiniiVision 6000 Series Oscilloscopes Programmer's Quick Start Guide* or the *InfiniiVision 6000 Series Oscilloscopes Programmer's Reference* for more information. To access these documents online, point your web browser to www.agilent.com/find/6000 and select Library.

System software System software files (software updates which can be downloaded from www.agilent.com/find/6000sw) can be loaded into the oscilloscope. See "Software and firmware updates" on page 376 for more information.

To use the file explorer

Files can be loaded and deleted using the file explorer.

You can create directories on a USB mass storage device using your PC or other instrument. You can navigate to any directory on the USB device by rotating the Entry knob and pressing the softkey.

- 1 Connect a USB mass storage device with the files to be loaded or deleted to the USB port on the front or the rear of the oscilloscope. A small four-color circle icon may be displayed as the USB device is read.
- 2 Press **Utility&File Explorer**.
- 3 Turn the Entry knob to select the desired file on the USB mass storage device. The left-most softkey will be labeled **Press to go** when pointing at a directory that can be selected, **Location** when pointing to a directory that is currently selected, and **Selected** when pointing to a file that can be loaded or deleted. Pressing the softkey will initiate the selected activity.

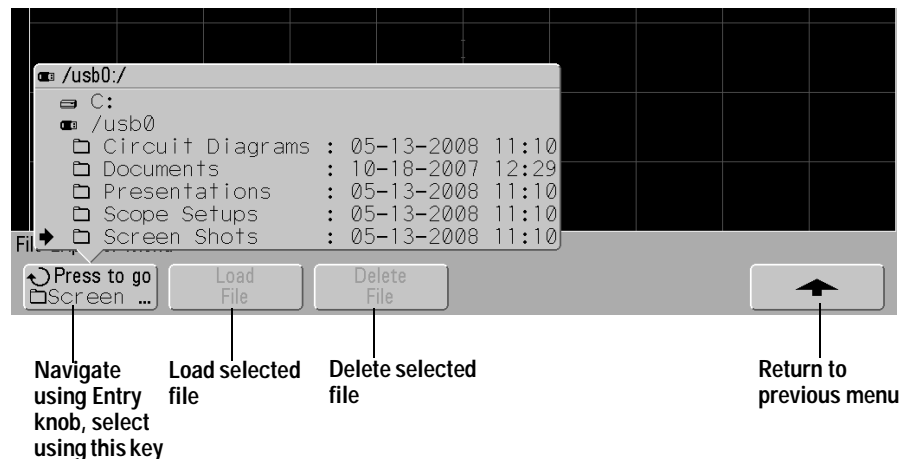

Secure Environment Mode Option

Secure environment mode is compliant to National Industrial Security Program Operating Manual (NISPOM) Chapter 8 requirements.

Secure environment mode is called option SEC when it is ordered with the oscilloscope. When adding secure environment mode after oscilloscope purchase, the option is called model N5427A, and the oscilloscope must be returned to an Agilent service center for installation.

When secure environment mode is installed, trace and setup data are stored to internal volatile memory (rather than internal non-volatile memory). Oscilloscope setup, waveform, and trace data are erased when the power is shut off. This ensures that any setup, waveform, and trace data will not be visible to the next user upon power-up. The clock, LAN, and GPIB settings are not discarded upon power-down.

To permanently store data, you can save it to an external device through one of the oscilloscope's USB ports.

Once installed, secure environment mode can not be disabled. Secure environment mode is available beginning with system software version 3.50. As a precaution against attempting to defeat secure environment mode, this option prevents older software from being installed.

When installed, the secure environment mode license will appear as SEC in the Installed Licenses line of the "About Oscilloscope" display. To access the About Oscilloscope display, press the **Utility** key, then press the **Service** softkey, then press the **About Oscilloscope** softkey.

Table 19 Ordering the Secure Environment Mode Option

Ordering the Secure Environment Mode Option	
New oscilloscope purchase...	Order Option SEC.
After oscilloscope purchase, if you have not saved confidential trace or setups on the oscilloscope...	Order N5427A and return the unit to a Service Center for security license installation.
After oscilloscope purchase, if you have saved confidential trace or setups on the oscilloscope...	<ol style="list-style-type: none"> 1 Remove and destroy the acquisition board. 2 Purchase and install a new acquisition board. 3 Order N5427A and return the unit to a Service Center for security license installation.

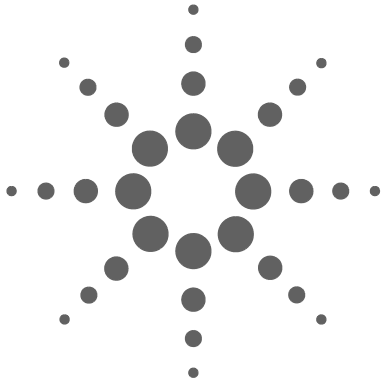

8 Reference

- Upgrading to an MSO or adding memory depth 376
- Software and firmware updates 376
 - To set up the I/O port 377
 - Using the 10 MHz reference clock 378
 - To supply a sample clock to the oscilloscope 378
 - To synchronize the timebase of two or more instruments 380
 - To check warranty and extended services status 380
 - To return the instrument 381
 - To clean the oscilloscope 381
- Digital channel signal fidelity: Probe impedance and grounding 382
 - To replace digital probe leads 387
- Binary Data (.bin) 388
- CSV and ASCII XY files 396
- VPT1000 IP address and firmware updates 398



Upgrading to an MSO or adding memory depth

A license can be installed to activate the digital channels of an oscilloscope that was not originally ordered as a mixed-signal oscilloscope (MSO). This includes 6000A Series and 6000L Series oscilloscopes. A mixed signal oscilloscope has analog channels plus 16 time-correlated digital timing channels.

A license can also be installed to increase the memory depth of an oscilloscope that was not originally ordered with the maximum memory depth available. All 6000L Series oscilloscopes are shipped from the factory with maximum memory depth enabled.

To view the currently installed licenses press **Utility&Options&Features&Show license information**.

For information about upgrading your oscilloscope through licensing, contact your local Agilent Technologies representative or see www.agilent.com/find/6000.

Software and firmware updates

From time to time Agilent Technologies releases software and firmware updates for its products. To search for firmware updates for your oscilloscope, point your web browser to www.agilent.com/find/6000 and select **Technical Support**, then select **Software Downloads & Utilities**.

To view the currently installed software and firmware press **Utility&Service&About Oscilloscope**.

To set up the I/O port

The oscilloscope can be controlled via GPIB, LAN, or USB.

The oscilloscope's I/O configuration, including its IP address and hostname, can be viewed by pressing **Utility&I/O**.

To change the I/O controller settings, press the **Configure** softkey, and choose the I/O connection type (GPIB, LAN, or USB).

For instructions on setting up the oscilloscope to run from a controller via LAN, GPIB, or USB, see the *Agilent InfiniiVision 6000 Series Oscilloscopes Programmer's Quick Start Guide*.

Using the 10 MHz reference clock

The 10 MHz REF BNC connector on the rear panel is provided so you can:

- Supply a more accurate sample clock signal to the oscilloscope, or
- Synchronize the timebase of two or more instruments.

Sample clock and frequency counter accuracy

The oscilloscope's timebase uses a built-in reference that has an accuracy of 15 ppm. This is sufficient for most uses. However, if you are looking at a window that is very narrow compared to the selected delay (for example, looking at a 15 ns pulse with the delay set to 1 ms), significant error can be introduced.

Using the built-in sample clock, the oscilloscope's hardware frequency counter is a 5-digit counter.

Supplying an external timebase reference

When you supply an external timebase reference, the hardware frequency counter is automatically changed to an 8-digit counter. In this case, the frequency counter (**Quick Meas&Select&Counter**) is as accurate as the external clock.

For more information on the hardware frequency counter, see "Counter" on page 254.

To supply a sample clock to the oscilloscope

- 1 Connect a 10 MHz square or sine wave to the BNC connector labeled 10 MHz REF. The amplitude must be between 180 mV and 1 V, with an offset of between 0 V and 2 V.

CAUTION



Maximum input voltage for 10 MHz reference input

Do not apply more than ± 15 V at the 10 MHz REF BNC connector on the rear panel or damage to the instrument may occur.

- 2 Press **Utility&Options&Rear Panel&Ref Signal**.
- 3 Use the Entry Knob and the **Ref Signal** softkey to select **10 MHz input**.

A black locked padlock icon will appear at the top of the display.

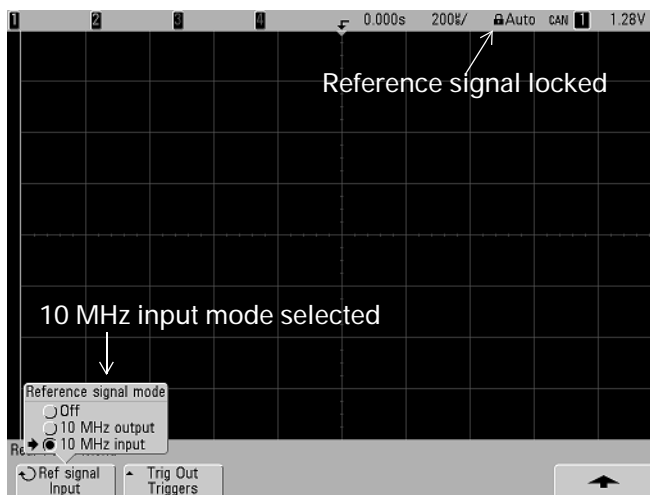

If the externally supplied sample clock varies greater than 0.5% from 10 MHz a soft unlock will occur. The oscilloscope will continue to acquire data but the lock symbol in the upper right part of the display will become a red unlocked padlock icon.

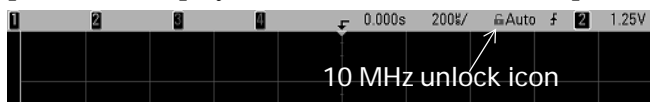

If the externally supplied sample clock signal is lost, a hard unlock will occur. The lock symbol in the upper right part of the display will become a red unlocked padlock icon and the oscilloscope will stop acquiring data. The oscilloscope will resume sampling when the externally supplied sample clock becomes stable again.



To synchronize the timebase of two or more instruments

The oscilloscope can output its 10 MHz system clock for the purpose of synchronization with other instruments.

- 1 Connect a BNC cable to the BNC connector labeled **10 MHz REF** on the rear panel of the oscilloscope.
- 2 Connect the other end of the BNC cable to the instrument(s) that will accept the 10 MHz reference signal. Put a 50 Ω termination at the input to the other instrument to terminate the signal.
- 3 Press **Utility&Options&Rear Panel&Ref Signal**.
- 4 Use the Entry Knob and the **Ref Signal** softkey to select **10 MHz output**.

The oscilloscope will output its 10 MHz reference signal at TTL levels.

To check warranty and extended services status

To learn the warranty status of your oscilloscope:

- 1 Point your web browser to:
www.agilent.com/find/warrantystatus
- 2 Enter your product's model number and serial number. The system will search for the warranty status of your product and display the results. If the system cannot find your product's warranty status, select **Contact Us** and speak with an Agilent Technologies representative.

To return the instrument

Before shipping the oscilloscope to Agilent Technologies, contact your nearest Agilent Technologies sales or service office for additional details. Information on contacting Agilent Technologies can be found at www.agilent.com/find/contactus.

1 Write the following information on a tag and attach it to the oscilloscope.

- Name and address of owner
- Model number
- Serial number
- Description of service required or failure indication

2 Remove accessories from the oscilloscope.

Only return accessories to Agilent Technologies if they are associated with the failure symptoms.

3 Package the oscilloscope.

You can use the original shipping container, or provide your own materials sufficient to protect the instrument during shipping.

4 Seal the shipping container securely, and mark it FRAGILE.

To clean the oscilloscope

1 Remove power from the instrument.

2 Clean the external surfaces of the oscilloscope with a soft cloth dampened with a mixture of mild detergent and water.

3 Make sure that the instrument is completely dry before reconnecting it to a power source.

Digital channel signal fidelity: Probe impedance and grounding

You may encounter problems when using the mixed-signal oscilloscope that are related to probing. These problems fall into two categories: probe loading and probe grounding. Probe loading problems generally affect the circuit under test, while probe grounding problems affect the accuracy of the data to the measurement instrument. The design of the probes minimizes the first problem, while the second is easily addressed by good probing practices.

Input Impedance

The logic probes are passive probes, which offer high input impedance and high bandwidths. They usually provide some attenuation of the signal to the oscilloscope, typically 20 dB.

Passive probe input impedance is generally specified in terms of a parallel capacitance and resistance. The resistance is the sum of the tip resistor value and the input resistance of the test instrument (see the following figure). The capacitance is the series combination of the tip compensating capacitor and the cable, plus instrument capacitance in parallel with the stray tip capacitance to ground. While this results in an input impedance specification that is an accurate model for DC and low frequencies, the high-frequency model of the probe input is more useful (see the following figure). This high-frequency model takes into account pure tip capacitance to ground as well as series tip resistance, and the cable's characteristic impedance (Z_0).

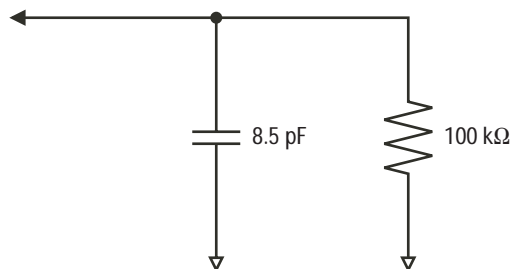

Figure 52 DC and Low-Frequency Probe Equivalent Circuit

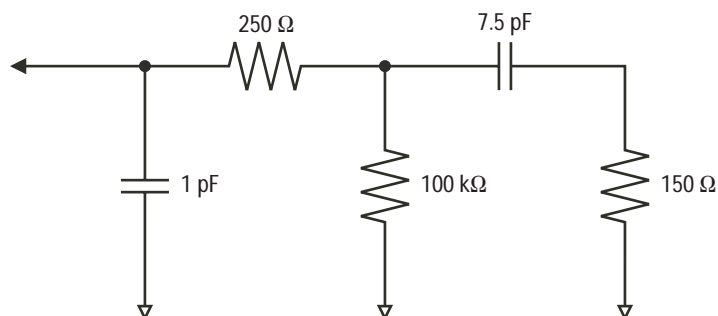

Figure 53 High-Frequency Probe Equivalent Circuit

The impedance plots for the two models are shown in these figures. By comparing the two plots, you can see that both the series tip resistor and the cable's characteristic impedance extend the input impedance significantly. The stray tip capacitance, which is generally small (1 pF), sets the final break point on the impedance chart.

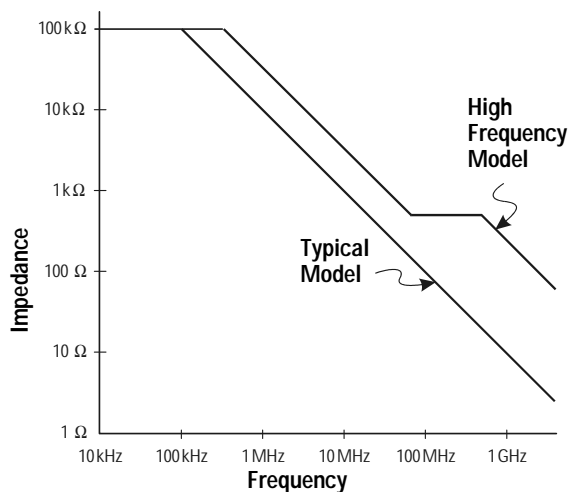

Figure 54 Impedance versus Frequency for Both Probe Circuit Models

The logic probes are represented by the high-frequency circuit model shown above. They are designed to provide as much series tip resistance as possible. Stray tip capacitance to ground is minimized by the proper mechanical design of the probe tip assembly. This provides the maximum input impedance at high frequencies.

Probe Grounding

A probe ground is the low-impedance path for current to return to the source from the probe. Increased length in this path will, at high frequencies, create large common mode voltages at the probe input. The voltage generated behaves as if this path were an inductor according to the equation:

$$V = L \frac{di}{dt}$$

Increasing the ground inductance (L), increasing the current (di) or decreasing the transition time (dt), will all result in increasing the voltage (V). When this voltage exceeds the threshold voltage defined in the oscilloscope, a false data measurement will occur.

Sharing one probe ground with many probes forces all the current that flows into each probe to return through the same common ground inductance of the probe whose ground return is used. The result is increased current (di) in the above equation, and, depending on the transition time (dt), the common mode voltage may increase to a level that causes false data generation.

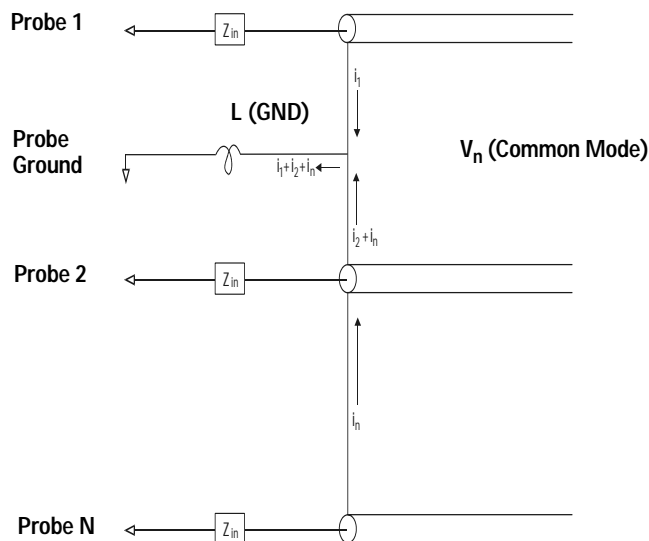

Figure 55 Common Mode Input Voltage Model

In addition to the common mode voltage, longer ground returns also degrade the pulse fidelity of the probe system. Rise time is increased, and ringing, due to the undamped LC circuit at the input of the probe, is also increased. Because the digital channels display reconstructed waveforms, they do not show ringing and perturbations. You will not find ground problems through examination of the waveform display. In fact, it is likely you will discover the problem through random glitches or inconsistent data measurements. Use the analog channels to view ringing and perturbations.

Best Probing Practices

Because of the variables L , di , and dt , you may be unsure how much margin is available in your measurement setup. The following are guidelines for good probing practices:

- The ground lead from each digital channel group (D15–D8 and D7–D0) should be attached to the ground of the circuit under test if any channel within the group is being used for data capture.
- When capturing data in a noisy environment, every third digital channel probe's ground should be used in addition to the channel group's ground.
- High-speed timing measurements (rise time < 3 ns) should make use of each digital channel probe's own ground.

When designing a high-speed digital system, you should consider designing dedicated test ports that interface directly to the instrument's probe system. This will ease measurement setup and ensure a repeatable method for obtaining test data. The 01650-61607 16-channel logic probe and termination adapter is designed to make it easy to connect to industry-standard, 20-pin board connectors. This probe consists of a 2 m logic analyzer probe cable and a 01650-63203 termination adapter that provides the proper RC networks in a very convenient package. Three 20-pin, low-profile, straight board connectors are included. Additional board connectors can be ordered from Agilent Technologies.

To replace digital probe leads

If you need to remove a probe lead from the cable, insert a paper clip or other small pointed object into the side of the cable assembly, and push to release the latch while pulling out the probe lead.

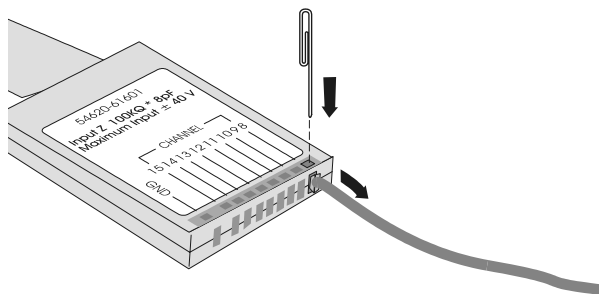

Table 20 Digital Probe Replacement Parts

Part Number	Description
54620-68701	Digital probe kit
5959-9333	Replacement probe leads (qty 5)
5959-9335	Replacement 2-inch probe ground lead (qty 5)
01650-94309	Package of probe labels
54620-61801	16-channel cable (qty 1)
5090-4833	Grabbers (qty 20)

For other replacement parts, consult the *InfiniiVision 6000 Series Oscilloscope Service Guide*.

Binary Data (.bin)

The binary data format stores waveform data in binary format and provides data headers that describe that data.

Because the data is in binary format, the size of the file is approximately 5 times smaller than the ASCII XY format.

If more than one source is on, all displayed sources will be saved, except math functions.

When using segmented memory, each segment is treated as a separate waveform. All segments for a channel are saved, then all segments of the next (higher numbered) channel are saved. This continues until all displayed channels are saved.

When the oscilloscope is in the Peak Detect acquisition mode, the minimum and maximum value waveform data points are saved to the file in separate waveform buffers. The minimum value data points are saved first; then, the maximum value data points are saved.

BIN data - using segmented memory

When saving all segments, each segment has its own waveform header (see page 393).

In BIN file format, data are presented as follows:

- Channel 1 data (all segments)
- Channel 2 data (all segments)
- Channel 3 data (all segments)
- Channel 4 data (all segments)
- Digital channel data (all segments)
- Math waveform data (all segments)

When not saving all segments, the number of waveforms is equivalent to the number of active channels (including math and digital channels, with up to seven waveform for each digital pod). When saving all segments the number of waveforms is equal to the number of active channels multiplied by the number of segments acquired.

Binary Data in MATLAB

Binary data from the 6000 Series oscilloscope can be imported to The MathWorks MATLAB®. You can download the appropriate MATLAB functions from the Agilent Technologies web site at www.agilent.com/find/6000sw.

Agilent provides the .m files, which need to be copied into the work directory for MATLAB. The default work directory is C:\MATLAB7\work.

Binary Header Format

File Header

There is only one file header in a binary file. The file header consists of the following information.

Cookie Two byte characters, AG, that indicate the file is in the Agilent Binary Data file format.

Version Two bytes that represent the file version.

File Size A 32-bit integer that is the number of bytes that are in the file.

Number of Waveforms A 32-bit integer that is the number of waveforms that are stored in the file.

Waveform Header

It is possible to store more than one waveform in the file, and each waveform stored will have a waveform header. When using segmented memory, each segment is treated as a separate waveform. The waveform header contains information about the type of waveform data that is stored following the waveform data header.

Header Size A 32-bit integer that is the number of bytes in the header.

Waveform Type A 32-bit integer that is the type of waveform stored in the file:

- 0 = Unknown.
- 1 = Normal.
- 2 = Peak Detect.
- 3 = Average.
- 4 = Not used in 6000 Series oscilloscopes.
- 5 = Not used in 6000 Series oscilloscopes.
- 6 = Logic.

Number of Waveform Buffers A 32-bit integer that is the number of waveform buffers required to read the data.

Points A 32-bit integer that is the number of waveform points in the data.

Count A 32-bit integer that is the number of hits at each time bucket in the waveform record when the waveform was created using an acquisition mode like averaging. For example, when averaging, a count of four would mean every waveform data point in the waveform record has been averaged at least four times. The default value is 0.

X Display Range A 32-bit float that is the X-axis duration of the waveform that is displayed. For time domain waveforms, it is the duration of time across the display. If the value is zero then no data has been acquired.

X Display Origin A 64-bit double that is the X-axis value at the left edge of the display. For time domain waveforms, it is the time at the start of the display. This value is treated as a double precision 64-bit floating point number. If the value is zero then no data has been acquired.

X Increment A 64-bit double that is the duration between data points on the X axis. For time domain waveforms, this is the time between points. If the value is zero then no data has been acquired.

X Origin A 64-bit double that is the X-axis value of the first data point in the data record. For time domain waveforms, it is the time of the first point. This value is treated as a double precision 64-bit floating point number. If the value is zero then no data has been acquired.

X Units A 32-bit integer that identifies the unit of measure for X values in the acquired data:

- 0 = Unknown.
- 1 = Volts.
- 2 = Seconds.
- 3 = Constant.
- 4 = Amps.
- 5 = dB.
- 6 = Hz.

Y Units A 32-bit integer that identifies the unit of measure for Y values in the acquired data. The possible values are listed above under “X Units”.

Date A 16-byte character array, left blank in the 6000 Series oscilloscope.

Time A 16-byte character array, left blank in the 6000 Series oscilloscope.

Frame A 24 byte character array that is the model number and serial number of the oscilloscope in the format of:
MODEL#:SERIAL#.

Waveform Label A 16 byte character array that contains the label assigned to the waveform.

Time Tags A 64-bit double, only used when saving multiple segments (requires segmented memory option). This is the time (in seconds) since the first trigger.

Segment Index A 32-bit unsigned integer. This is the segment number. Only used when saving multiple segments.

Waveform Data Header

A waveform may have more than one data set. Each waveform data set will have a waveform data header. The waveform data header consists of information about the waveform data set. This header is stored immediately before the data set.

Waveform Data Header Size A 32-bit integer that is the size of the waveform data header.

Buffer Type A 16-bit short that is the type of waveform data stored in the file:

- 0 = Unknown data.
- 1 = Normal 32-bit float data.
- 2 = Maximum float data.
- 3 = Minimum float data.
- 4 = Not used in 6000 Series oscilloscopes.
- 5 = Not used in 6000 Series oscilloscopes.
- 6 = Digital unsigned 8-bit char data (for digital channels).

Bytes Per Point A 16-bit short that is the number of bytes per data point.

Buffer Size A 32-bit integer that is the size of the buffer required to hold the data points.

Example Program for Reading Binary Data

To find an example program for reading binary data, point your web browser to www.agilent.com/find/6000, select Library, and click “Example Program for Reading Binary Data”.

Examples of Binary Files

Single Acquisition Multiple Analog Channels

The following picture shows a binary file of a single acquisition with multiple analog channels.

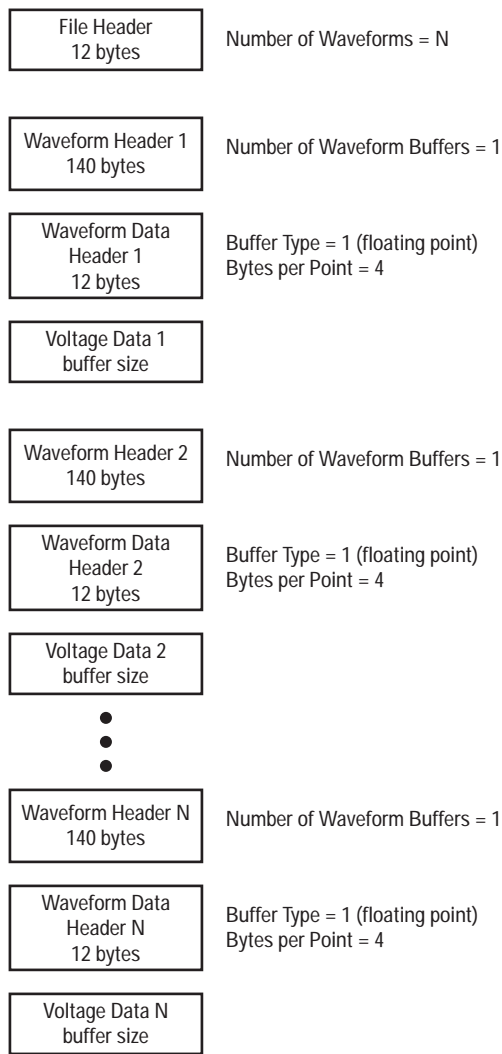

Single Acquisition All Pods Logic Channels

The following picture shows a binary file of a single acquisition with all pods for the logic channels saved.

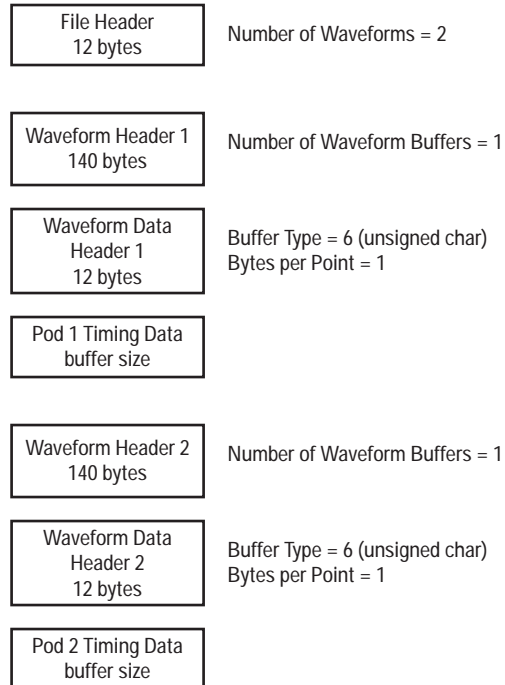

CSV and ASCII XY files

CSV and ASCII XY file structure

In CSV or ASCII XY format the **Length** control selects the number of points per segment. All segments are contained in the CSV file or in each ASCII XY data file.

For example: If the Length control is set to 1000 points, there will be 1000 points (rows in the spreadsheet) per segment. When saving all segments there are three header rows, so the data for the first segment starts at row 4. The second segment's data starts at row 1004. The time column shows the time since the trigger on the first segment. The top row shows the selected number of points per segment.

BIN files are a more efficient data transfer format than CSV or ASCII XY. Use this file format for fastest data transfer.

Minimum and Maximum Values in CSV Files

If you are running a Quick Measurement Minimum or Maximum measurement, the minimum and maximum values shown in the Quick Measurement display may not appear in the CSV file.

Explanation:

When the oscilloscope's sample rate is 4 GSa/s, a sample will be taken every 250 ps. If the sweep speed is set to 100 ns/div, there will be 1000 ns of data displayed (because there are ten divisions across the screen). To find the total number of samples the oscilloscope will take:

$$1000ns \times 4Gsa/s = 4000samples$$

For measurement data, the oscilloscope will decimate the 4000 points to 1000 points that will fit on the display. This decimation will not lose track of the min and max values at each of the 1000 horizontal data points, and min and max values will be displayed on screen. However, the oversampled data is also processed to provide a best-estimate value at each of the 1000 horizontal points. The data in the CSV file will be the

best-estimate value at each of the 1000 horizontal points. Therefore, the min and max values may not appear in the CSV file.

This occurs when oversampling occurs
(10 * seconds per division * maximum sample rate > 1000).

VPT1000 IP address and firmware updates

Changing the VPT1000 network settings

To change the Network setting of the VPT1000 Hardware, the Firmware Configuration Tool must be installed on a host PC. This software can be downloaded from: <http://www.agilent.com/find/vpt1000>. Select Technical Support, then select Drivers & Software.

Start the VPT1000 Firmware Configuration Tool. Access it via Start->Programs->Agilent VPT1000->VPT1000 Firmware Configuration Tool.

Connect to the VPT1000 Hardware unit to the host PC either via USB or via Ethernet (use the default IP address 192.168.80.80 if no other setting was previously applied).

If the connect is successful, you can access the network settings via the “Network Settings” button in the “Advanced Hardware controls” group. To change the address, type the proper values in the dialog, and press “Set New Configuration“. Upon success, you will see a confirmation dialog. Note that these changes do not take effect until after a reset of the VPT1000 hardware unit.

The VPT1000 Hardware can be restarted with the new network settings by cycling power. After reboot the Ethernet connection with the new settings is available. The IP address in the VPT1000 PC Software must match with the IP address configured in the VPT1000 Hardware.

Updating the VPT1000 firmware

The VPT1000 firmware can be downloaded from:
<http://www.agilent.com/find/vpt1000>. Select Technical Support, then select Drivers & Software. The firmware is also included on the Software installation CD. The firmware file exhibits the file extension .fwu.

To update the firmware:

- 1 Start Firmware Update Tool.
- 2 Select USB or enter IP address of VPT1000 Hardware and press Connect.
- 3 Select the firmware update file (firmware image) using the Browse Button in the Firmware Update area.
- 4 Start firmware update by pressing the Update button in the Firmware Update area.
- 5 Wait until firmware update is completed and firmware and hardware information is printed in the text box Info.

Do not disconnect VPT1000 Hardware during the firmware update process!

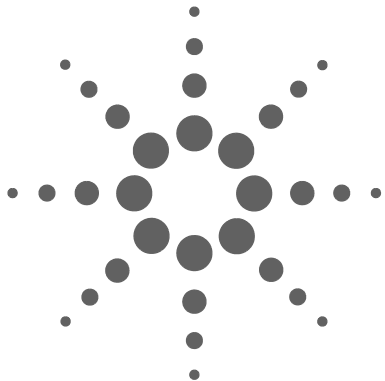

9

Power and Environmental Conditions

Power Requirements	402
Measurement Category	403
Environmental Conditions	405
Specifications	406
Acknowledgements	406
Contact us	407

This chapter describes the power requirements and environmental conditions appropriate for the Agilent InfiniiVision 6000 Series oscilloscopes.



Power Requirements

Line voltage, frequency, and power

~Line 100-120 Vac, 50/60/400 Hz
100-240 Vac, 50/60 Hz
120 W max

Measurement Category

Measurement Category

The 6000 Series oscilloscope is intended to be used for measurements in Measurement Category I.

WARNING

Use this instrument only for measurements within its specified measurement category.

Measurement Category Definitions

Measurement category I is for measurements performed on circuits not directly connected to MAINS. Examples are measurements on circuits not derived from MAINS, and specially protected (internal) MAINS derived circuits. In the latter case, transient stresses are variable; for that reason, the transient withstand capability of the equipment is made known to the user.

Measurement category II is for measurements performed on circuits directly connected to the low voltage installation. Examples are measurements on household appliances, portable tools and similar equipment.

Measurement category III is for measurements performed in the building installation. Examples are measurements on distribution boards, circuit-breakers, wiring, including cables, bus-bars, junction boxes, switches, socket-outlets in the fixed installation, and equipment for industrial use and some other equipment, for example, stationary motors with permanent connection to the fixed installation.

Measurement category IV is for measurements performed at the source of the low-voltage installation. Examples are electricity meters and measurements on primary overcurrent protection devices and ripple control units.

Transient Withstand Capability

CAUTION



Maximum input voltage for analog inputs

CAT I 300 Vrms, 400 Vpk; transient overvoltage 1.6 kVpk

CAT II 100 Vrms, 400 Vpk

with N2863A 10:1 probe: CAT I 600 V, CAT II 300 V (DC + peak AC)

with 10073C 10:1 probe: CAT I 500 Vpk, CAT II 400 Vpk

with 50 Ω input: 5 Vrms

CAUTION



Do not exceed 5 Vrms in 50 Ω mode on the 2-channel models. Input protection is enabled in 50 Ω mode, and the 50 Ω load will disconnect if greater than 5 Vrms is detected. However, the input could still be damaged, depending on the time constant of the signal. The 50 Ω input protection mode only functions when the oscilloscope is powered on.

Environmental Conditions

Environment Indoor use only.

Ambient temperature Operating 0 °C to +55 °C;
non-operating -40 °C to +70 °C

Humidity Operating 95% RH at 40 °C for 24 hr; non-operating
90% RH at 65 °C for 24 hr

Altitude Operating to 4,570 m (15,000 ft); non-operating to
15,244 m (50,000 ft)

Overvoltage Category This product is intended to be powered
by MAINS that comply to Overvoltage Category II, which is
typical of cord-and-plug connected equipment.

Pollution Degree The 6000 Series Oscilloscope may be operated
in environments of Pollution Degree 2 (or Pollution Degree 1).

Pollution Degree Definitions Pollution Degree 1: No pollution or
only dry, non-conductive pollution occurs. The pollution has no
influence. Example: A clean room or climate controlled office
environment.

Pollution Degree 2. Normally only dry non-conductive pollution
occurs. Occasionally a temporary conductivity caused by
condensation may occur. Example: General indoor
environment.

Pollution Degree 3: Conductive pollution occurs, or dry,
non-conductive pollution occurs which becomes conductive due
to condensation which is expected. Example: Sheltered outdoor
environment.

Specifications

Please see the InfiniiVision 6000 Series Oscilloscopes Data Sheet for complete, up-to-date specifications and characteristics.

To download a copy of the data sheet please visit: www.agilent.com/find/6000 and select **Library**, then select **Specifications**.

Or go to the Agilent home page at www.agilent.com and search for **6000 series oscilloscopes data sheet**.

To order a data sheet by phone, please contact your local Agilent office. The complete list is available at: www.agilent.com/find/contactus

Acknowledgements

RealVNC is licensed under the GNU General Public License. Copyright (C) 2002-2005 RealVNC Ltd. All Rights Reserved.

This is free software; you can redistribute it and/or modify it under the terms of the GNU General Public License as published by the Free Software Foundation; either version 2 of the License, or (at your option) any later version.

This software is distributed in the hope that it will be useful, but WITHOUT ANY WARRANTY; without even the implied warranty of MERCHANTABILITY or FITNESS FOR A PARTICULAR PURPOSE. See the GNU General Public License for more details. The license is located on the Agilent InfiniiVision 6000 Series Oscilloscopes Programmer's Documentation CD-ROM.

RealVNC source code can be obtained from RealVNC or by contacting Agilent. Agilent will charge for the cost of physically performing the source distribution.

Contact us

Americas

Canada (877) 894-4414
Latin America 305 269 7500
United States (800) 829-4444

Asia Pacific

Australia 1 800 629 485
China 800 810 0189
Hong Kong 800 938 693
India 1 800 112 929
Japan 81 426 56 7832
Korea 080 769 0800
Malaysia 1 800 888 848
Singapore 1 800 375 8100
Taiwan 0800 047 866
Thailand 1 800 226 008

Europe

Austria 0820 87 44 11
Belgium 32 (0) 2 404 93 40
Denmark 45 70 13 15 15
Finland 358 (0) 10 855 2100
France 0825 010 700
Germany 01805 24 6333*
*0.14€/minute
Ireland 1890 924 204
Italy 39 02 92 60 8484
Netherlands 31 (0) 20 547 2111
Spain 34 (91) 631 3300
Sweden 0200-88 22 55
Switzerland (French)
44 (21) 8113811 (Opt 2)
Switzerland (German)
0800 80 53 53 (Opt 1)
United Kingdom 44 (0) 7004 666666
Other European countries:
www.agilent.com/find/contactus

Index

Symbols

- (-)Width measurement, 257
- (+)Width measurement, 257

Numerics

- 1-2 math function, 223
- 232, 117
- 6000L, 9, 24

A

- About Oscilloscope, 116
- AC adapter, 41
- AC channel coupling, 92
- accessories, 25, 29, 30
- acquire, 280
- acquisition memory, 138
- acquisition mode, 277
 - averaging, 279, 280
 - high resolution, 278
 - normal, 278
 - peak detect, 278
- acquisition option
 - realtime, 281
- active probes, 61
- active serial bus, 305, 310, 315, 324, 340
- activity indicator, 126
- adding digital channels license, 376
- addition math function, 223
- address with no ack condition, I2C trigger, 171
- Addresses softkey, 43
- adjust the handle, 32
- aliasing, FFT, 229
- ALT, 117
- Amplitude measurement, 261

- AMS, 117
- AMS license, 116
- analog channel
 - probe attenuation, 94
 - setup, 90
- analog filters, adjusting, 229
- analog probes, 56
- analyze segments, 251, 285
- ASCII file format, 361
- attenuation factor, 88
- attenuation, probe, 94, 144
- Auto Increment, 359
- Auto trigger indicator, 75, 139
- auto trigger mode, 87, 139
- Auto? trigger indicator, 139
- AutoIP, 43
- automatic measurements, 103, 246
- automatic setup, 87, 124
- AutoProbe, 68, 74, 92
 - external trigger, 145
- AutoScale, 87
 - acquisition mode, 349
 - channels, 349
 - digital channels, 124
 - undo, 348
- autoscale key, 77
- auto-single, 86
- Average measurement, 262
- averaging acquire mode, 279, 280

B

- bandwidth limit, 93
- bandwidth, oscilloscope, 282
- Base measurement, 262
- BAT, 117
- BAT option, 39

- battery
 - charging, 41
 - life, 39
 - power indicator, 39
 - replacing, 41
- BIN file format, 361
- binary data (.bin), 388
- binary data file examples, 394
- binary data in MATLAB, 389
- binary data, example program for reading, 393
- bits, SPI trigger, 193
- Blackman Harris FFT, 232
- blanking, 102, 217
- BMP file format, 361
- brackets, 6000L, 36
- brightness of waveforms, 67, 73
- Browser Web Control, 50
- bus display mode, 130

C

- calibrate probe, 95
- CAN decode
 - source channels, 313
- CAN frame counter, 317
- CAN serial decode, 311
- CAN Signals Menu, 312
- CAN totalizer, 317
- CAN trigger, 156
- caution indicator, 39
- Center, FFT, 232

Index

- channel
 - analog, 90
 - bandwidth limit, 93
 - coupling, 92
 - invert, 93
 - on/off keys, 74
 - position, 91
 - probe units, 94
 - skew, 94
 - vernier, 91
 - vertical sensitivity, 91
- channel pair, 282
- charging indicator, 39, 41
- choosing values, 70
- cleaning, 381
- clear display, 273, 346
- clock, 110
- CMOS threshold, 129
- communicating with the oscilloscope, 42
- comparison of measurement results, 368
- compensate probes, 68, 73
- compensating your probe, 59
- Config softkey, 43
- connect probes
 - analog, 56
 - digital, 120
- connect the dots, 274
- connection
 - to a PC, 47
- connectivity, 42
- control oscilloscope, 377
- controls, front panel, 72, 79
- conventions, 70, 71
- Counter measurement, 254
- counter, CAN frame, 317
- counter, FlexRay frame, 334
- counter, UART/RS232 frame, 342
- coupling, channel, 92
- crossover cable, 25
- crosstalk problems, 229
- CSV file format, 361
- cursor measurements, 102, 238
- cursors
 - binary, 240
 - hex, 240
 - manual, 239
 - track waveform, 239
- D**
- D*, 128
- d/dt math function, 225
- damage, shipping, 25
- DC channel coupling, 92
- dead time (re-arm), 285
- default configuration, 118
- default label library, 109
- default setup, 118
- delay knob, 97
- Delay measurement, 258
- delay time indicator, 96
- delayed sweep, 98, 265
- delete character, 359
- delete file, 368
- DHCP, 43
- differentiate math function, 225
- Digit softkey, 155
- digital bus mode, 130
- digital channel controls, 73
- digital channel menu, 127
- digital channels, 9, 24, 83, 127
 - AutoScale, 124
 - display, 88
 - enabling, 376
 - logic threshold, 129
 - probing, 382
 - size, 128
- digital display, interpreting, 126
- digital probes, 120, 382
 - impedance, 382
- digital select key, 70
- dimensions, 6000L, 36
- display, 76, 82
 - area, 82
 - clear, 273
 - intensity, 83
 - interpreting, 82
 - measurement line, 82
 - modes, 273
 - signal detail, 275
 - softkeys, 82
 - status line, 82
 - vectors, 275
- display multiple acquisitions, 84
- distortion problems, 229
- DNS IP, 43
- domain, 43
- Domain softkey, 44
- download Quick Help language file, 64
- DSO, 4
- duration trigger, 161
- Duty cycle measurement, 255
- E**
- ECL threshold, 129
- edge triggering, 148
- EEPROM data read, I2C trigger, 172
- energy of a pulse, 227
- Entry knob, 70, 71, 76
- expand about, 91, 112, 271
- expand about center, 112
- expand about ground, 112
- exporting waveform, 356
- external memory device, 67, 73
- external trigger
 - input impedance, 145, 146
 - probe attenuation, 144
 - probe settings, 144
 - probe units, 146
- eye diagrams, 281
- F**
- f(t), 220
- factory default configuration, 118
- Fall time measurement, 256

- FFT measurements, 229
 - FFT window, 232
 - file
 - save, recall, load, 368
 - file browser, save to, 357
 - file explorer, 357, 368
 - using, 371
 - file format
 - ASCII, 361
 - BIN, 361
 - BMP, 361
 - CSV, 361
 - PNG, 361
 - file keys, 74
 - file name, new, 358
 - firmware updates, 376
 - firmware version information, 48
 - Flat top window, 232
 - FlexRay frame counter, 334
 - FlexRay serial decode, 331
 - FlexRay totalizer, 334
 - FlexRay trigger, 164
 - format
 - waveform, 360
 - FPG, 117
 - frame mode
 - segmented memory, 283
 - frame trigger, I2C, 172, 173
 - Frequency measurement, 255
 - front panel, 9, 24
 - language overlay, 31
 - front-panel, 72, 79
 - overview, 65
 - FRS, 117
- G**
- g(t), 220
 - gateway IP, 43
 - glitch trigger, 150
 - GPIB control, 377
 - grabber, 121, 122
 - graphic conventions, 71
 - graphical user interface languages, 64
 - graticule, 83
 - grid intensity, 83
 - ground level, 91
 - ground post, 39
 - ground wire, 39
- H**
- handle, 32
 - Hanning window, 232
 - HDTV trigger, 193
 - hex bus trigger, 155
 - Hex softkey, 155
 - HF Reject, 141, 343, 344
 - high-frequency noise rejection, 343, 344
 - high-resolution mode, 278
 - holdoff, 142
 - horizontal delay control, 75
 - horizontal menu/zoom key, 76
 - Horizontal section, 95
 - horizontal time/div control, 76
 - horizontal vernier, 96
 - host name, 48
 - hostname, 43
 - hysteresis, trigger, 344
- I**
- I/O port configuration, 377
 - I2C serial decode, 302
 - I2C Signals Menu, 303
 - I2C trigger, 169
 - idle serial bus, 305, 310, 315, 324, 340
 - Imped softkey, 92
 - impedance
 - digital probes, 382
 - external trigger, 146
 - increment statistics, 251
 - indeterminate state, 240
 - indicator
 - LAN status, 67
 - indicators, battery-powered
 - oscilloscopes, 39
 - infinite persistence, 84, 273, 345
 - infrequent triggers, 281
 - input impedance
 - channel input, 92
 - external trigger, 146
 - input voltage, 57, 145
 - instantaneous slope of a waveform, 225
 - Integrate math function, 227
 - intensity control, 67, 73, 83
 - invert, 93
 - invert graticule colors, 362
 - IP address, 43, 48
- K**
- Knob softkey, 101
- L**
- label key, 74
 - label list, 108
 - label list, loading from text file, 108
 - labels, 105
 - default library, 109
 - LAN connection, 43, 45
 - LAN control, 377
 - LAN reset, 45
 - LAN Settings softkey, 43
 - LAN status indicator, 67
 - landscape mode, 354
 - language, Quick Help, 64
 - languages
 - graphical user interface, 64
 - length control, 363
 - length softkey, 363
 - LF Reject, 344
 - library, labels, 106
 - licenses, 116, 376
 - LIN serial decode, 319
 - LIN Signals Menu, 320
 - LIN trigger, 177
 - LMT, 117
 - load file, 368
 - localized front panel overlay, 31
 - Location, 357

Index

logic threshold, 129
low-frequency noise rejection, 344
LSS, 117
LSS license, 116

M

Main/Delayed, 76
mask test
 trigger output, 291
mask testing, 287
math
 1², 221
 1-2, 223
 addition, 223
 differentiate, 225
 FFT, 229
 functions, 219
 functions on arithmetic operations, 220
 integrate, 227
 measurements, 261
 multiply, 221
 offset, 220
 scale, 220
 subtract, 223
 units, 220, 221
 using waveform math, 219
math key, 74
MATLAB binary data, 389
Maximum measurement, 262
maximum sample rate, 282
measure keys, 76
measurement category
 definitions, 403
measurement definitions, 254
measurement line, 82
measurement statistics, 249
measurement thresholds, 252
measurements, 103, 351
MegaZoom III, 4
mem2M, 117
mem2M license, 116
mem8M, 117
mem8M license, 116

memory
 segmented, 283
memory depth, 85
 upgrade, 376
Menu/Zoom key, 76
Minimum measurement, 262
missing acknowledge condition, I2C
 trigger, 171
Mode/Coupling key, trigger, 138
model number, 48
Modify softkey, 43, 44
mounting 6000L, 36
MSO, 4, 117
MSO feature upgrade, 376
MSO license, 116
MST, 249
Multiply math function, 221
multiply math function, 221

N

N5429A 12V DC automotive adapter
 cable, 41
navigate files, 368
network
 connecting to, 43
network configuration parameters, 48
network status information, 48
new label, 107
noise
 high-frequency, 343, 344
 low-frequency, 344
noise reject, 141
normal acquire mode, 278
normal horizontal mode, 95
Normal trigger mode, 75, 87, 140
Nth Edge 2, 185
Nth Edge 2 (no re-find), 186
Nth edge burst triggering, 175

O

option SEC, 372
options, print, 354

overlay, localized, 31
Overshoot measurement, 267
overvoltage category, 405

P

palette, 362
pan and zoom, 86, 270, 271
parts, replacement, 387
passive probes, 60
password
 reset, 52
 set, 51
pattern
 duration trigger, 161
 pattern trigger, 153
 SPI trigger, 193
pattern trigger, 153
PC connection, 47
peak detect acquire mode, 278, 345
Peak-peak measurement, 262
Period measurement, 256
persistence, infinite, 84
Phase measurement, 259
PNG file format, 361
point-to-point connection, 47
pollution degree, 405
 definitions, 405
position, analog, 91
post-processing, 213
power switch, 38, 40, 67, 73
power-on, 38
predefined labels, 106
Preset, FFT, 231
Preshoot measurement, 266
Press to go, 357
print, 109, 352
 landscape, 354
 Quick Print, 352
Print key, 109
print options, 354
print screen, 352
printer
 USB, 352, 355

- printers
 - supported, 355
 - printing the display, 352
 - probe
 - AutoProbe interface, 68, 74
 - calibrate, 95
 - probe attenuation, 94, 144
 - probe compensation, 68, 73
 - probe factor, 88
 - probe units, 94, 146
 - probes, 30
 - active, 61
 - analog, 56
 - compensating, 59
 - digital, 120
 - passive, 60
 - pulse polarity, 151
 - pulse width trigger, 150
 - PWR, 117
- Q**
- qualifier, 151
 - Quick Help, 63
 - Quick Help language, 64
 - Quick Meas, 103, 246
 - Quick Print, 109, 352
 - Quick Print key, 353
- R**
- random noise, 343
 - ratio measurement, 262
 - realtime acquire option, 281
 - Realtime sampling and bandwidth, 282
 - re-arm time, 285
 - recall waveform, 368
 - recall waveform and setup, 368
 - record length, 85
 - Rectangular window, 232
 - remote control, 42
 - remote display, web, 48
 - Remote Front Panel, 50
 - remote interface, 42
 - replacement parts, 387
 - reset LAN, 45
 - restart condition, I2C trigger, 171
 - return instrument for service, 381
 - Rise time measurement, 257
 - RMS measurement, 263
 - roll mode, 100
 - run controls, 75
 - Run/Stop key, 84
 - runt pulses, 256
- S**
- sample rate, 5, 278, 282
 - current rate displayed, 95
 - save
 - browse to destination, 357
 - execution time, 364
 - formats, 360
 - settings, 362
 - save file, 368
 - save segment, 364
 - Save to, 357
 - save trace
 - to scope memory, 368
 - to USB, 366
 - save waveform
 - to scope memory, 368
 - to USB, 366
 - saver, screen, 111
 - saving
 - serial decode data, 360
 - saving data, 356
 - SCL, I2C trigger, 170
 - screen saver, 111
 - SDA, 169
 - SDA, I2C trigger, 170
 - SEC, 117
 - SEC, option, 372
 - secure environment mode, 372
 - segmented memory, 283
 - re-arm time, 285
 - save time, 364
 - saving segments, 364
 - statistical data, 285
 - selecting
 - digital channels, 70
 - values, 70
 - Self Test, service, 116
 - sequence trigger, 181
 - serial clock, I2C trigger, 170
 - serial data, 169
 - serial data, I2C trigger, 170
 - serial decode, 301, 363
 - saving data, 360
 - serial number, 48
 - service functions, 113
 - Set all Digits softkey, 155
 - setup, automatic, 87, 124
 - setup, default, 118
 - SGM, 117, 283
 - shipping damage, 25
 - shipping precautions, 381
 - Sigma, minimum, 289
 - single acquisition, 75, 85
 - Single key, 85
 - size, 128
 - skew, analog channel, 94
 - slope trigger, 148
 - softkeys, 9, 70, 77, 82
 - software updates, 376
 - source frequency, 212
 - Span, FFT, 232
 - specifications, 406
 - spectral leakage, FFT, 231
 - SPI serial decode, 306
 - SPI Signals Menu, 307, 337
 - SPI trigger, 188
 - square root, 236
 - stage, sequence, 183
 - stand-alone connection, 47
 - start acquisition, 75, 84
 - start condition, I2C, 171

Index

- statistics
 - increment, 251
 - measurement, 249
 - using segmented memory, 285
- status line, 82
- status, User Cal, 115
- Std Deviation measurement, 263
- stop acquisition, 75, 84
- stop condition, I2C, 171
- subnet mask, 43
- Subtract math function, 223
- sweep speed vernier, 96
- symbols, graphic, 71
- sync polarity, TV trigger, 195

T

- template, front panel, 31
- threshold
 - analog channel measurements, 252
 - digital channels, 129
- tilt for viewing, 32
- time
 - re-arm, 285
- time measurements, 254
- time reference, 96
- time reference indicator, 96
- time, save execution, 364
- timebase, 95
- Top measurement, 265
- totalizer, CAN, 317
- totalizer, FlexRay, 334
- totalizer, UART/rs232, 342
- trace
 - save to scope memory, 368
 - save to USB, 366
- tracking cursors, 239
- transient withstand capability, 404
- Trig'd trigger indicator, 140
- Trig'd? trigger indicator, 140

- trigger
 - coupling, 141
 - external, 144
 - HF Reject, 141
 - holdoff, 142
 - hysteresis, 344
 - mode, 138
 - mode/coupling, 138
 - noise reject, 141
 - source, 149
- trigger controls, 75
- trigger indicator
 - Auto, 139
 - Auto?, 139
 - Trig'd, 140
 - Trig'd?, 140
- trigger mode
 - auto, 87, 139
 - normal, 87, 140
- Trigger Out connector, 212
- trigger output
 - mask test, 291
- trigger type, 147
 - CAN, 156
 - duration, 161
 - edge, 148
 - FlexRay, 164
 - glitch, 150
 - hex bus, 155
 - I2C, 169
 - LIN, 177
 - Nth edge burst, 175
 - pattern, 153
 - pulse width, 150
 - sequence, 181
 - slope, 148
 - SPI, 188
 - TV, 193
 - UART/RS232, 205
 - USB, 210
- triggers, 212
- TTL threshold, 129
- turn channel on, 74
- TV trigger, 193

U

- UART totalizer, 342
- UART/RS232 frame counter, 342
- UART/RS232 license, 117
- UART/RS232 serial decode, 336
- UART/RS232 trigger, 205
- undo AutoScale, 87
- units, math, 220, 221
- units, probe, 94, 146
- unstable triggers, 281
- updating software and firmware, 376
- upgrading the oscilloscope, 376
- upload new firmware, 48
- USB
 - CD device, 369
 - device port, 353
 - printer, 353
 - storage device numbering, 369
- USB control, 377
- USB ports, 67, 73
- USB trigger, 210
- USB, eject device, 67, 69, 73
- USB0, 369
- USB5, 369
- user cal, 113
- User-defined threshold, 129
- utility key, 75

V

- values, choosing, 70
- vectors, 274, 275
- ventilation requirements, 37
- vernier, channel, 91
- vernier, sweep speed, 96
- vertical expansion, 91
- vertical position, 91
- vertical position control, 74
- vertical sensitivity, 74, 91
- viewing signals, 275
- viewing, tilt the instrument, 32
- VISA connect string, 48
- voltage measurements, 260

VPT1000, 164, 325

W

warranted specifications, 406

warranty, 380

waveform

 cursor tracking, 239

 printing, 352

 recall, 368

 save to scope memory, 368

 save to USB, 366

 saving and exporting, 356

waveform keys, 75

waveform reference point, 112

waveform save options, 362

Web browser, 42

Web control, 9, 24

web interface, 48

Width - measurement, 257

Width + measurement, 257

Window, FFT, 232

X

X and Y cursors, 241

X at Max Y measurement, 257

X at Max Y on FFT, 254

X at Min Y measurement, 258

X at Min Y on FFT, 254

XY mode, 101, 214

Y

Y and X cursors, 241

Z

Z-axis blanking, 102, 217

zoom and pan, 86, 270, 271

Zoom mode, 98

